

Cawandi Ministeroo

Mali Gandaa

Jama foo - Anniya foo - Addin foo

I.P.N. - DNAFLA
BAMAKO

KABUBAYRAY

1

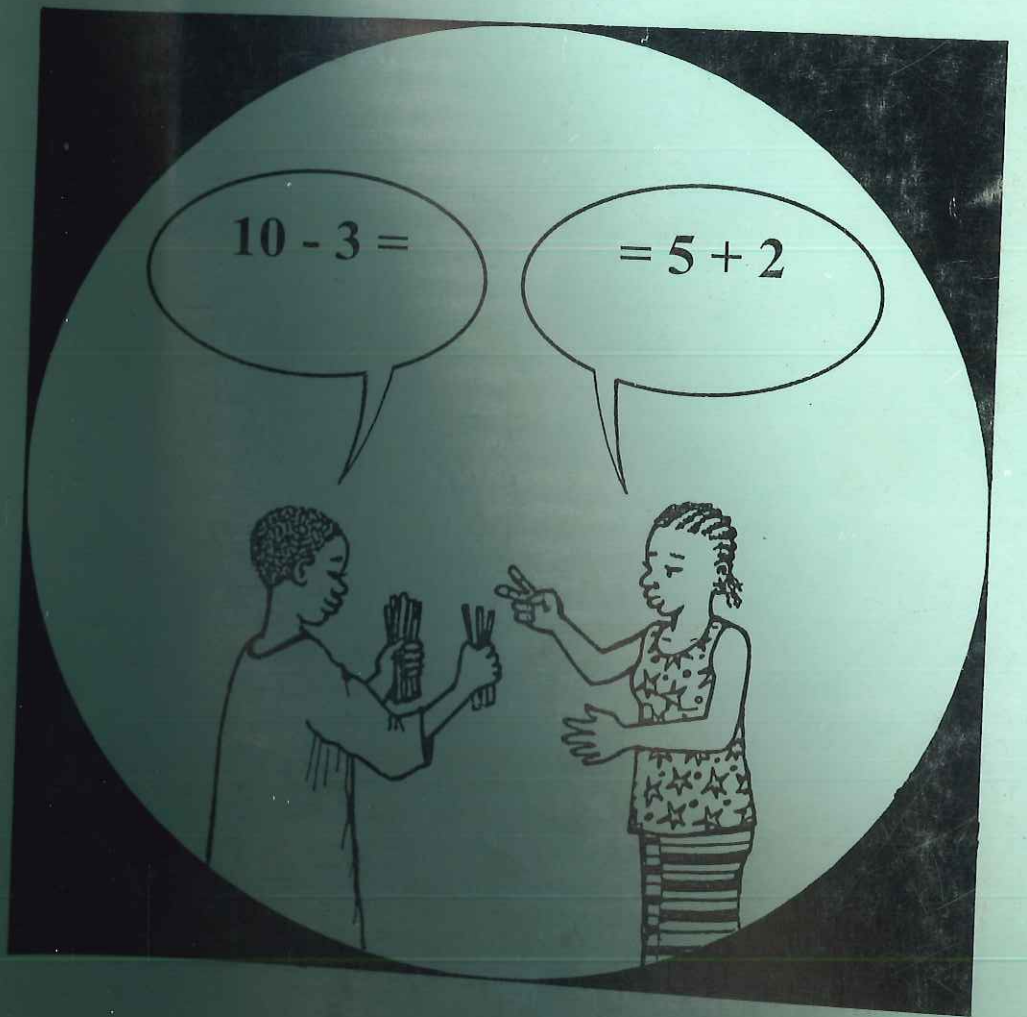

KABUBAYRAY 1

CAWBOŊEY

| | moo |
|--|-----|
| Yaamar | 1 |
| Jiri jinaa goy soolantaa | 3 |
| Jirbi iyyaa goy soolantaa | 8 |
| Kabu jine goy | 11 |
| Ibaay suubayan nda kani-kanandiyan | 12 |
| Suubayan goyjinawey dumey bande | 14 |
| Suubayan sii wala beeray wala noonay bande | 16 |
| Suubayan alhaali hinka bande | 19 |
| Kani-kanandiyan | 21 |
| Filla | 23 |
| Tenjandiyan | 24 |
| Suuba-suubayan doona | 28 |
| Hanga-hangandiyan | 30 |
| Filla | 32 |
| Hinnabayray | 34 |
| 1 ka koy 9 hinnawey | 35 |
| 1 ka koy 9 hanga-hangandi cere bande | 42 |
| 1 ka koy 9 hinnawey fesu-fesuyanoo | 46 |
| 0 nda 10 hinnawey | 50 |
| 0 ka koy 10 hinnawey | 55 |
| Filla : 0 ka koy 10 | 58 |
| Tontonyan maanaa | 62 |
| 10 ka koy 19 hinnawey | 69 |
| Tontonyan maanaa nda teeyanoo | 73 |
| 20 hinnaa | 77 |
| Hinna bayray iwoy boŋ ra | 81 |
| Tontonyan kaŋ sii nda lanbari | 86 |
| 20 ka koy 29 hinnawey | 90 |
| Misey kaŋ ra tontonyan ga tee (20 ka koy 29) | 100 |
| 30 hinnaa | 105 |
| Filla : 0 ka koy 30 hinnawey | 110 |
| Kaayan maanaa | 113 |
| 30 ka koy 39 hinnawey | 117 |
| Kaayan maanaa nda teeyanoo | 120 |
| 40 hinnaa | 123 |
| Kaayan bila lanbari | 127 |
| 40 ka koy 49 hinnawey | 130 |
| Mise kaŋ ra kaayan ga tec (40 ka koy 49) | 134 |
| 50 hinnaa | 137 |
| Filla : 50 hinnaa | 142 |
| Tontonyan kaŋ goo nda lanbari (0 ka koy 50) | 143 |
| 50 ka koy 59 hinnawey | 146 |

| | |
|--|-----|
| Kaayan kan goo nda lanbari (50 ka koy 59) | 152 |
| 60 hinnaa | 155 |
| Tontonyan bila lanbari wala nda lanbari (60 hinnaa) | 159 |
| 60 ka koy 69 hinnawey | 162 |
| Kaayan bila lanbari wala nda lanbari (60 ka koy 69 hinnawey) | 168 |
| 70 hinnaa | 172 |
| Filla : 0 ka koy 70 hinnawey | 176 |
| Tontonyan nda kaayan mise folloku ra : 70 hinnaa | 178 |
| 70 ka koy 79 hinnawey | 180 |
| Tontonyan nda kaayan : 70 ka koy 79 hinnawey | 184 |
| 80 hinnaa | 187 |
| Tontonyan nda kaayan : 80 hinnaa | 190 |
| 80 ka koy 89 hinnawey | 193 |
| Tontonyan nda kaayan : 80 ka koy 89 hinnawey | 197 |
| 90 hinnaa | 200 |
| 90 ka koy 99 hinnawey | 203 |
| Tontonyan nda kaayan : 90 ka koy 99 hinnawey | 206 |
| 100 hinnaa | 209 |
| Filla : 100 hinna | 212 |
| 100 hinna fesu-fesuyanoo | 215 |
| Doobayray | 217 |
| Jine – banda | 218 |
| Kanbe guma – kanbe wowa | 220 |
| Kuna ra – taray | 222 |
| Beene – ganda, beene here – ganda here | 226 |
| Boŋ – cire ; beene – ganda | 229 |
| Filla : kanbe wowa, kanbe guma, jine, banda | 232 |
| Kanbe guma here – kanbe wowa here | 236 |
| A ga man a – a ga moor'a | 239 |
| Game | 242 |
| Zeeri feerante – zeeri daabante | 245 |
| Filla : kanbe guma here, kanbe wowa, a ga man a, a ga moor'a, game, zeeri feerante, zeeri daabante | 247 |
| Biibayray | 248 |
| Caaray nda kanandiyan | 249 |
| Zeeri teeyan | 253 |
| Zeeri dunbu teeyan | 254 |
| Filla : caaray nda kanandiyan, zeeri dunbu teeyan, zeeri teeyan | 257 |
| Neesiyan | 259 |
| Kuuyan | 260 |
| Kuntur | 263 |
| Nooru | 264 |
| Filla : Kuuyan, kuntur, nooru | 269 |
| Hooray | 271 |
| Kalimawey | 273 |
| Tiirawey kan gunandi | 276 |

Wallafikey

| | | |
|-----------------|----------|------------|
| Yuusuf | M. | Haydara |
| Yuusuf | B. | Mayga |
| Mahammadu Bappa | | Mayga |
| Abdulbaaki | A. | Mayga |
| Berehima | | Ulale |
| Amadu | | Yatara |
| Bubakirin | | Tuure |
| Haamidu | | Mayga |
| Alhamdu | | Runba |
| Ibrahim | A. | Tarawore |
| Abdullahi | | Alasan |
| Alasan | | Mucaari |
| Ahamar | | Mayga |
| Seydu | | Kulibali |
| Mufuliha | | Haamidu |
| Bubakar | | Mayga |
| Aysata | | Maaliki |
| Bilal | | Bujuma |
| Aliyyu | | Boŋkaana |
| Abu | Mahamar | Mayga |
| Ahuudu | O. | Mayga |
| Ibrahim | Jibirila | Mayga |
| Muusa | | Izeceeguma |
| Umar | Asaydu | Tuure. |

Biiteekey

Amadu Sanogo

Mahammar A. Mayga

Amidu Kojo

Abdullay Mayga

Hammadun Siise

Umar A. Mayga

Tijan Tarawere

Manša Kamara

Yaamar

Kabubayray tiiraa woo kaɗ wallafandi mana tee haya se kala goyoo ma don alfagaa nda taalibey se. Woo se ir ga wiri alfagaa ga a ma goy nda yaamarey wey.

Hõ zaaroo, sikka sii kaɗ kabubayray mo ga zanka lakkal feeri. Woo se alfagaa ga hima ka duu fondayan nda goyjinayyan kaɗ ga cawoo doonandi hala taaliboo m'a boonay. Jiiri jinaa tiiraa woo mana tee kala alfagaa nda taalibey kul se ; amma alfagaa ma gaabandi taalibey masi hantum a ra. Alfagaa ma bay kaɗ cawandoo si tee kala taalibey se ; saa din ngi no ma hima ka goyoo iberoo tee. Nongu kaɗ i mana hin ka bisa, alfagaa m'i faaba. Jirbiyye 25 ra goy soolantaa ga tee kaɗ zemna dunbu 4 :

- Kabu jine goy
- Hinnabayray
- Biibayray-doobayray
- Neesiyan.

Caw foo kul ga tee nda fondaa woo :

- Cawboɗ
- Taasiha
- Goyjinawey
- Kabu cahānte
- Goyey

- Zimamey (denden).

Kabu jine goy nda doobayray no ma jin hinnabayray se.

Kanje hinza bande goyoo ga tee :

- Ijinaa : ka goy nda jinawey

- Ithinkantoo : ka goyoo fasal nda bii

- Ihinzantoo : ka goyoo caw, k'a hantum ka duu nga bayraa.

Kanje hinzaa woo affoo kul si hima ka yalandi ; amma a mana waazibi kanje hinzaa woo kul ma tee caw foo ra.

Dendeney ga hin ka tee taalibi foo goy wala

kuray-kuray wala poroze.

Denden yaamarey* ga hima ka fahamandi. Alfagaa ma goy nda goyjinawey kaŋ goo kaboo cire.

Alfagaa ma jiiri goy soolantaa tee, a m'a benandi nda taka kaŋ nda taalibey ga hin a. Hoorayyaŋ mo goo tiiraa ra.

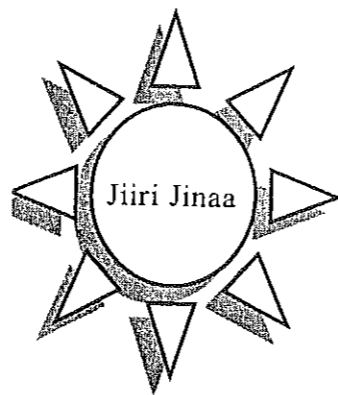

Programme de 1^{ère} année : Jiiri jinaa goy soolantaa

Tri et classement libre : ibaay suubayan nda

kani-kanandiyan

Tri selon la nature du matériel : suubayan goyjinay alhaali bande

Tri selon la forme, la taille, la couleur : suubayan taka, beeray wala noonay bande

Tri selon deux propriétés : suubayan alhaali hinka bande

Classements : kani-kanandiyan

Révision : filla

Correspondance terme à terme : tenjandiyan

Rythmes simples : suuba-suubayan doona

Rangement : hanga-hangandiyan

Révision : filla

Numération : Hinnabayray

Les nombres de 1 à 9 : 1 ka koy 9 hinnawey

Ordonner les nombres de 1 à 9 : 1 ka koy 9 hinnawey hanga-hangandiyan

Décomposition des nombres de 1 à 9 : 1 ka koy 9 hinnawey fesu-fesuyan

Les nombres 0 et 10 : 0 nda 10 hinnawey

Les nombres de 0 à 10 : 0 ka koy 10 hinnawey

Révision : filla

Principe de numération en base 10 : hinna margayan 10 ra

Addition (sens) : tontonyan (almaanaa)

Les nombres de 10 à 19 : 10 ka koy 19 hinnawey

Addition (sens et technique) : tontonyan (almaanaa nda teeyanoo)

Le nombre 20 : 20 hinnaa

Addition sans retenue : tontonyan bila lanbari.

Les nombres de 20 à 29 : 20 ka koy 29 hinnawey

Situations relatives à l'addition (problème) : misey kaṅ ra tontonyan ga tee

Le nombre 30 : 30 hinnaa

Révision : filla

Soustraction (sens) : kaayan (almaanaa)

Les nombres de 30 à 39 : 30 ka koy 39 hinnawey

Soustraction (sens, technique) : kaayan (almaanaa nda teeyanoo)

Le nombre 40 : 40 hinnaa

Soustraction sans retenue : kaayan bila lanbari

Les nombres de 40 à 49 : 40 ka koy 49 hinnawey

Situations relatives à la soustraction (problèmes) :

misey kaṅ ra kaayan ga tee (boṅhaw)

Le nombre 50 : 50 hinnaa

Révision : filla

Addition avec retenue : tontonyan kaṅ goo nda lanbari

Les nombres de 50 à 59 : 50 ka koy 59 hinnawey

Soustraction avec retenue : kaayan kaṅ goo nda lanbari

Le nombre 60 : 60 hinnaa

Addition sans ou avec retenue : tontonyan bila lanbari wala nda lanbari

Les nombres de 60 à 69 : 60 ka koy 69 hinnawey

Soustraction sans ou avec retenue : kaayan bila lanbari wala nda lanbari

Le nombre 70 : 70 hinnaa

Révision : filla

Addition , soustraction (situations combinées, problèmes) tontonyan nda kaayan mise folloku ra

Les nombres de 70 à 79 : 70 ka koy 79 hinnawey

Addition + soustraction : tontonyan nda kaayan

Le nombre : 80 hinnaa

Addition + soustraction : tontonyan nda kaayan

Les nombres de 80 à 89 : 80 ka koy 89 hinnawey

Addition + soustraction : tontonyan nda kaayan

Le nombre 90 : 90 hinnaa

Les nombres de 90 à 99 : 90 ka koy 99 hinnawey

Addition + soustraction : tontonyan nda kaayan

Le nombre 100 : 100 hinnaa

Révision : filla

Décomposition du nombre 100 : 100 hinnaa fesu-fesuyanoo

Addition et soustraction : tontonyan nda kaayan

Topologie-Géométrie : doobayray-biibayray

1. Topologie : doobayray

Devant - derrière : jine - banda

Gauche - droite : kanbe wowa -kanbe guma

Dedans - dehors ; intérieur - extérieur : kuna -taray

Sur - sous ; au dessus de-au dessous de : boṅ-cire ; beene- ganda

Haut-bas ; en haut, en bas : beene-ganda, beene here-ganda here.

Révision : filla
 A gauche : kanbe wowa here
 A droite : kanbe guma here
 Loin de : a ga moor'a
 Près de : a ga man a
 Avant - après : jine-banda
 Entre : game
 Ligne ouverte-ligne fermée : zeeri feerante - zeeri daabante
 Révision : filla

2. Géométrie : biibayray

Frise - pavage : caaray -kanandiyan
 Tracé de traits : zeeri teeyan
 Tracé de segments : zeeri dunbu teeyan
 Révision : filla

Mesure : Neesiyan

Longueur : kuuyan
 Masse : kuntur
 Monnaie : nooru
 Révision : filla
 Géométrie : biibayray
 Tracé de trait : zeeri teeyan
 Tracé de segment : zeeri dunbu teeyan
 Frise, pavage : caaray, kanandiyan
 Tableau à double entrée : daari mee hinka
 Révision : filla
 Symétrie par rapport à une droite : (bii) tenjandiyan zeeri ga.
 Le rectangle : muulubii

Le triangle : kanjehinza
 Le carré : kaare
 Révision : filla
 Le cercle : windira
 Les solides : sendi-sendey
 Révision : filla
 Mesures : neesirey
 Longueur : unités arbitraires : kuuyan; donkul neesijey
 Longueur : unités conventionnelles (mètre, demi-mètre, décamètre, hectomètre, kilomètre) : kuuyan waafaku neesijey (meetar, meetar-jere, dekameetar, hektomeetar, kilomeetar).
 Révision : filla
 Masse : unités arbitraires : kuntur donkul neesijey
 Masse : unités conventionnelles : (gramme, kilogramme)
 Kuntur : waafaku kuntur neesijey : garam, dekagaram, hektogaram, kilogaram
 Capacité : unités conventionnelles (litre, demi-litre) :
 Tooyan : waafaku neesijey (liitar, liitar jere, dekaliitar, hektoliitar)
 Révision : filla
 Monnaie (notions) : nooru (bayray sintin)
 Monnaie : pièces (5 F, 10 F, 50 F, 100 F, 250 F) : nooru guuru buuna (k 1, k 2, k 5, k 10, k 20, k 50).
 Monnaie : problèmes pratiques : yantasu feeray
 Monnaie : billet (500 F) : zangu fita (k 100)
 Monnaie : billet (1.000 F) zangu hinka fita (k 200)
 Monnaie : problèmes pratiques : yantasu feeray
 Révision : filla

KABU JINE GOY

| | | | | | |
|-----|--|---|--|------------------------|----------------|
| 15. | - Hinna : 60-69 - Filla | - Kaayan nda lanbari wala bila lanbari | | - Caaray kanandiyani | - Kuntur |
| 16. | - Hinna : 70 | - Tontonyan nda kaayan mise follolokaa ra | | - Zeeri teeyan | - Kuntur |
| 17. | - Hinna : 70-79 - Hinna : 80 - Hinna : 80-89 | - Tontonyan nda kaayan | | - Caaray kanandiyani | - Nooru |
| 18. | - Hinna : 80 - Hinna : 90 - Hinna : 90-99 | - Tontonyan nda kaayan | | - Caaray kanandiyani | - Nooru |
| 19. | - Hinna : 100 - 100 fesufesuyan | | - Tontonyan nda kaayan : bojhaw | | - Nooru |
| 20. | - Filla | - Tontonyan nda kaayan : Filla | - Tontonyan nda kaayan mise follolokaa ra : bojhaw | - Caaray kanandiyani | - Nooru |
| 21. | - Hinna : 50-59 - Filla | - Tontonyan kang goo nda lanbari : Filla | - Mise kang ra kaayan ga tee : Filla | - Zeeri teeyan : Filla | - Nooru |
| 22. | - Hinna : 0-100 | - Kaayan bila lanbari : Filla | - Mise kang ra tontonyan ga tee : Filla | - Caaray kanandiyani | - Kuuyan Filla |
| 23. | | | | | |
| 24. | | | | | |
| 25. | | | | | |

Caw : Ibaay suubayan nda kani-kanandiyān

Taasiha : taaliboo ma hin :

- ka jinayyaŋ suuba k'i kaa cere ra ;
- ka jinayyaŋ kani-kanandi.

Goyjinawey : tondi-ize, tuuri fita, bundu-ize, hayni, duuri, teenay guli, garbay guli, daaray guli.

Goyey

1. Alfagaa ma taalibey fattandi lokkol batumaa ra wala taray i ma goyjinay ceeci.

Laasaabu : fattayanoo nafaa ti zankey ma ngi windilaa bay ka boori.

2. Taalibey ma goyjinawey jisi ngi taabaley boŋ. Taabal foo kul zankey ma jin ka goy nda ngi boŋ.

Denden : Alfagaa ma nee taalibey se i ma goyjinawey kanandi ngi dumey bande.

- Alfagaa ma kurawey hãa nda goyoo kaŋ i n'a tee almaanaa.

Denden : Alfagaa ma kurawey kul yaamar i ma goyjinawey birji cere ra.

Denden : Zankey ma yee ka goyjinawey kanandi ngi alhaaley bande.

Goyjinay : sii foo kul ma huru nga bataa ra, a ma jisa cawhugoo kanje foo ra (wala sunduku sukantaa ra).

Duurandi

- Suubayan ti ka jinay dumi foo kaa jinayyaŋ ra.

- Kani – kanandiyar ti ka jinay himantey dam cere bande.

Denden

1. Taalibey ma tondiyar nda zeeriyar nda gunguliyar tee, i m'i naami.
 - X dam tonbey cire.
 - Zeerey koli affoo-foo .
2. - Gunguley koli.
 - Zeerey koli.
3. - Taalibey fay-fay : woyey nda arey.
 - Taalibey fay-fay : iduurawey, ikukey (ikaccey, ibeerey), imaryey.
4. - Taalibey kul ikaccaa suuba.
 - Taalibey kul ibeeroo suuba.
5. - Taalibey kan goo nda saaku dam jere ga.
 - Wey kan sii nda walha suuba.

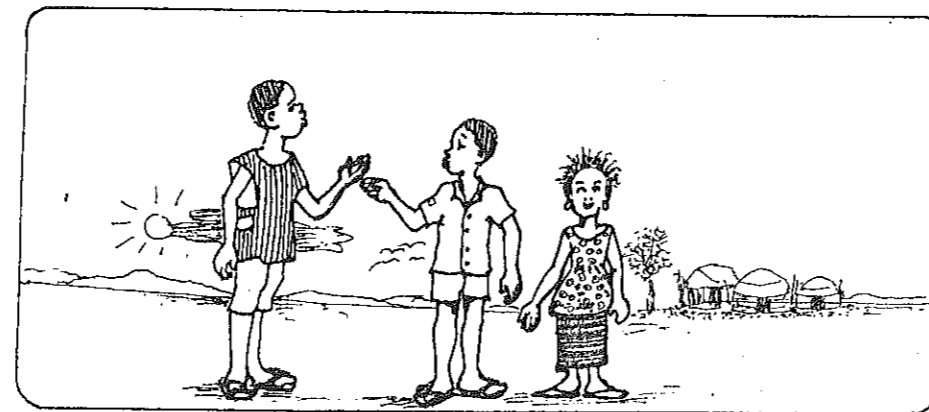

Caw : Suubayan goyjinawey dumey bande

Taasiha : Taaliboo ma hin :

- ka goyjinawey bay, a ma maayey har ;
- ka suubayan tee goyjinawey siyey bande.

Goyjinawey : Wey kan goo sunduku sukantaa ra.

Goyey

Goy jinaa : Alfagaa ma goyjinawey jisi taabaley boq. A ma taalibey nar i ma goy nda ngi boq.

Goy hinkantoo : Alfagaa ma goyjinay taaci (tondi-ize, garbay guli, bundu-ize, teenay guli) cebe affoo-foo taalibey se. Taalibey m'i maayey har.

Goy hinzantoo : Alfagaa ma ihinza cebe goyjinay taaca ra, a ma nee taalibey ma woo kan kuma maayoo har.

Goy taacantoo : Alfagaa ma nee taalibey ma biyey wey tee : hugu 2, kusu 3, tuuri 4 ; i ma X dam tuurey kul ga.

Goy guwantoo : Alfagaa ma willi goy hinzantoo ga, a ma nee taalibey ma goyjinay hinzaa kan a n'i cebe maayey har.

Goy idduwantoo : Alfagaa ma goyjinay iyey tana cebe taalibey se a ma nee i ma maayey har.

Goy iyyantoo : Alfagaa ma goyjinayyar (hinji, tinda, sokol, kusu) biyey cebe taalibey se, a ma nee i ma goyjinay sii foo suuba k'a kaa i ra.

Alfagaa ma nee taalibey ma willi goyoo ga cee boobo, i ga jinawey barmay-barmay.

Denden

1. Biyey wey tee, ma zeeri dam hinjey ga.

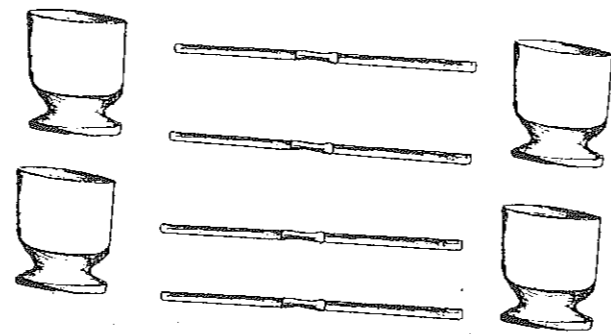

2. Biyey wey tee, ma tuurey koli.



3. Biyey wey tee ma X dam banaanawey ga.

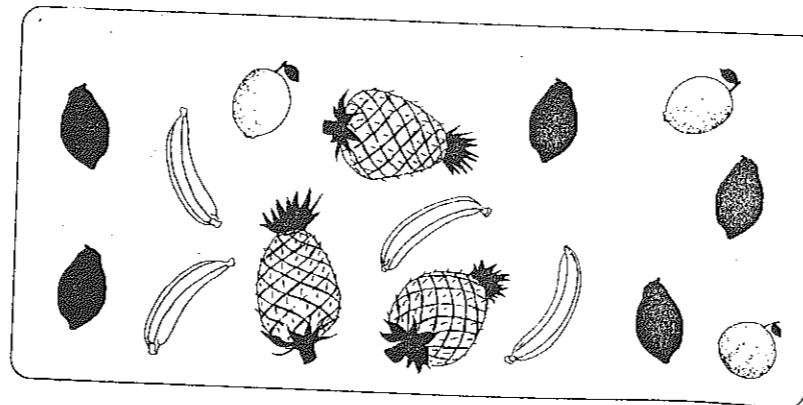

Caw : Suubayan, sii wala beeray wala noonay bande

Maasiha : Taaliboo ma hin :

- ka jinayyaŋ suuba ngi siyoo bande ;
- ka jinayyaŋ suuba ngi beeraa bande ;
- ka jinayyaŋ suuba ngi noonaa bande.

Goyjinawey : Bokotiyaŋ, batayaŋ, gaasuyaŋ, zootoyaŋ, lefeyaŋ, okolyaŋ, darbayaŋ.

Goyey

1. Alfagaa ma nee zankey ma goyjinawey kaŋ nda i kaa, jisi nga taabaloo boŋ. Alfagaa ma kuray hinza tee.

- Kuray jinaa : jinawey suuba ngi siyoo bande.

Denden : Bokoti hinza suuba m'i jisi jere ga.

- Kuray hinkantoo : jinawey suuba ngi beeraa bande.

Denden : Zanka kuku hinka nda iduuraw hinka suuba ma affoo kul kayandi jere ga.

- Kuray hinzantoo : jinawey suuba ngi noonaa bande.

Denden : Darbay ciray foo nda darbaya kara foo cebe ; darbaya firzi 2 nda darbaya boogu (bula) 2 cebe.

2. Alfagaa ma dooruyaŋ kaŋ mana ti noonay foo jisi nga taabaloo boŋ. A ma taalibey cee ihinka-hinka ; affaa ga dooruyaŋ zaa affoo-foo, affaa ga ngi noonawey har, a ga noonay foo kul jisi nga boŋ se.

3. Alfagaa ma kaare, nda muulubii, nda kanjehinza nda gunguliyaŋ biyey tee walhabeeroo ga. A ma noonayyaŋ dam i ga, a ma nee taalibey se :

- « bii ciray marje bara walhabeeroo ga ?
- bii kara marje bara walhabeeroo ga ?
- wa bii boogu 3 cebe walhabeeroo ga ! »

Denden

1. Biyey wey tee ma kanjehinza beeroo koli.

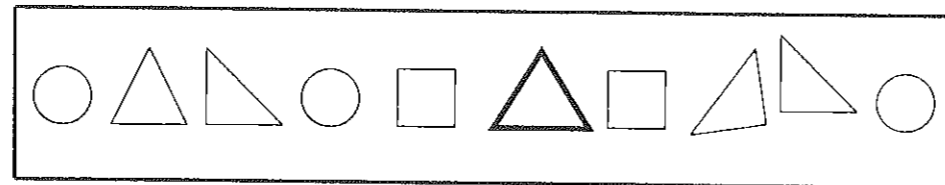

2. Biyey tee ma X dam kanjehinza kaccey kul ga.

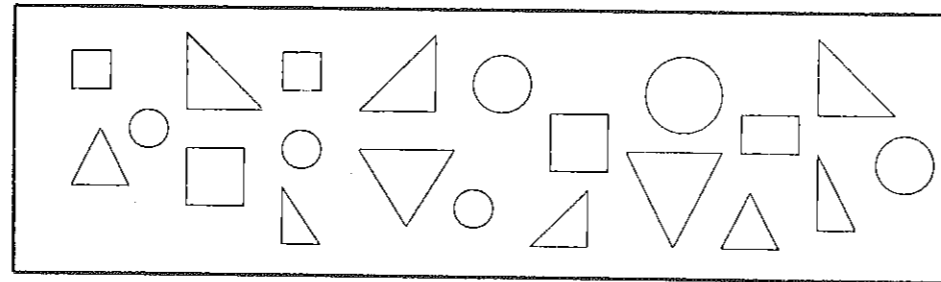

- 3. Gunguli boogey kul dam kali ra (bii follokey ga).
- 4. Kanjehinzey kul koli (bii follokey ga).
- 5. Kaarewey kul dobandi cere ga (bii follokey ga).

6. Kabu-izey biyey tee, ma wey kaŋ ga hima koli.

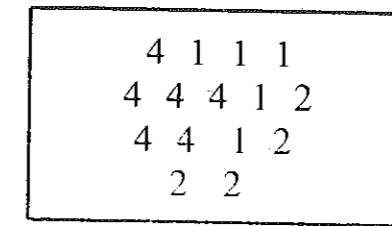

7. Tammaasawey biyey tee, ma wey kaŋ ga hima koli.



8. Biyey wey tee, ma waynaa koli, ma X dam handoo ga.

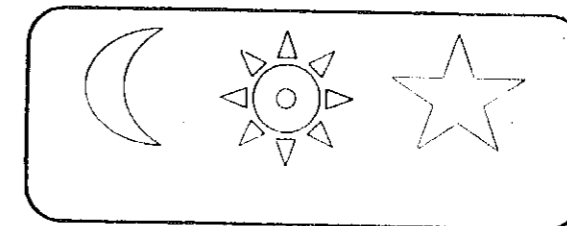

Caw : Suubayan alhaali hinka bande

Taasiha : Taaliboo ma hin :

- ka suubayan tee alhaali hinka bande : taka nda noonay taka nda beeray, beeray nda noonay.

Goyjinawey : Wey kanj goo sunduku sukantaa ra, kaare, kanjehinza, gunguli.

Goyey

Goy jinaa : Alfagaa ma goyjinawey jisi taalibey jine ngi taabaley boŋ. A ma nee taalibey ma goyjinay foo kul takaa har (kaare, kanjehinza, gunguli...), i ma nga noonaa har (boogu, ciray, kara, firzi), i ma nga beeraa har.

Goy hinkantoo : Alfagaa ma nee taalibey ma icirawey margari foo.

Goy hinzantoo : Alfagaa ma nee, taalibey ma goyjinawey birji cere ra, i ma yee k'i suuba alhaali hinka bande : taka nda noonay bande. A ma yee ka nee i ma gunguli cirawey margari foo. I ma yee k'i birji cere ra i ma kaare kaarawey nda kanjehinza firzey suuba.

Goy taacantoo : Alfagaa ma nee taalibey ma goy follokaa tee goyjinawey takaa nda ngi beeraa bande, ngi takaa nda ngi noonaa sanda kanjehinza kaccey ma ti margari foo, goyjinay beeri firzey ma ti margari foo.

Denden

1. Biyey wey tee ma noonay ciray dam ibeerey ga, m'i dobandi.

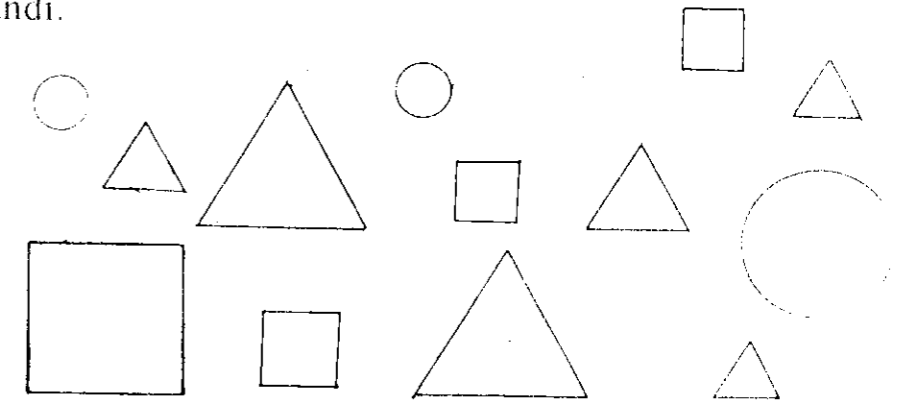

2. Bii follokey tee koyne ma X dam kanjehinza kaccu foo kul ga
3. Bii follokey tee ma boogu dam kanjehinzey ga, m'i koli
4. Biyey wey tee ma gunguley firzandi.

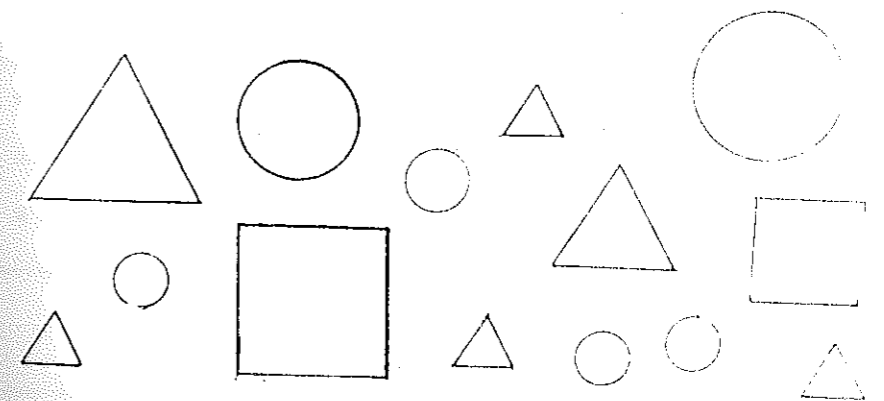

5. Bii follokey tee ma kaarewey karandi.

Caw : Kani-kanandiyan

Taasiha : Taaliboo ma hin :

ka goyjinay suubanteyan kani-kanandi.

Goyey

1. Alfagaa ma jinawey kan goo sunduku sukantaa ra ka taray, a m'i birji. Taalibey ma jinay sii fooyan suub cindey ra alfagaa yaamaroo ga (garbay guley, tondu-izey bundu-izey).
2. Alfagaa ma nee taalibey ma jinawey suuba kan ga hin k koy nda cere, i ma jinay niine* foo kul dam kali ra.
3. Taalibey ma willi goy follokaa ga, jinawey noonaa nda ng beeraa bande.

Denden :

- a. kabu-izey kan ga hima berandi, m'i koli.

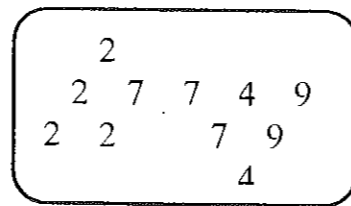

- b. harfey kan ga hima berandi, m'i koli.

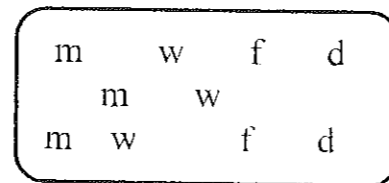

- c. biyey wey tee, ma wey kan ga hima koli.

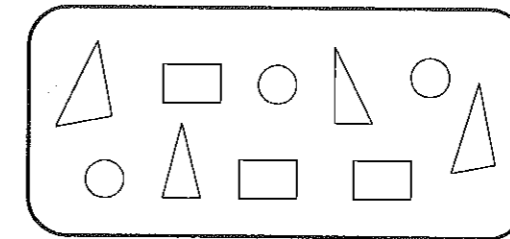

- d. Wey kan ti sii foo kul marga ngi bon se goyjinawey ra kan goo ni jine.
- e. Jinawey ra kan goo ni jine, tondu-ize wargey kul suuba, m'i jisi jere ga.
- f. Ni goyjinawey ra, bundu-ize kukey kul suuba m'i kanandi jere ga.
- g. Biyey wey tee, ma tonbey koli, ma X dam gunguley ga, ma bundu-izey koli.

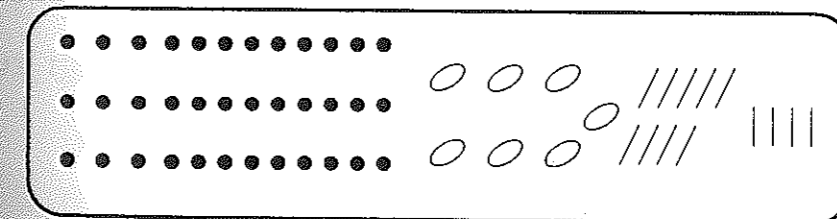

* Niine : dumi, sii.

Filla : Ibaay suubayan nda kani-kanandiyan , Suubayan
 goyjinawey dumey bande Kani-kanandiyan
 Alfagaa ma nee taalibey ma dendeney wey tee.

Denden

Biyey wey tee

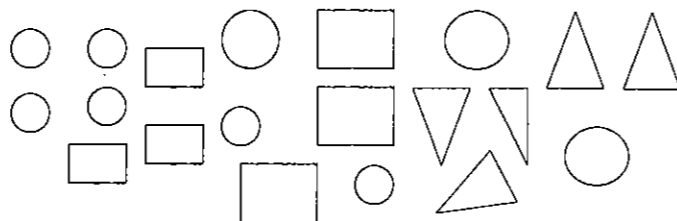

1. Gunguley dobandi.
2. X dam kaarewey kul ga.
3. Iboogu dam kanjehinzey ga.
4. Zeeri hinka dam kaare kaccey cire.
5. Harfey wey biyey tee ma wey kaŋ ga hima dobandi.
 d n ŋ p b d a l o b i c p ŋ
6. X dam ŋ foo kul cire.
7. Biyey wey tee ma X dam ngi kul ibeeroo ga ma ngi kul
 ikaccaa koli.
8. Biyey wey tee ma kanjehinzey firzandi..

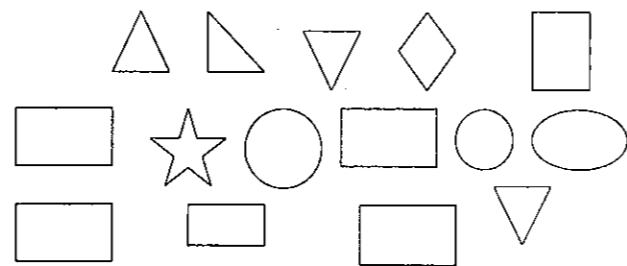

9. Bii follokey ga, muulubiyey koli.

Filla : Ibaay suubayan nda kani-kanandiyan , Suubayan
 goyjinawey dumey bande Kani-kanandiyan
 Alfagaa ma nee taalibey ma dendeney wey tee.

Denden

Biyey wey tee

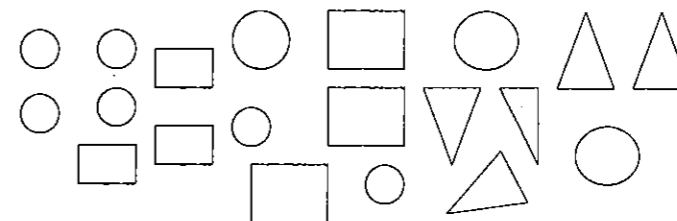

1. Gunguley dobandi.
2. X dam kaarewey kul ga.
3. Iboogu dam kanjehinzey ga.
4. Zeeri hinka dam kaare kaccey cire.
5. Harfey wey biyey tee ma wey kaŋ ga hima dobandi.
 d n ŋ p b d a l o b i c p ŋ
6. X dam ŋ foo kul cire.
7. Biyey wey tee ma X dam ngi kul ibeeroo ga ma ngi kul
 ikaccaa koli.
8. Biyey wey tee ma kanjehinzey firzandi..

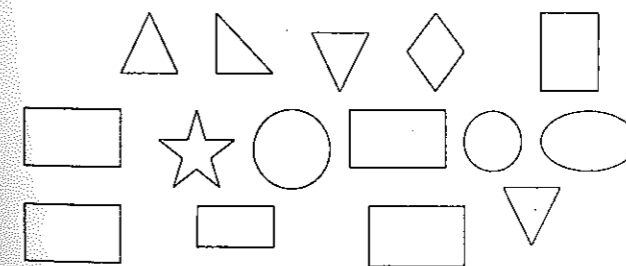

9. Bii follokey ga, muulubiyey koli.

margaroo kaɗ bisa ceroo, nda woo kaɗ kacca nda ceroo.

- Alfagaa ma woo cine boobo tee.

Denden

1. Kanjehinzey hinnaa timmandi hala ngi nda kaarewey hinnaa ma sawa

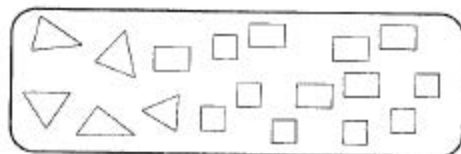

2. Gunguli bibey hinnaa timmandi hala ngi nda gunguli kaarawey ma sawa.

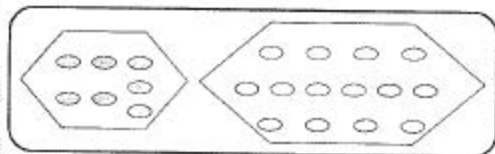

3. X dam margaroo ga kaɗ jinawey hinnaa ga bisa ceroo.

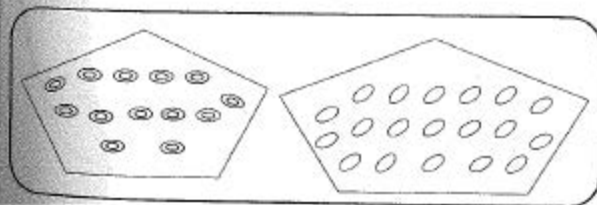

4. X dam margaroo ga kaɗ jinawey hinnaa ga kacca nda ceroo waney.

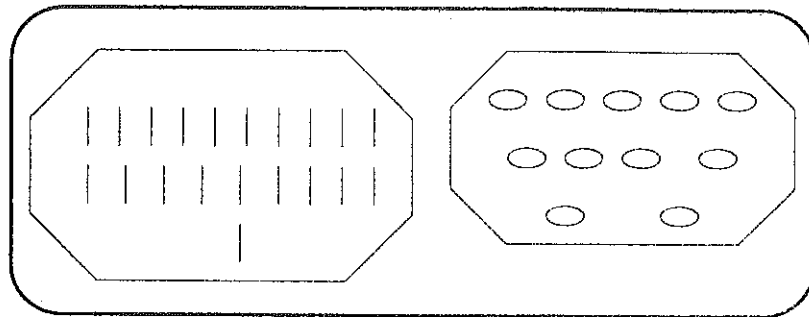

5. Adabba foo kul dobu izoo ga nda haɗaw.

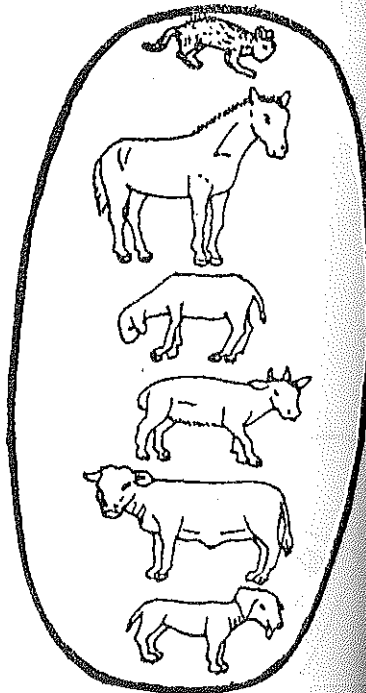
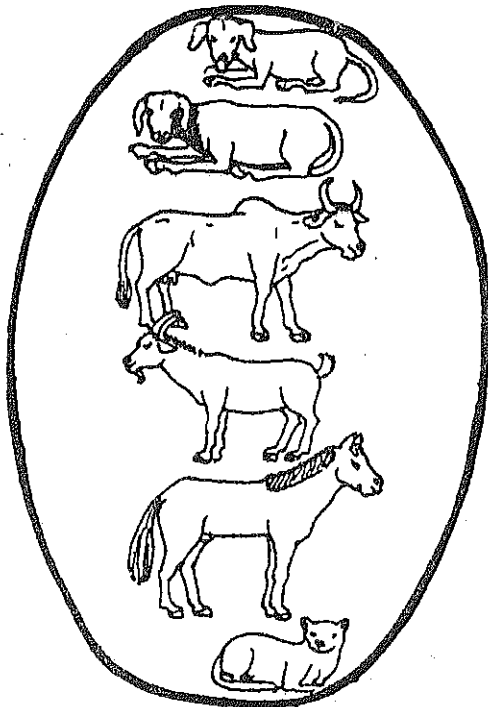

Caw : Suuba-suubayan doona

Taasiha : Taaliboo ma hin :

- ka suuba-suubayan tee ;
- ka hayayaɗ kaɗ suubandi hangandi cere.

Goyjinawey : Taalibi-izey, bundu-izey, teenay guli, garbay guli.

Goyey

Goy jinaa : Taalibey ma banda fur alfagaa se.

- Alfagaa ma kanbey kar cere ga cee hinza a ma kay. Waati banda ga a m'a filla cee boobo.
- Alfagaa ma nee taalibiyaɗ se i ma woo kaɗ se i maa, tee.
- Alfagaa ma nee taalibey kul se i m'a tee.

Goy hinkantoo : Alfagaa ma taalibiyaɗ kayandi :

Woy foo, aru hinka ; woy foo, aru hinka, woy foo, aru hinka.

- Alfagaa ma nee taalibey se i ma goyoo timmandi.

Goy ihinzantoo : Alfagaa ma nee taalibey se i ma bundu-izey nda tondi-izey kanandi ngi taabaley boɗ : bundu-ize foo, tondi-ize foo.

- Taalibey ma goyjinawey barmay, i ma goy follokaa tee.

Denden

1. Goyoo tee, m'a timmandi nda taka kaɗ nda a ga hima.



2. Daaroo tee, m'a timmandi nda taka kaɗ nd'a ga hima.

| | | | | | |
|---|---|---|--|--|--|
| 1 | 1 | 1 | | | |
| 2 | 2 | 2 | | | |
| 3 | 3 | 3 | | | |
| 4 | 4 | 4 | | | |
| 5 | 5 | 5 | | | |

3. Goyoo guna, m'a tee, m'a timmandi.

| | | | | | | | | | | | |
|---|---|---|---|---|---|--|--|--|--|--|--|
| 1 | 2 | 3 | 1 | 2 | 3 | | | | | | |
|---|---|---|---|---|---|--|--|--|--|--|--|

4. Goyoo guna, m'a tee, m'a timmandi.

| | | | | | | | | | | | | | |
|---|---|---|---|---|---|---|---|--|--|--|--|--|--|
| 4 | 3 | 2 | 1 | 4 | 3 | 2 | 1 | | | | | | |
|---|---|---|---|---|---|---|---|--|--|--|--|--|--|

5. Goyoo tee, ma sorraa timmandi.

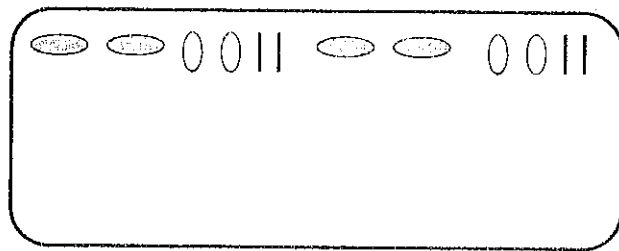

6. Goyoo tee, ma sorraa timmandi.

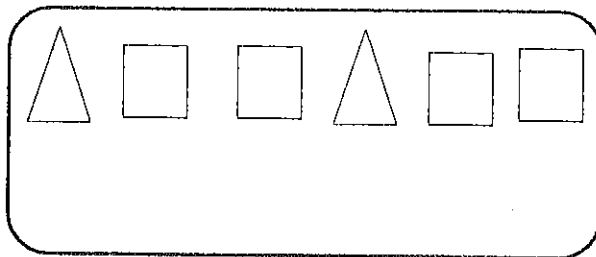

7. Goyoo tee m'a timmandi.

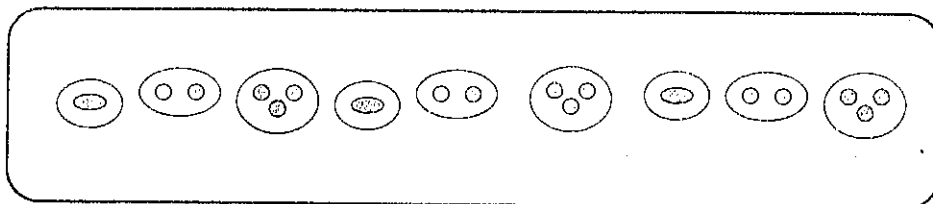

Caw : Hanga-hangandiyar

Taasiha : Taaliboo ma hin :

- ka jinayyan hanga-hangandi alhaali foo bande.

Goyjinawey : Taalibi-izey, bundu-izeyan kaɗ kuuyaney ga bisa cere, walhawey.

Goyey

Goy jinaa : Alfagaa ma taalibi iyye kaɗ ga bisa cere kayyan cee ngi cerey jine.

- Alfagaa ma nee taalibey ma bora suuba kaɗ kuu nda i kul ; a ma yee jere ga.

Takaa woo da hala iyyaa kul ma ben ; i ma kay-kay cere bande.

- Alfagaa ma nee taalibey ma willi ka goro. A ma affooyan cee koyne.

- Alfagaa ma nee cerey se i ma bora suuba kaɗ duura nd'i kul. Takaa woo da, hal'i ma ben i ma kay-kay cere bande.

Goy hinkantoo : Alfagaa ma nee taalibey ma bundu-ize guu kaɗ kuuyaney si sawa kanandi nga jine.

A ma nee zankey m'i hanga-hangandi cere bande ka hun iduura ga ka koy ikuukoo ga nda taka kaɗ nd'i bisa cere.

- Alfagaa ma nee i ma goyoo kaɗ i n'a tee, biyoo tee.

Alfagaa ma taalibiyar cee i ma ngi goyoo tee walhabeeroo ga sanda :

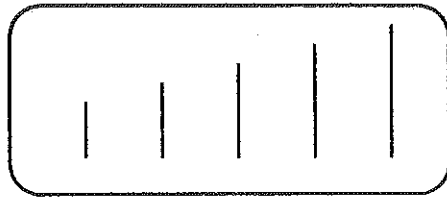

Duurandi : hanga-hangandiyan ti ka margari foo jinawey hangandi cere bande ; boro g'i deedandi ihinka-hinka ngi alhaaley bande wala fondo tana bande.

Denden

Zeerey gorandi taka kañ nd'i ga hun i kul iduura ga ka koy ikukoo ga.

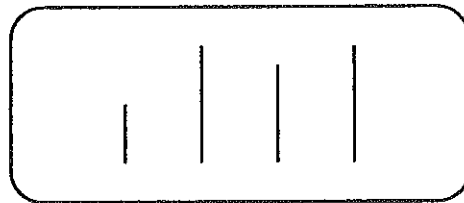

1. Yee ka zeeri follokey gorandi ka hun ibeeroo ga ka koy ikacaa ga.
2. Tondi-izey kañ goo ni jine hanga-hangandi cere bande ka hun i kul ikacaa ga ka koy ibeeroo ga.
3. Tondi-izey kañ goo ni jine hanga-hangandi cere bande ka hun i kul ibeeroo ga ka koy ikacaa ga.
4. Bundu-izey kañ goo ni jine hanga-hangandi cere bande ka hun i kul ikacaa ga ka koy ibeeroo ga.
5. Bundu-izey kañ goo ni jine hanga-hangandi cere bande ka hun i kul ibeeroo ga ka koy ikacaa ga.
6. Bundu-izey kañ goo ni jine hanga-hangandi cere bande ka hun i kul ibeeroo ga ka koy ikacaa ga.

Filla : Tenjandiyan, suubu-suubayan doona, hanga-hangandiyan

Alfagaa ma nee taalibey ma dendeney wey tee.

Denden

1. Biyey wey tee, ma sokol foo tenjandi nda taasa foo.
2. Biyey wey tee ma kanjehinza foo nda gunguli foo kul dobandi.

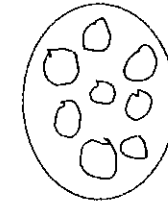

3. Gunguley biyey tee, m'i tenjandi ibeeri foo nd'ikaccu foo. Ngi hinnawey ga sawa wala? Wey har kañ hinnaa ga boobo nda cerey.
4. Biyey wey tee, ma fuula foo kul nda boro foo tenjandi.
5. Biyey wey tee, ma hamiisa hinka kanandi ma delbu foo hangandi a bande.
6. Daaroo woo tee m'a timmandi nda taka kañ nda a ga hima.

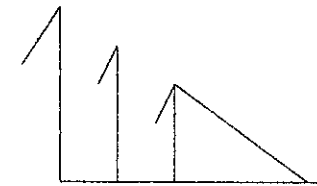

7. Daaroo woo biyoo tee, m'a timmandi nda taka kaj nd'a ga hima.

| | | | | | | | | |
|-------|-------|-------|--|--|--|--|--|--|
| ○ ○ . | ○ ○ . | ○ ○ . | | | | | | |
|-------|-------|-------|--|--|--|--|--|--|

8. Biyey wey tee, m'i hanga-hangandi cere ka hun iduura ga ka koy ikukoo ga.

9. Zeerey wey tee m'i hanga-hangandi cere bande ka hun ikukoo ga ka koy iduura ga.



10. Tuuri foo kul dobu izoo ga nda hanaw.

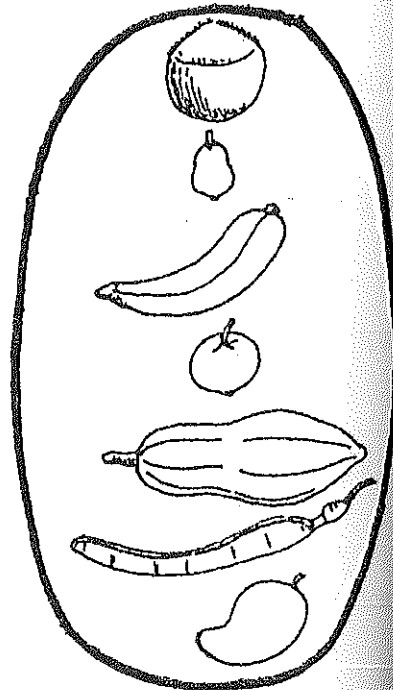
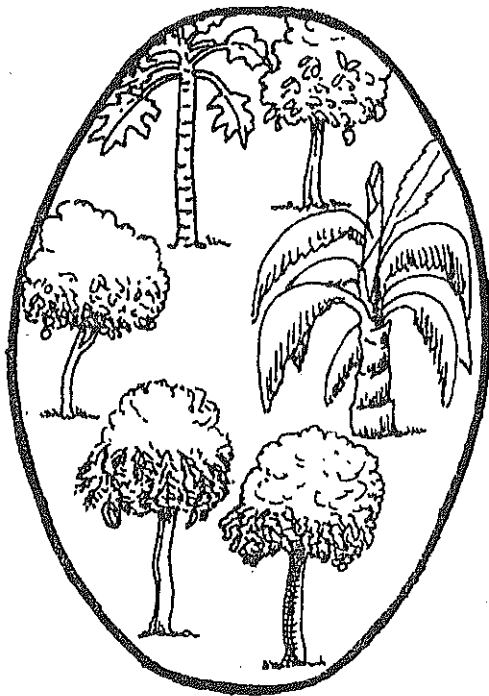

HINNABAYRAY

Caw : 1 ka koy 9 hinnawey

Taasiha : Taaliboo ma hin :

- ka haya margantey kaɗ hinnawey ga sawa hangandi cere bande ;
- ka hayey kaɗ goo margari ra hinnaa bay ;
- ka hinnawey 1 ka koy 9 caw, a m'i hantum nda kabu-ize nda harfu ;
- ka kabu 1 ka koy 9 ;
- ka margari tee kaɗ hayey kaɗ goo a ra hinnaa ga bayrandi.

Goyjinawey : tondi-ize, batayaɗ, bundu-ize, bonbonyaɗ, teenayyaɗ.

Goyey

1. Alfagaa ma nee taalibi foo kul ma kate margari guu kaɗ ra haya 1,2,3,4,5 goo.
 - Alfagaa ma taalibey fay-fay k'i tee kurayyaɗ.
 - Alfagaa ma nee kuray foo kul se a ma margariyaɗ tee nda hayey; i ma addaliloo har kaɗ se i n'i dam cere ga. Nda taalibiyaɗ tee kaɗ na goyoo tee nda fonda, alfagaa ma nee cindey se i m'i zente. Nda kuray kul mana goyoo tee ka boori, alfagaa nda taalibey m'a tee nda cere.
 - Alfagaa m'a hantum walhabeeroo ga, a ma wiri taalibey ga, i m'a caw, i m'a hantum.

2. Alfagaa ma margarey wey biyey tee walhabeeroo ga. A ma nee taalibey se, i m'i tee jina, i ma margarey kaŋ ra hinna follokaa goo dobu cere ga nda zeeri.

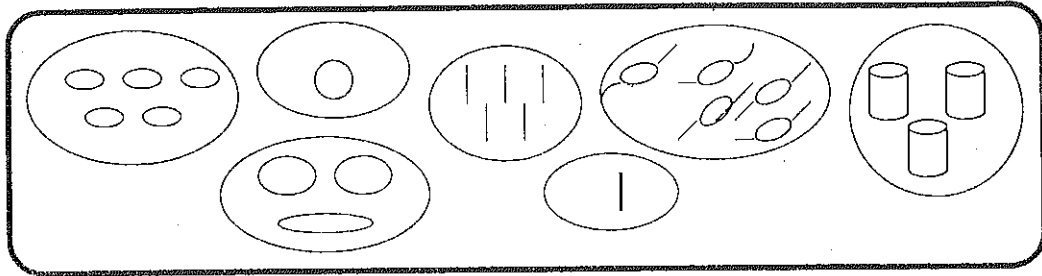

3. 1 bayraa :

- Alfagaa ma nee kuray foo kul se, a ma jinawey wey dam cere ga, jina, a ma margarey kaŋ ra hinna foo goo dam cere here.
- 4. Alfagaa ma margari booboyaŋ biyey tee walhabeeroo ga kaŋ ra margari hinzaa goo kaŋ mo goo nda haya folloku.

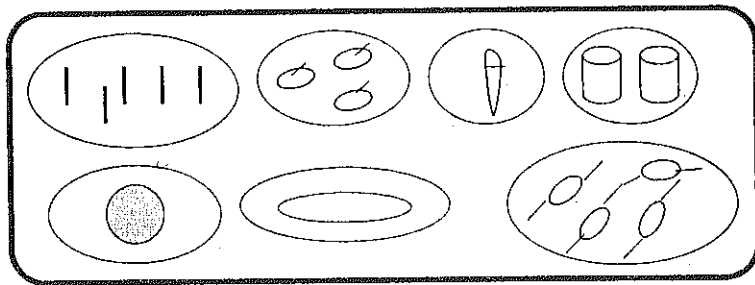

- Alfagaa ma nee taalibey se i ma biyey wey tee jina, i ma wey kaŋ ra haya folloku goo dobu cere ga nda zeeri.
- Alfagaa ma wiri, taalibi foo-fooyaŋ ma nee margari hinzaa woo, affoo kul haya foo bar'a ra. Woo din banda ga a ma nee taalibey ma affoo har «1» cee booboyaŋ.

Denden

1. Alfagaa ma zeeri serrante foo tee walhabeeroo ga, a ma 1 hantum zeeroo boŋ. A ma nee taalibey m'a hantum cee booboyaŋ.
2. Margarey berandi, ma X dam wey kaŋ goo nda haya folloku, cire.

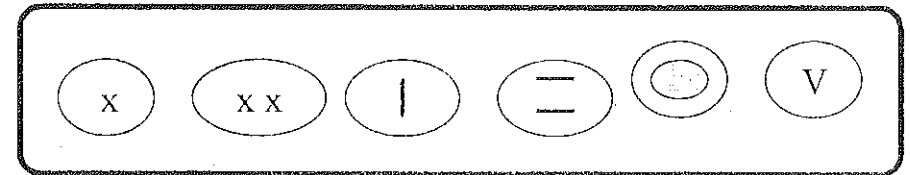

3. Denden follokaa no kaŋ tee ihinkantoo ra, amma woo ra taalibey ma margarey kaŋ ra haya folloku goo dobu cere ga nda zeeri
4. Margarey kaŋ ra haya folloku goo tee m'i dobu ga.

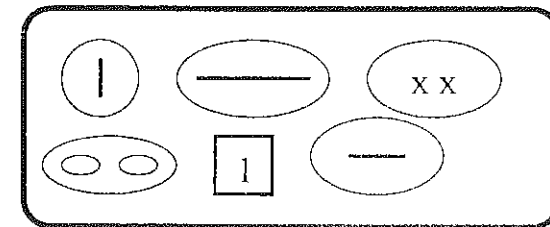

5. Hinnawey bayraa : 4,2,5,3 cawandoo nda 1 wanoo kul ga tee nda taka follokaa.

6. 6 Bayraa :

- Alfagaa ma nee taalibey ma kabu 1 ka koy 6 ga. A ma nee taalibey ma margariyaŋ biyey tee kaŋ ra haya 6 goo.
- Alfagaa ma margari bii tee walhabeeroo ga kaŋ ra haya 6 goo.
- A ma nee 6 ; taalibey m'a har a bande cee booboyaŋ.
- A ma 6 hantum, a m'a cawandi taalibey se.
- Woo din banda ga taalibey m'a hantum.

Denden

1. Alfagaa ma zeeri serrante foo tee walhabeeroo ga, a ma 6 hantum zeeroo boŋ. A ma nee taalibey m'a hantum cee booboyaŋ sanda takaa kaŋ nda 1 cawandoo tee.
2. Margarey wey biyey tee, jina ma koli dam margarey ga kaŋ ra haya iddu goo

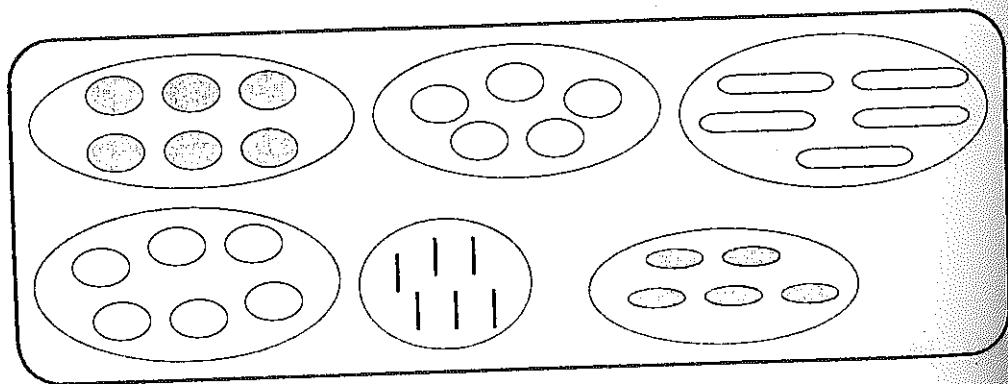

3. Bii follokey tee koyne, ma wey kaŋ ra haya iddu goo dobandi tammaasaa woo 6 ga, nda zeeri.
4. Hinnawey, 1 ka koy 6, hantum nda kabu-ize nda harfu.

7. 7 bayraa :

Taka follokaa kaŋ nda alfagaa na 6 cawandi, a m'a ka 7 cawandi (cawandoo nda dendeney).

8. 8 nda 9 bayraa :

Taka follokaa kaŋ nda alfagaa na 6 nda 7 cawandi m'a ka 8 nda 9 cawandi (cawandoo nda dendeney).

Denden

- 1 - 1 ka koy 9 hantum nda kabu-ize nda harfu.
- 2 - Wey tee m'i timmandi.

| | |
|---|-------|
| 1 | _____ |
| 2 | _____ |
| 3 | _____ |
| 4 | _____ |
| 5 | _____ |
| 6 | _____ |
| 7 | _____ |
| 8 | _____ |
| 9 | _____ |

- 3 - Wey berandi ma hayey biyey tee hinnawey cire.

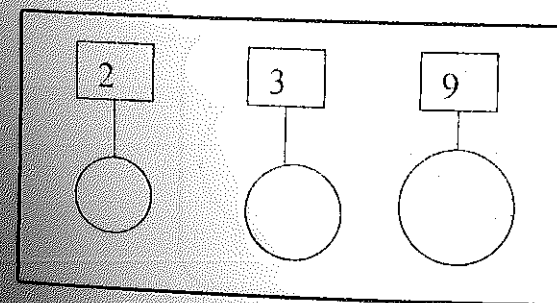

4 – Margarey wey biyey tee ma jinawey hinnaa dam i ra.

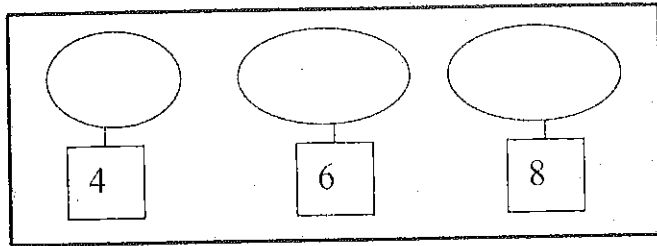

5 – Margaroo woo biyoo tee jina, ma haya 5 marga cere ga nda koli.

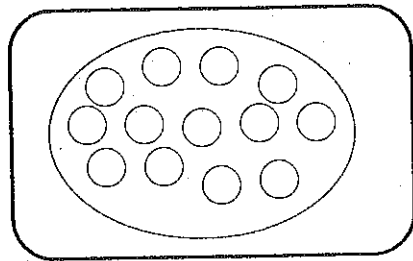

6. Margaroo woo biyoo tee jina ma harfu dumi foo kul hinnaa hantum.

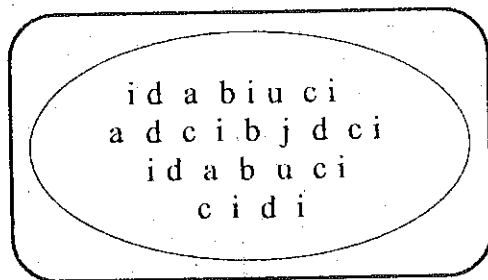

7. Biyey wey tee, ma margari foo kul margari-izey hinnaa hantum hugu-izoo ra kanj goo a cire.

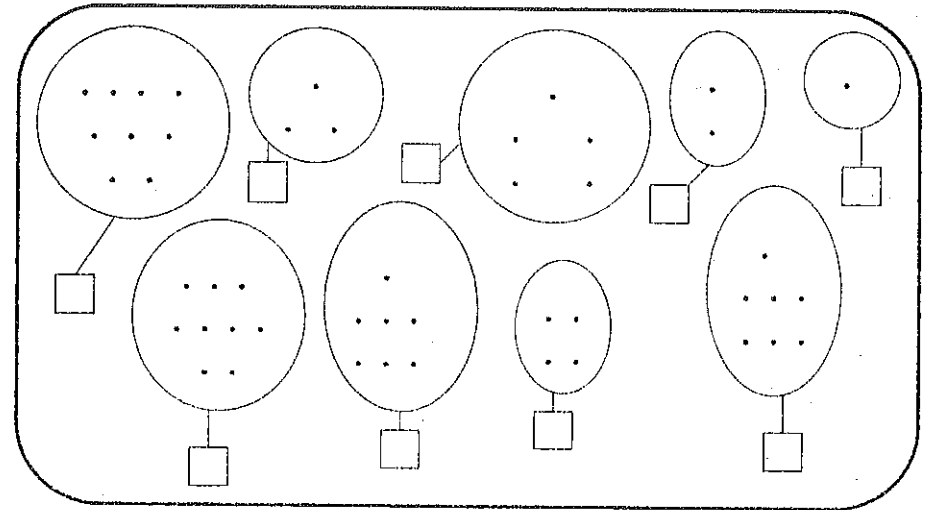

8. Daaroo woo tee, ma kalimapaŋoo woo hantum nda kabu-ize kanj goo harfey boŋ sorro foo kul ra sanda

Ay → 1 ; 7

Ay ga hansa ka waani hantumyan nda kabuyan.

| | | | | | | | | |
|---|---|---|---|---|---|---|---|---|
| 1 | 2 | 3 | 4 | 5 | 6 | 7 | 8 | 9 |
| a | b | c | d | e | f | g | h | i |
| j | k | l | m | n | ŋ | ŋ | o | p |
| r | s | š | t | u | w | y | z | z |

Caw : 1 ka koy 9 hinnawey hanga-hangandiyaa cere bande

Taasiha : Taaliboo ma hin :

- ka margari-izeyaŋ kaŋ goo margari hinka ra hinnawey deedandi a ma bay woo kaŋ ga kacca nda ceroo ($<$) nda woo kaŋ ga bisa ceroo ($>$) nda wey kaŋ ga sawa nda cere ($=$) ;
- ka 1 ka koy 9 hinnawey hanga-hangandi cere bande k'i har 1 ka koy 9 wala 9 ka kaa 1.

Goyjinawey : Taalibey, margari booboyaŋ kaŋ ra 1 ka koy 9 hinnawey margari-ize goo.

Goyey

Goy jinaa : Alfagga ma margariyaŋ tee kaŋ ra taalibi 2, 3, 4, 5, 6, 7, 8, 9 goo, a m'i sasawandi nda 2-2 ka duu ka bay margaroo kaŋ taalibey hinnaa bise margarey kul, woo kaŋ nga waney hinnaa bisa margarey kul, woo kaŋ waney hinnaa kacca nda i kul nda wey kaŋ hinnawey ga sawa.

Goy hinkantoo : Alfagaa ma taalibey fay k'i tee kurayyaŋ.

I ma yee ka goy jinaa tee nda margariyaŋ kaŋ ra margari-ize 1 ka koy 9 goo.

Goy hinzantoo : Alfagaa ma nee kuray foo kul ma margari hinka sanbu. Ijinaa margari-ize hinka ma bara a ra, ihinkatoo margari-ize 3 ma bara a ra.

Taalibey ma margari hinkaa sasawandi. I ma nee 2 ga kacca nda 3, taalibi booboyaŋ ma yee k'a har.

Goy taacantoo : Alfagaa ma nee kuray foo kul ma margari hinka biyey tee ngi wallhawey ga. Ijinaa margari-ize 2 ma bara a ra, ihinkatoo margari-ize 3 ma bara a ra. Taalibey ma hinna hinkaa sasawandi nda « ga kacca nda » ($<$). Alfagaa ma woo hantum : $2 < 3$ a ma nee « 2 go kacca nda 3 ».

Taalibey m'a har cee booboyaŋ i m'a hantum.

Alfagaa ma nee kuray foo kul ma himakasine foo tee kaŋ ga hima nda woo kaŋ i n'a tee.

Denden

1. Kabu-izey sasawandi nda tammaasaa woo $<$: 6 nda 8 ; 5 nda 9 ; 3 nda 7.
2. Wey berandi m'i timmandi nda tammaasaa woo $<$:
2 ... 4 ; 2 ... 9 ; 5 ... 8 ; 3 ... 6 ; 7 ... 9

Goy guwantoo : Alfagaa ma yee goy hinzantoo nda itaacantoo ga k'i tee nda tammaasaa woo « $>$ ».

Denden 1 : Alfagaa ma nee kuray foo kul ma himakasine foo ceeci kaŋ ra « $>$ » goo.

Denden 2 : Kabu-izey sasawandi nda tammaasaa woo « $>$ » : 3 nda 7 ; 4 nda 2 ; 5 nda 1.

Denden 3 : Kabu-izey wey hantum m'i timmandi nda tammaasaa woo « $>$ » :

2 ... 1 ; 5 ... 2 ; 8 ... 4 ; 9 ... 3.

Goy idduwantoo : Alfagaa ma nee kuray foo kul ma margari hinka : A nda B biyey tee kaḅ hinnawey kaḅ goo i ra ga sawa. A ma nee, i ma margari hinkaa sasawandi. Alfagaa ma nee hinna follokaa bara margarey kul ra.

Alfagaa ma hantum $7=7$ a m'a caw 7 ga sawa nda 7. A ma nee taalibey m'a har, i m'a hantum.

Denden

- Margariyaḅ tee kaḅ margar-izey kaḅ goo i ra hinnaa ga sawa, m'i sasawandi nda tammaasaa woo : « = ».
- Hinnawey hantum m'i timmandi nda tammaasawey wey : $>$; $<$; $=$.
5 ... 5 ; 7 ... 4 ; 5 ... 6 ; 9 ... 9 ; 1 ... 2 ; 3 ... 4.
- 1 ka koy 9 hinnawey durse.
- 9 ka koy 6 hinnawey durse.
- Biyey wey berandi, m'i timmandi.

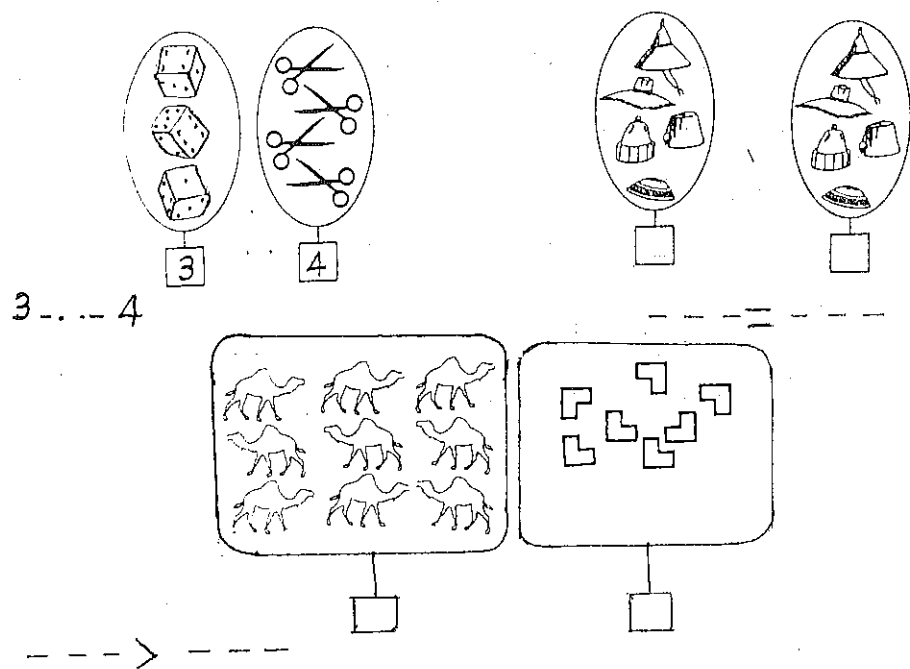

6. Hinnawey wey berandi, ma tammaasawey wey ($>$, $<$, $=$) dam nongey kaḅ ra i ga hima ka huru.

2 ... 3 3 ... 5 4 ... 4 9 ... 7

1 ... 2 3 ... 2 8 ... 8 9 ... 5

4 ... 3 1 ... 4 7 ... 7 5 ... 5

7. Hinnawey hantum kaḅ ga hin ka huru.

... $<$... ; ... $>$... ; ... $<$... ; ... $>$... ;

... $=$... ; ... $=$...

8. Biyey wey tee, ma hinnawey hantum hugu-izey kaḅ goo i cire ra jina, ma margarey dobandi cere ga nda kaḅaw ka sintin hinna kaccey ga ka koy ibeerey ga.

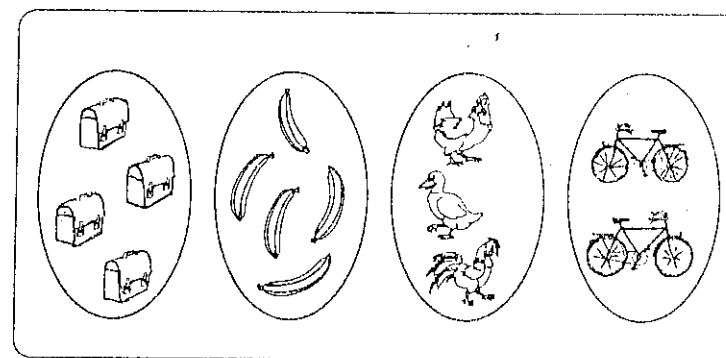

9. Biyey wey tee, ma hinnawey hantum hugu-izey kaḅ goo i cire ra jina, ma margarey dobandi cere ga nda kaḅaw ka sintin hinna ibeerey ga ka koy kaccey ga.

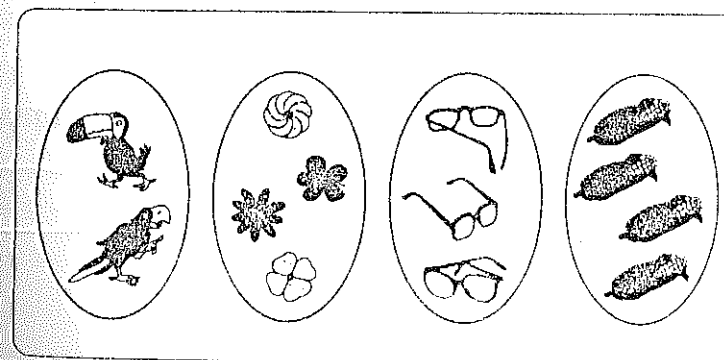

Caw :: 1 ka koy 9 hinnawey fesu-fesuyanoo

Taasiha : Taaliboo ma hin :

- ka margari foo zamni k'a tee margari-izeyan kan ra hayayan goo kan sii cere ga ;
- ka goy nda tammaasawey wey : + nda = waati kan a ga hinna fesu-fesu ;
- ka hinna foo fesu-fesu nda hinna hinka, a m'a durse.

Goyjinawey : Tondi-ize, bundu-ize, nooru-ize.

Goyey

Goy jinaa : Alfagaa ma nee taalibi foo kul ma kate jinay 9.

- A ma taalibey fay-fay k'i tee kurayyan.
- Kuray foo kul ma margari foo tee kan ra haya hinka goo.
- Alfagaa ma nee taalibey ma margarey fersi.
- A ma kate taalibey ma nee kan margaroo, margari-ize hinka bar'a ra.
- Alfagaa ma hantum : $2 = 1 + 1$
- Alfagaa ma zankey yaamar i m'a hantum.

Goy hinkantoo : Alfagaa ma nee kuray foo kul ma margari foo tee kan margari-izey masi bisa 9, i ma margari fersariyan tee nda margaroo izey. Kuray foo kul ma filla taka kan nd'a na goyoo tee.

- Alfagaa ma nee kuray foo kul ma margari jinaa izey hinnaa hantum nda hinnawey kan goo fersarey ra.

- Alfagaa ma fondawey kan bangay cawhugoo ra kul tee. Woo maanaa ti a ma kuray foo kul hinnaa kan a duu a fesu-fesu nda hinna hinka sanda :

$$\begin{aligned}
 3 &= 1 + 2 ; & 3 &= 2 + 1 \\
 4 &= 1 + 3 ; & 4 &= 2 + 2 \\
 5 &= 3 + 2 ; & 5 &= 1 + 4 \\
 6 &= 3 + 3 ; & 6 &= 2 + 4 ; & 6 &= 1 + 5 \\
 7 &= 6 + 1 ; & 7 &= 3 + 4 ; & 7 &= 5 + 2 \\
 8 &= 4 + 4 ; & 8 &= 7 + 1 ; & 8 &= 6 + 2 ; & 8 &= 3 + 5 \\
 9 &= 5 + 4 ; & 9 &= 6 + 3 ; & 9 &= 7 + 2 ; & 9 &= 1 + 8.
 \end{aligned}$$

Goy hinzantoo : Daaroo woo berandi, m'a timmandi.

| 2 | 3 | 4 | 5 | 6 | 7 | 8 | 9 |
|---------|---------|---------|---------|---------|---------|---------|---------|
| ---+--- | ---+--- | ---+--- | ---+--- | ---+--- | ---+--- | | |
| | | ---+--- | ---+--- | ---+--- | ---+--- | ---+--- | ---+--- |
| | | | | ---+--- | ---+--- | ---+--- | ---+--- |
| | | | | | | ---+--- | ---+--- |
| | | | | | | ---+--- | ---+--- |
| | | | | | | | ---+--- |

Denden

1. Biyey wey tee jina m'i timmandi.

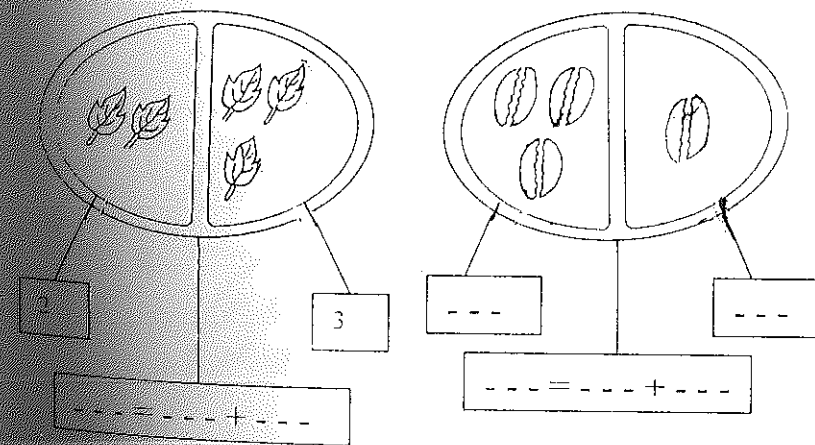

2. Margarey wey tee, m'i timmandi.

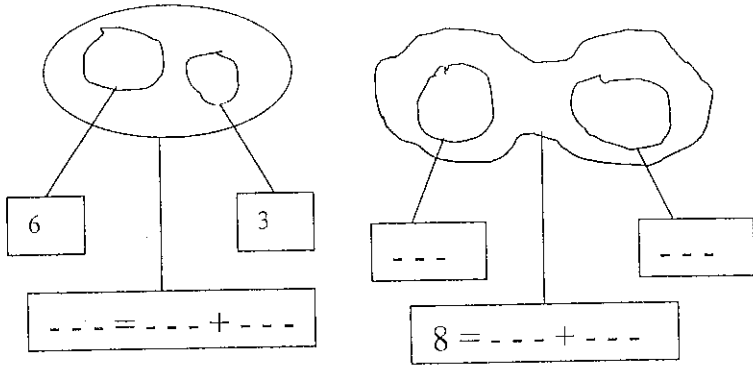

3. Margari foo kul fay k'a tee ihinka, ma kabey timmandi.

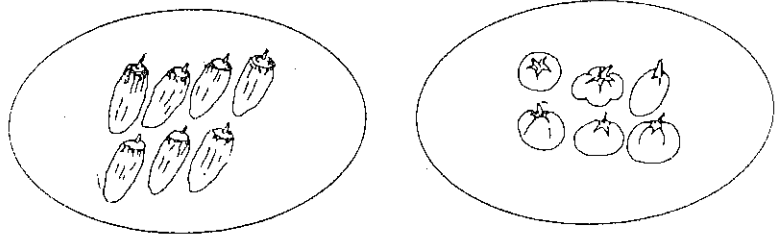

$7 = \text{---} + \text{---}$

$6 = \text{---} + \text{---}$

4. Margarey biyey tee ma affoo kul fay k'a tee ihinza ma kabey timmandi.

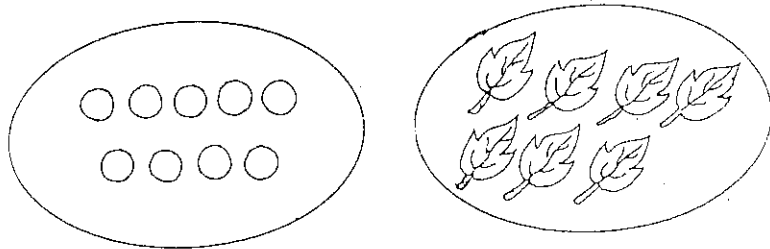

$9 = \text{---} + \text{---} + \text{---}$

$7 = \text{---} + \text{---} + \text{---}$

5. Woo tee m'a timmandi.

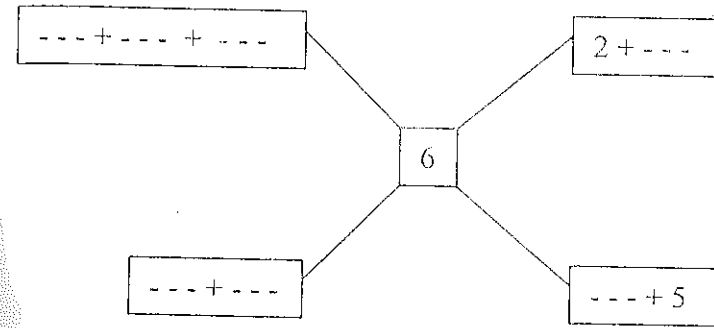

6. Daaroo tee ma hinnawey kaŋ ga sawa nda 4 cirandi, ma wey kaŋ ga sawa nda 3 karandi.

| | | |
|---------|---------|---------|
| $1 + 4$ | $2 + 1$ | 3 |
| $2 + 2$ | $3 + 2$ | $1 + 3$ |
| $1 + 2$ | $4 + 2$ | $1 + 1$ |
| 4 | $1 + 1$ | $3 + 1$ |

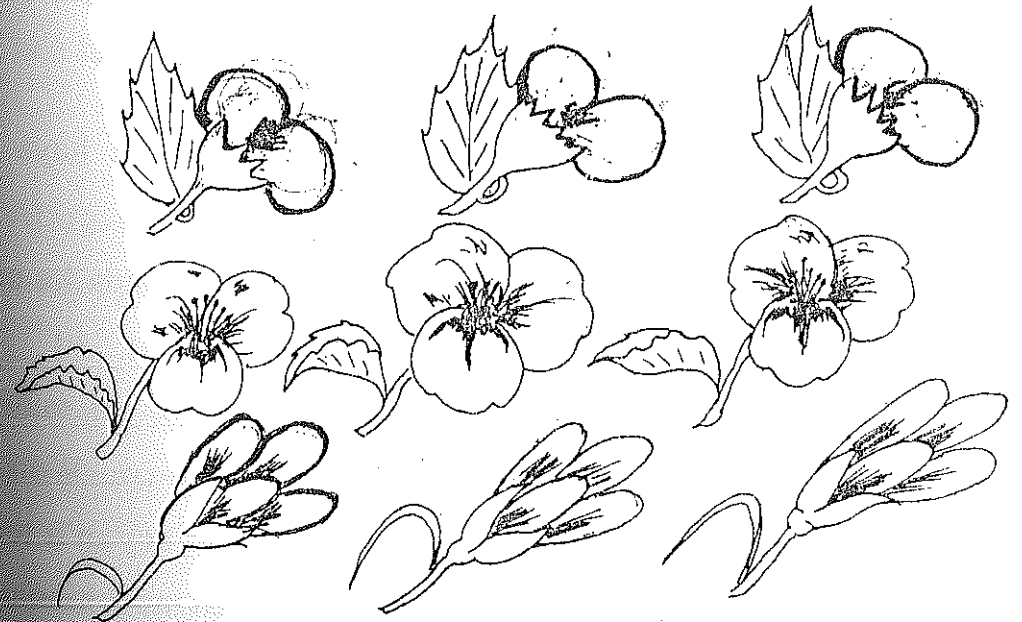

Caw : 0 nda 10 hinnawey

Taasiha : Taaliboo ma hin :

- ka margari-izey hinnaa kaŋ goo margari ra bay ;
- ka 0 ka koy 10 hinnawey caw k'i hantum nda kabu-ize nda harfu ;
- ka margari tee kaŋ margari-izey kaŋ goo a ra hinnaa ga bayrandi ;
- ka hinna fesu-fesu wala k'a cin ;
- ka hinnawey hanga-hangandi cere bande hala 10.

Goyjinawey : Tondi-ize, bundu-ize, taalibiyay, teenayyan.

Goyey

Goy jinaa : Alfagaa ma nee taalibey ma kurayyan tee kaŋ ga ti boro hinka-hinka. Kuray foo kul ra boro foo kon goyjinawey goo kaŋ a g'i noo ceroo se nda affoo-foo hala ma ben.

- Alfagaa ma hãa wala jinay cindi a kone.
- Alfagaa ma taka tee kaŋ nda taalibey ma nee haya ku mana cindi nookaa kone.
- Alfagaa ma nee haya kul sii taaliboo kone , yaada ka cin a se.
- Alfagaa ma yaada (0) hantum walhabeeroo ga; taalibey m'a caw cee boobo, i m'a hantum nda kabu-ize. Woy banda ga, alfagaa m'a hantum nda harfu taalibey m'a tee Taalibey ma laasaabu kaŋ yaada ka kacca nda hinnawey kul kaŋ i n'i caw.

Denden

1. Alfagaa ma misayan har kaŋ ra misawey zaabey ga ti yaada.
2. 0 hantum ka koy sanda :
0 0 0
3. Hinnawey hantum, m'i hanga-hangandi cere bande.
9 ; 7 ; 2 ; 4 ; 0 ; 5 ; 8 ; 3 ; 6 ; 1.

Goy hinkantoo : Alfagaa ma kurayyan tee, a ma affoo kul noo margari kaŋ ra margari-ize woy goo, a ma nee i m'i kabu.

- Alfagaa ma nee taalibey ma margari bii tee kaŋ ra margari-ize woy goo.
- Alfagaa m'a tee walhabeeroo ga.
- Alfagaa ma iwoy hantum nda kabu-ize walhabeeroo ga; a ma nee taalibey m'a caw, i m'a hantum ngi walhawey ga.
- Alfagaa ma iwoy hantum nda harfu walhabeeroo ga, a ma nee taalibey m'a caw, i m'a hantum.

Denden

1. Alfagaa ma iwoy hantum walhabeeroo ga, a ma nee taalibey m'i berandi, i ma hantum ka koy.
10 10 10 - - -
2. Hinnawey wey hantum harfu ra : 0 ; 4 ; 2 ; 3 ; 7 ; 8 ; 9 ; 10.
3. Hinnawey wey hantum, m'i hanga-hangandi cere bande :
0 ; 1 ; 3 ; 4 ; 5 ; 6 ; 7 ; 8 ; 9 ; 10 ; 2.
4. Hinnawey 0 ka koy 10 hanga-hangandi cere bande.

Denden

1. Biyey tee, ma tammaasaa woo X dam margarey cire kan ra margari-ize 10 goo.

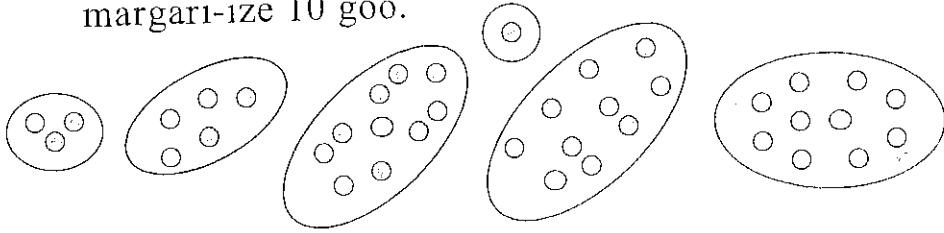

2. Biyey tee, ma margari fersarey kan ra margari-ize 10 goo dobandi cere ga nda zeeri.

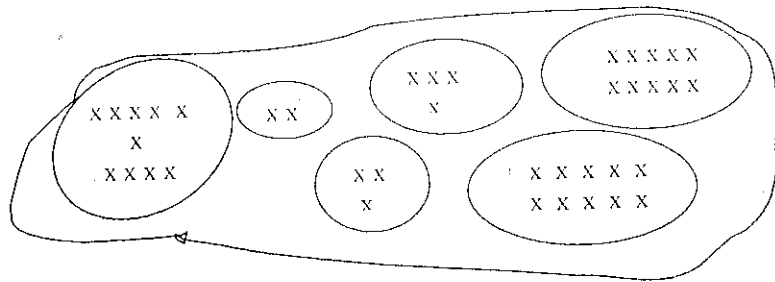

3. Zeeri boobo tee gunguli ra, ma 10 margari hinnaa kan goo a ra koli.

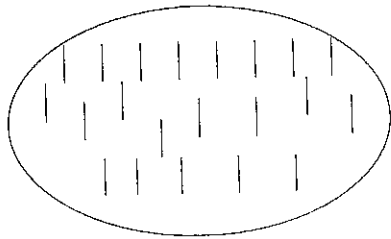

4. Sawandoo woo timmandi, ma nga margarey tee.

$$10 = \text{---} + \text{---}$$

5. Biyoo woo tee, ma margaroo fay k'a tee ihinza, ma sawandoo hantum.

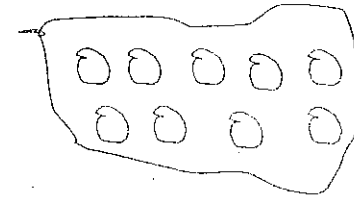

6. Biyey tee, ma margari-izey hinnaa tee gundey ra.

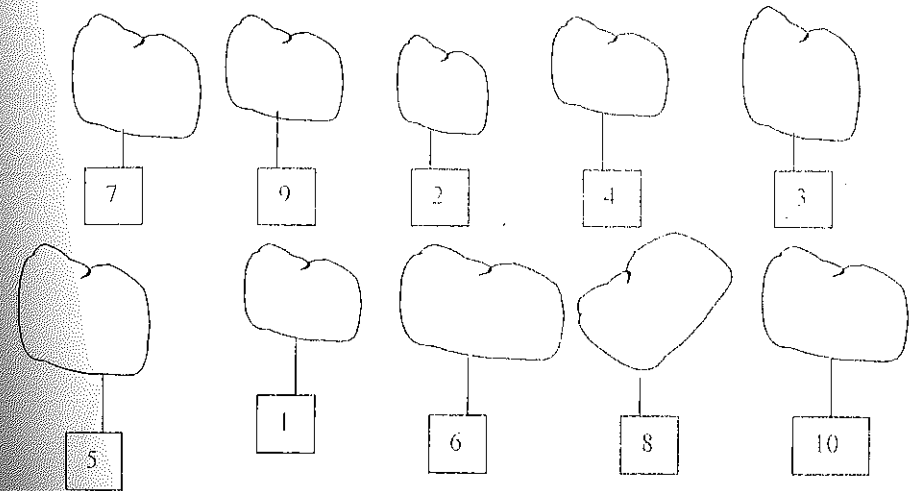

7. 10 dobandi nga fesu-fesuyaney wey ga nda zeeri.

| | | |
|-------|-------|-------|
| $8+5$ | $9+1$ | $8+2$ |
| $3+2$ | 10 | $4+2$ |
| | $7+3$ | |

8. Biyey tee, ma hinnaa hantum hugu-izoo ra kan goo a cire.

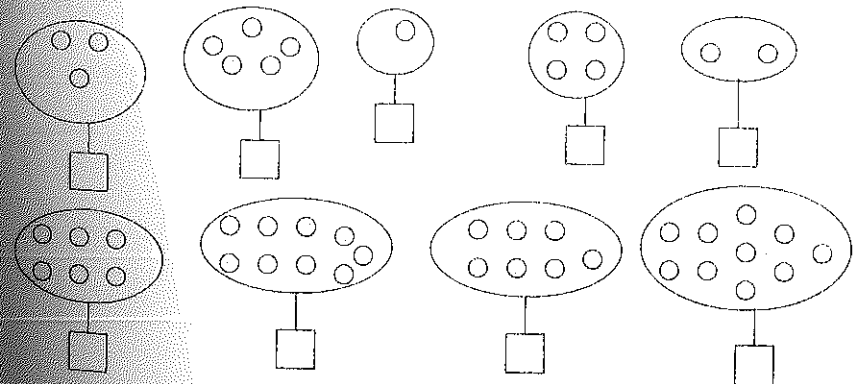

9. Hinnawey dobandi cere ga nda haɗaw ka sintin nda i kul ibeeroo ka koy i kul ikacceaa ga.

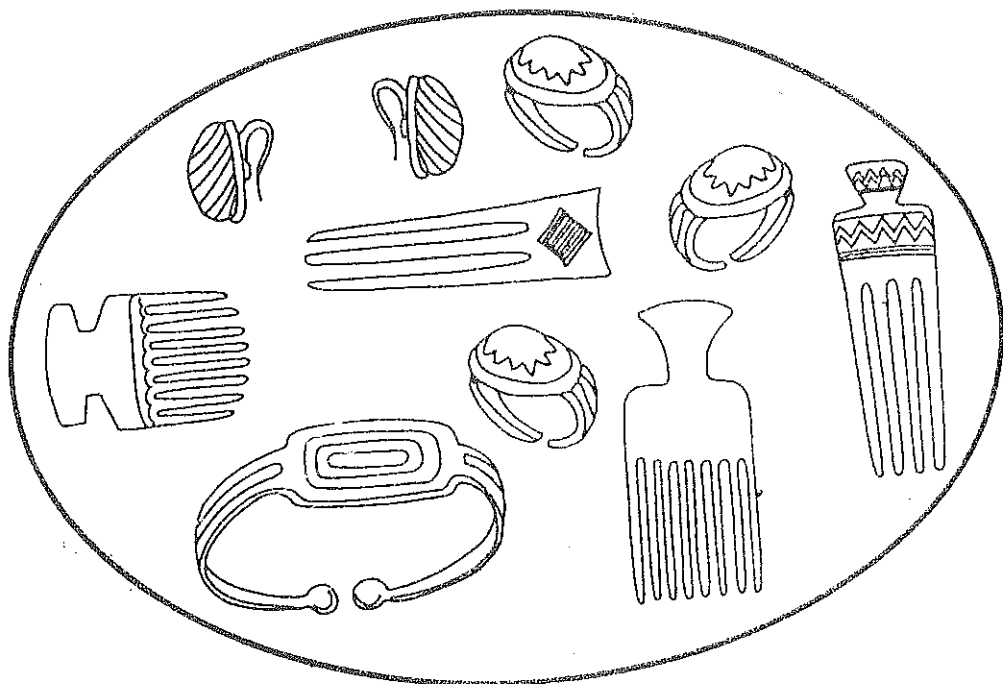
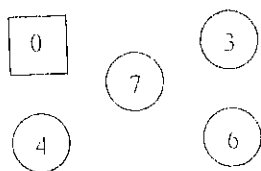

Caw : 0 ka koy 10 hinnawey

Taasiha : Taaliboo ma hin :

- ka margari-izey hinnaa kaɗ goo margari ra, bay ;
- ka 0 ka koy 10 hinnawey cin, a m'i caw, a m'i hantum nda kabu-ize nda harfu ;
- ka 0 ka koy 10 hinnawey hanga-hangandi cere, k'i fesu-fesu.

Goyjinawey : bundu-ize, tondu-ize, teenayyaɗ, hkh.

Goyey : Alfagaa ma nee taalibey ma dendeney wey tee.

Denden

1. Biyey tee, ma margari foo kul dobandi nga hinnaa ga kaɗ goo hugu-izoo ra nda zeeri.
2. Margari foo kul tee, ma margari-izey hinnaa hantum hugu-izoo ra, kaɗ goo a cire.

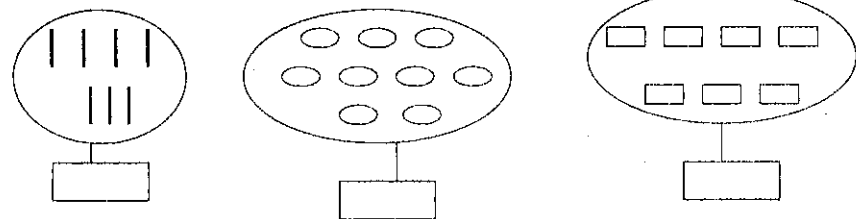

3. Biyey wey berandi, ma hugu-ize foo kul hinnaa biyey tee nga margaroo ra nda margari-izeyaɗ.

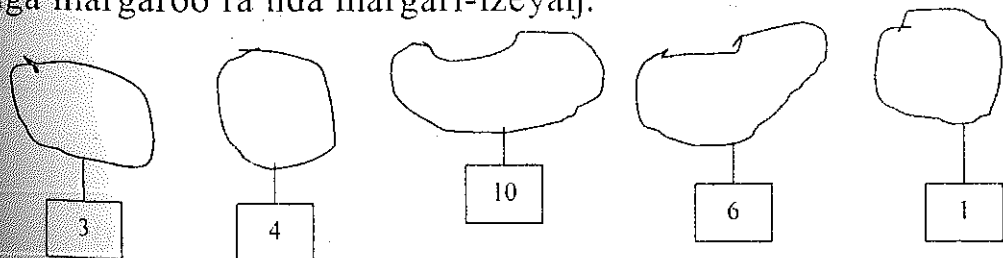

4. Biyey wey berandi, ma margari foo kul hinnaa hantum hugu-izoo ra kaŋ goo a cire.

5. Wey berandi ma margari foo kul dobandi hugu-izoo ga kaŋ nga nda hinnaa ga sawa.

| | | |
|-------|-----|-------|
| $4+3$ | 9 | $5+2$ |
| $5+4$ | 4 | $3+6$ |
| $1+3$ | 7 | $2+2$ |

6. Margarey wey tee m'i timmandi.

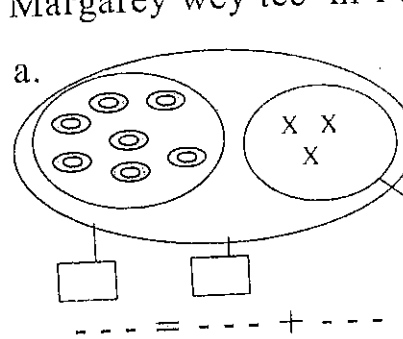
a.  $\square + \square = \text{---} + \text{---}$

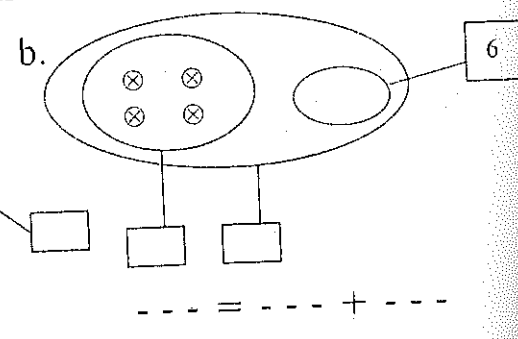
b.  $\square + \square + \square = \text{---} + \text{---}$ 6

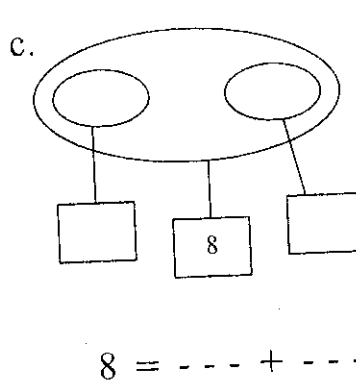
c.  $8 = \text{---} + \text{---}$

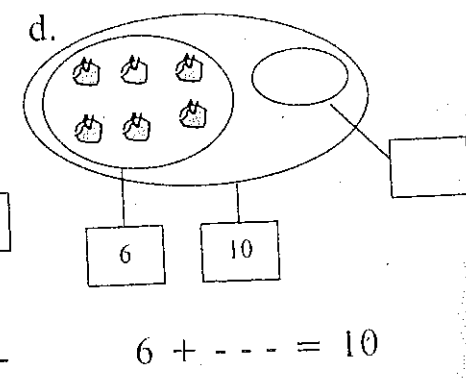
d.  $6 + \text{---} = 10$

7. Wey berandi, m'i timmandi.

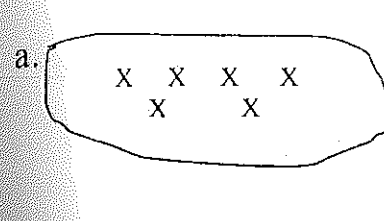
a. 

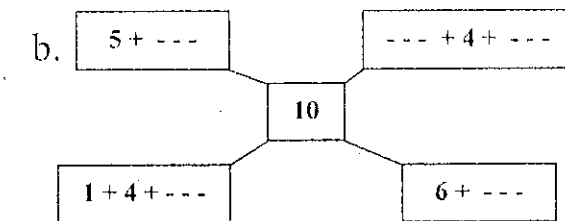
b. 

8. Wey berandi, m'i timmandi nda tammaasawey wey

$<$; $>$; $=$

9. Jinawey wey marga iwoy-woy.

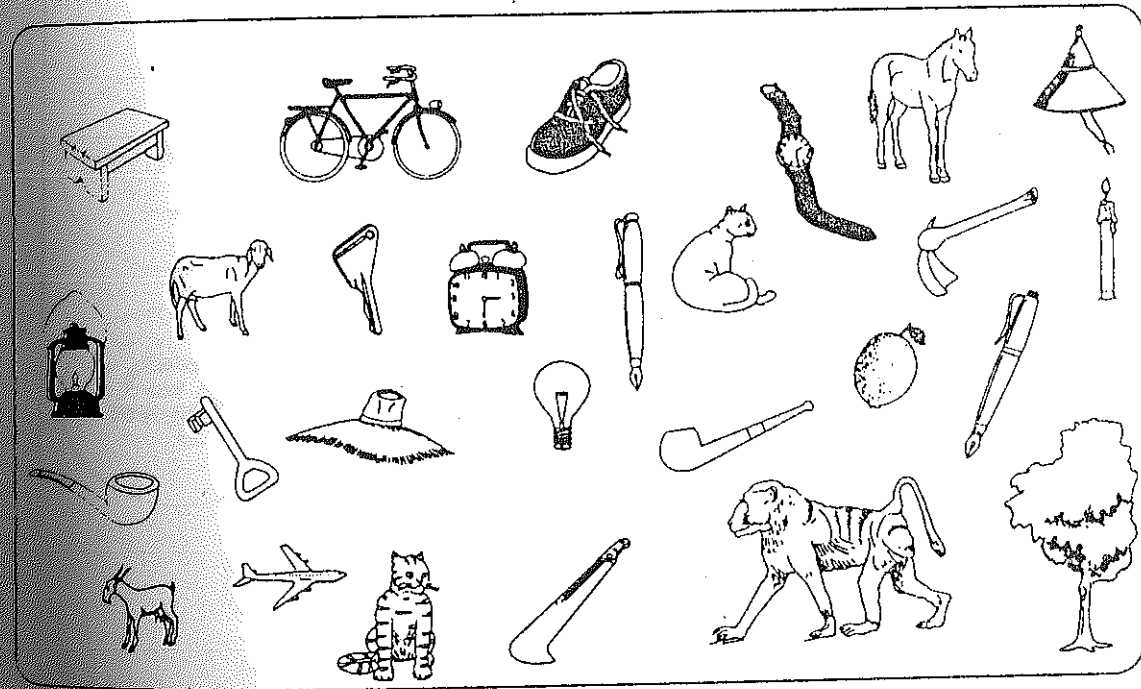

Filla : 0 ka koy 10 hinnawey

Alfagaa ma nee taalibey ma dendeney wey tee.

Denden

1. Margarey biyey tee, ma margari-izey hinnaa hantum hugoo ra kaŋ goo a cire.

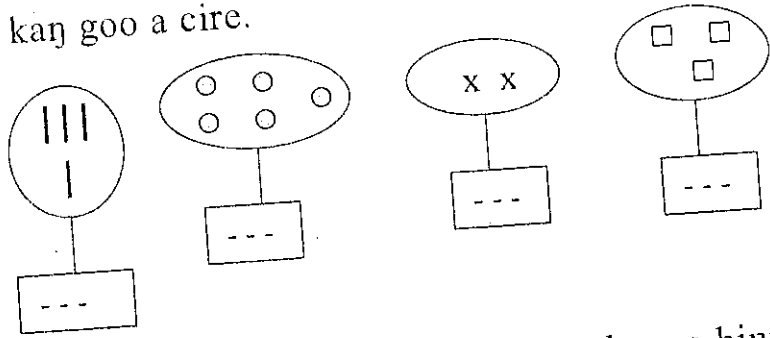

2. Biyey wey tee, ma margari foo kul nda nga hinnaa dobandi.

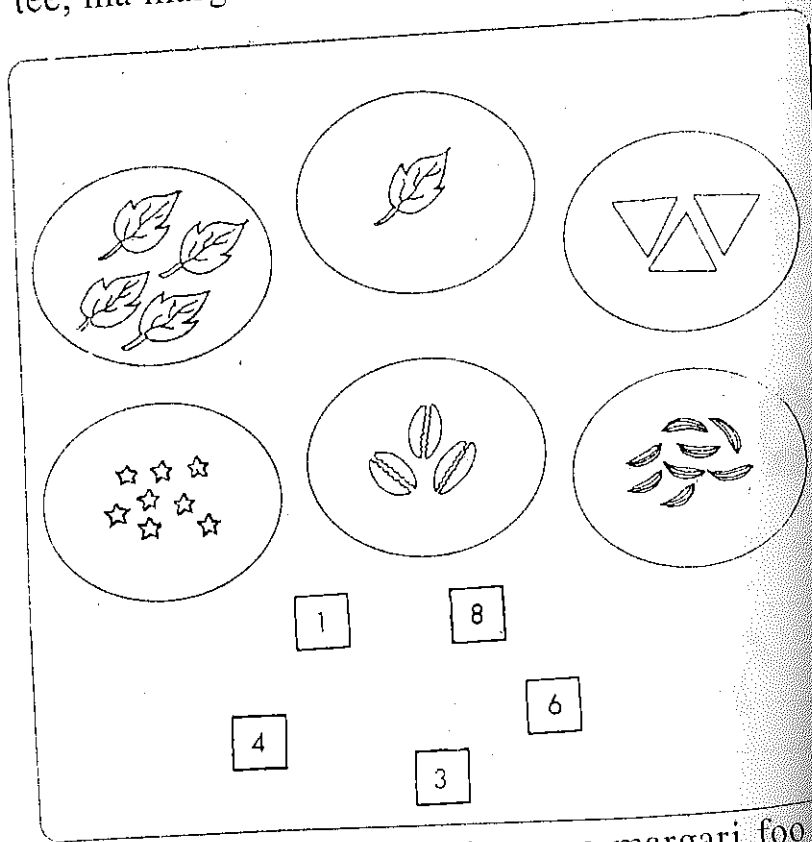

3. Biyey wey tee, ma tonbey hinnaa kaŋ goo margari foo kul ra biyey tee, i ma sawa nda kabu-izey kaŋ ga dobu i ga.

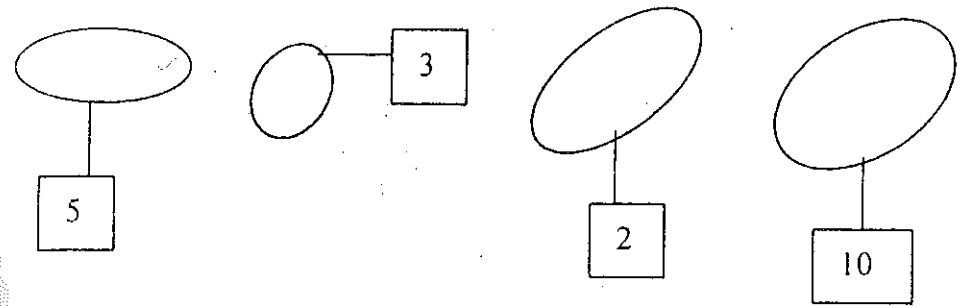

4. Biyey wey tee, ma hinnawey hantum i cire.

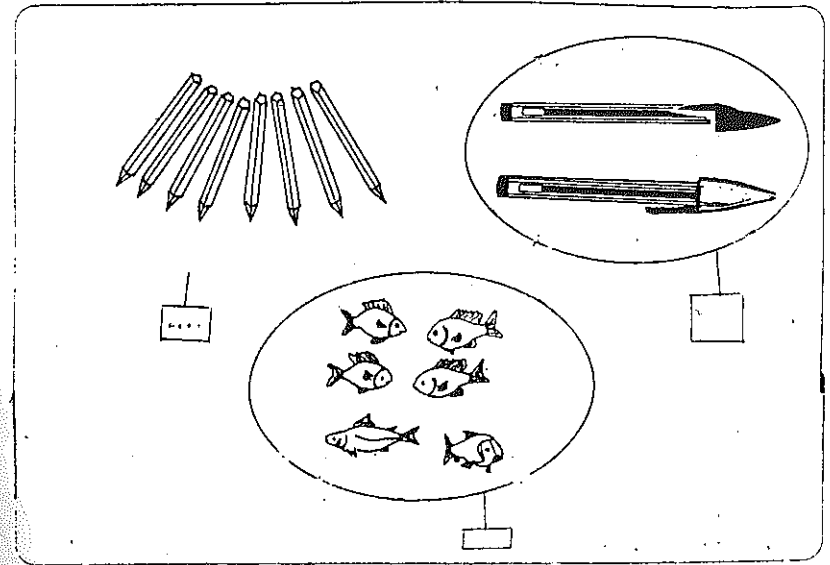

5. Wey berandi, ma hinnaa foo kul dobandi nga fesufesuyanoo ga.

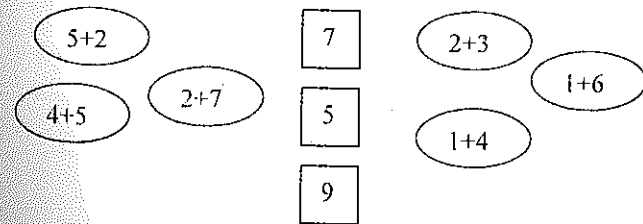

6. Biyey wey tee, m'i timmandi.

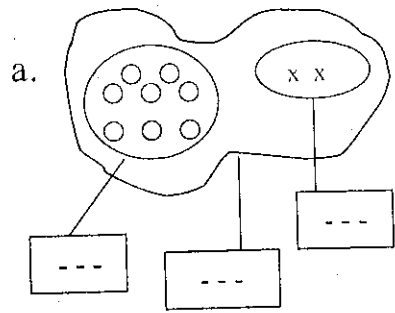

$$--- = --- + ---$$

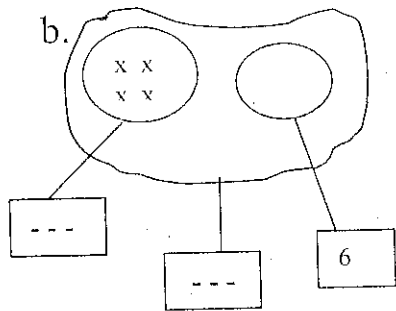

$$10 = --- + ---$$

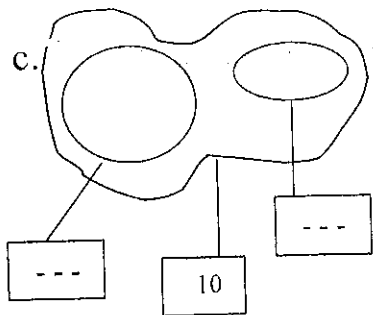

$$10 = --- + ---$$

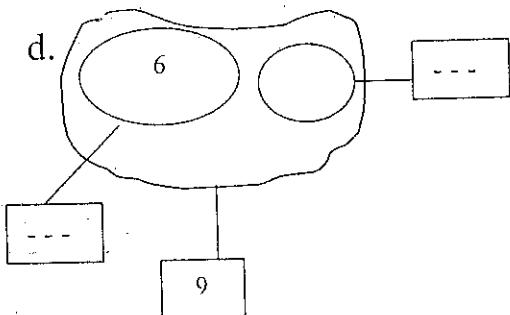

$$6 + --- = 9$$

7. Biyey tee, ma affoo kul hinnaa hantum hugoo ra kañ goo a cire.

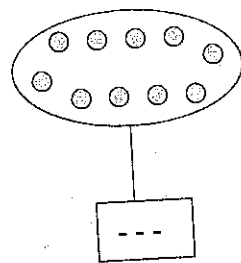
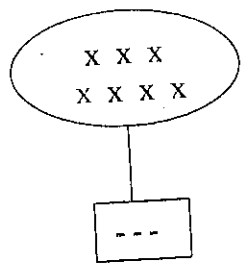

8. Kabu-izey wey berandi, m'i timmandi.

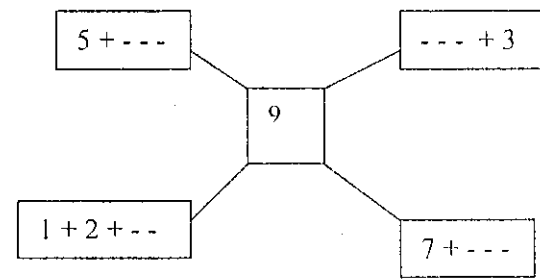

9. 0 ka koy 10 hinnawey hantum kabu-ize nda harfu ra.

10. Hinnawey wey berandi, ma tammaasawey wey $<$, $>$, $=$ dam tonbey dogey ra kañ ra i ga hima ka huru.

$$8 --- 10; \quad 2 + 8 --- 10; \quad 9 --- 0$$

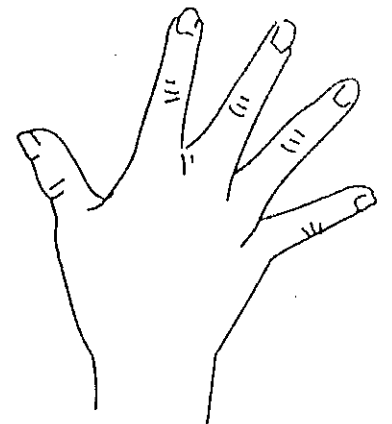
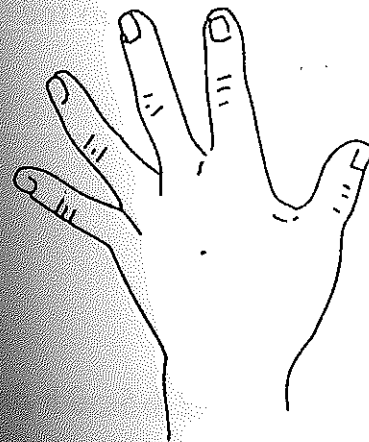

4. Biyey berandi m'i timmandi.

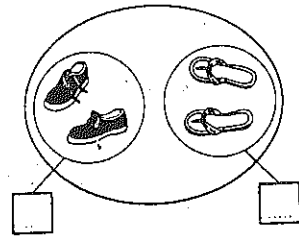

--- + --- = ---

5. Tuuri fitawey wey berandi ma ngi hinnaa hantum.



--- + --- = ---

6. Tontonyaney kabu ma zaabey hantum:

$1 + 3 =$ $1 + 1 =$ $2 + 3 =$
 $4 + 1 =$ $2 + 2 =$ $1 + 2 =$

7. Biyey wey berandi m'i timmandi.

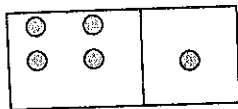

--- + --- = ---

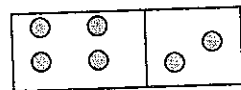

--- + --- = ---

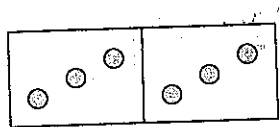

--- + --- = ---

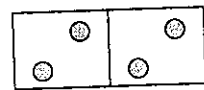

--- + --- = ---

8. Biyey berandi, m'i fersi, m'i timmandi.

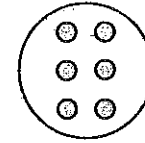
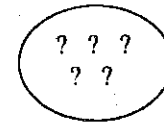
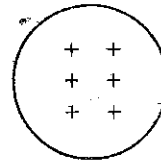

--- + --- =

--- + --- = 5

--- + --- = 6

9. Tontoney wey tee ma zaabey dam.

$1 + 2 =$ $3 + 3 =$ $1 + 5 =$
 $2 + 3 =$ $1 + 4 =$ $2 + 4 =$

10. Daaroo woo berandi m'a timmandi.

| | | | |
|---|---|---|---|
| + | 5 | 4 | 6 |
| 1 | | | |
| 2 | | | |
| 3 | | | |

Goy taacantoo : Aliyyu goo nda leemur-ize 7, woymaa n'a noo leemur-ize 0. Marje ti Aliyyu leemur-izey hinnaa ?

Alfagaa ma nee taalibey m'a hantum $7 + 0 = 7$; $0 + 7 = 7$.

Denden

1. Tontonyaney berandi m'i timmandi.

$2 + --- = 4$; $3 + --- = 8$; $7 + --- = 10$; $--- + 0 = 0$

$--- + 1 = 5$; $6 + --- = 9$; $1 + --- = 2$; $6 + --- = 7$

$--- + --- = 10$; $2 + --- = 3$.

2. Tontonyan daaroo woo tee m'a timmandi.

| + | 0 | 1 | 2 | 3 | 4 | 5 |
|---|---|---|---|---|---|---|
| 0 | | | | | | |
| 1 | | | | | | |
| 2 | | | | | | |
| 3 | | | | | | |
| 4 | | | | | | |
| 5 | | | | | | |

Goy guwantoo : Biyey wey berandi m'i timmandi.

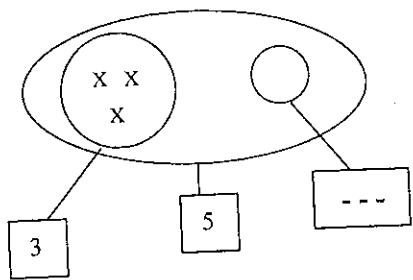

Denden

Tontonyaney wey berandi m'i timmandi.

$$4 + \text{---} = 8; \text{---} + 5 = 10; 9 + \text{---} = 9$$

$$1 + \text{---} = 3; \text{---} + 5 = 5$$

Iřeta goo nda karta-ize 6 taabaloo boŋ. Alfagaa na affooyan tonton a se. Iřeta goo nda karta-ize 9 taabaloo sohõ. Karta-ize marje no alfagaa n'a noo ?

Denden

1. Tontonyaney wey berandi m'i timmandi.

$$9 + 1 = ; 5 + 3 = ; 2 + 4 = ; 0 + 4 = ; 6 + 4 =$$

$$5 + 2 = ; 3 + 0 = ; 4 + 4 = ; 2 + 0 = ; 3 + 3 =$$

2. Mahamar na beerikaw 4 zaa ka nga faaroo goy, Haalidu na boro 6 sanb'a se. Boro marje bara faaroo ra ?

3. Faadimaata na lefe 7 kay ; ize woyoo na lefe 2 kay a se. Marje ti Faadimaata lefawey hinnaa ?

4. Yoonaa nd'izoo na kusu 10 kar cere ra. Yoonaa na 6 kar, kusu marje no izoo kara ?

5. Biyey tee m'i timmandi.

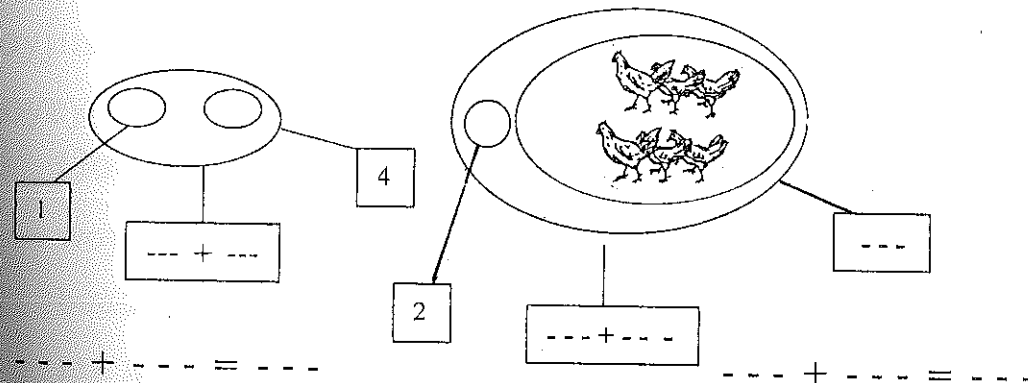

6. Muusa goo nda gorgo 7 ; a na gorgo 2 day. Gorgo marje bara a se sohõ ?

7. Isaa goo nda kalam 3, baaboo n'a noo kalam 4. Kalam marje bara Isaa se ?

8. Tontonyan daaroo berandi m'a timmandi.

| | | | | |
|---|------|------|------|------|
| + | 2 | ---- | 5 | ---- |
| 0 | ---- | 4 | ---- | 3 |
| 5 | ---- | ---- | ---- | ---- |

9. Salaamata goo nda leemurba 3, jaŋoo na affoo tanayan zamni izey game. Salaamata goo nda leemurba 5 sohō. Leemurba marje no jaŋoo n'a noo ?



Caw : 10 ka koy 19 hinnawey

Taasiha : Taaliboo ma hin :

- ka margari-izey kaŋ goo margari ra hinnaa bay ;
- ka 20 ka koy 29 hinnawey caw, k'i hantum kabu-ize nda harfu ra ;
- ka margari tee kaŋ ra margari-ize 10 goo; ka iwoy boŋey nd'affowey kabu ka jaaboo hantum ;
- ka hinna fesu-fesu k'a cin 20 ka koy 29 hinnawey (iwoyey nd'affowey) ;
- ka margari tee kaŋ margari-izey ga bayrandi ;
- ka hanga-hangandi cere bande, 20 ka koy 29 hinnawey.

Goyjinawey : Tondi-ize, bundu-ize, kalam.

Goyey

Goy jinaa : Alfagaa ma nee taalibi foo kul ma bundu-ize woy kabu. I m'i dii ngi kanbe gumey ra. A ma nee i ma bundu-ize foo zaa k'a tonton ijinawey ga. Waati din alfagaa ma nee taalibey se 1 tonton 10 ga (taalibi boobo m'a har). Alfagaa ma yee ka nee 10 tonton 1 ga, ga sawa nda 11 ($10 + 1 = 11$), taalibey ma woo da har. Alfagaa ma 11 hantum kabu-ize nda harfu ra sanda :

11 = iwoy cindi foo. A ma 11 hantum daaroo ra sanda :

| | |
|---|---|
| 1 | 0 |
| 1 | 1 |

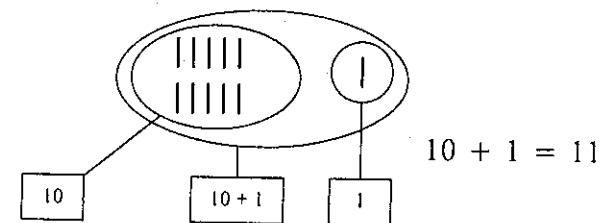

Taka follokaa kaɗ nda alfagaa na 11 cawandi taalibey se nd'a ga hinnawey kaɗ cindi cawandi hala iwoy cindi yagga (19). Affoo kul ra a ma nee taalibey ma iwoy boɗey nda affowey cebe i ma daaroo tee sanda

| | |
|---|---|
| i | a |
| 1 | 1 |

Goy hinkantoo : Alfagaa ma kalam 3 nda tondi-ize 6 nda bundu-ize 5 fur taabal foo kul boɗ a ma taalibey hãa. Jinay marje bara taabal foo kul boɗ ?

Alfagaa ma naɗ taalibey ma zaaboo ceeci, waati din a m'i hãa nda ngi goyoo fahamandoo.

Alfagaa ma nee taalibey ma goyoo woo biyoo tee ngi walhawey ga, i ma hinnawey tonton cere ga ka duu dimmaa.

Goy hinzantoo : Aliyyu goo nda tamaati 5, ceroo na tamaati 6 sanb'a se, Isaa yee k'a noo tamaati 4. Tamaati marje bara Aliyyu se ? Goyoo tee nda taka kaɗ nd'a tee beene.

Goy taacantoo : Alfagaa ma nee taalibey ma denden 8^{ntoo} tee.

Denden : Jinawey kaɗ ga kuma biyey tee, ma goyoo timmandi.

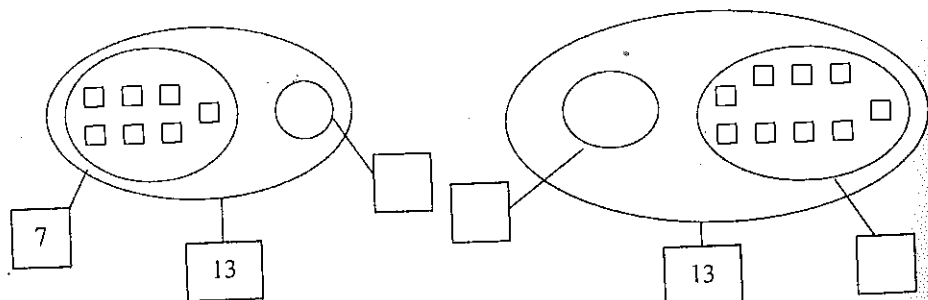

$$13 = 7 + \text{---}$$

$$13 = \text{---} + \text{---}$$

Denden

1. Tontonyaney berandi m'i timmandi.

$$10 + \text{---} = 11 ; 5 + 5 \text{---} = 14 \quad 10 + \text{---} = 16$$

$$4 + \text{---} = 12 ; 6 + 4 + \text{---} = 17 \quad 4 + 4 + \text{---} = 18$$

$$9 + \text{---} = 13 ; 3 + 5 + \text{---} = 15 \quad 10 + 8 + \text{---} = 19$$

2. Kabey wey berandi, m'i timmandi.

$$7 + 3 + 3 = \quad 8 + 2 + ? =$$

$$6 + 4 + 4 = \quad 9 + 1 + 8 =$$

$$4 + 8 + 2 = \quad 17 + 1 + 1 =$$

3. Daaroo woo tee m'a timmandi.

| | | | | |
|----|---|---|---|---|
| + | 3 | 5 | 7 | 2 |
| 10 | | | | |
| 11 | | | | |

4. Daaroo woo tee m'a timmandi.

| | | | | |
|----|---|----|---|---|
| + | 3 | | 8 | 9 |
| 5 | | 11 | | |
| 10 | | | | |
| 4 | | | | |

5. Wey hantum, ma hinna 2 zaa ka sasawandiyanoo timmandi.

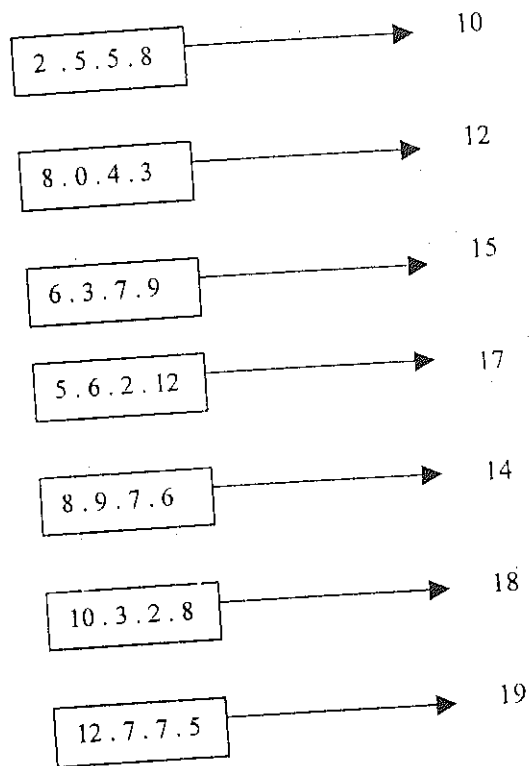

6. Wey hantum, m'i timmandi.

$$\begin{aligned} & \text{---} + 2 + 12 = 19; \quad \text{---} + 3 + 11 = 18; \quad 9 + 1 + \text{---} = 13 \\ & 1 + 10 + \text{---} = 17; \quad 5 + 6 + \text{---} = 14; \quad \text{---} + \text{---} + 6 = 15 \\ & 10 + \text{---} + 4 = 16; \quad 8 + \text{---} + 2 = 12; \quad 14 + 2 + \text{---} = 18 \end{aligned}$$

7. Jinawey kaŋ ga kuma biyey tee, ma goyoo timmandi.

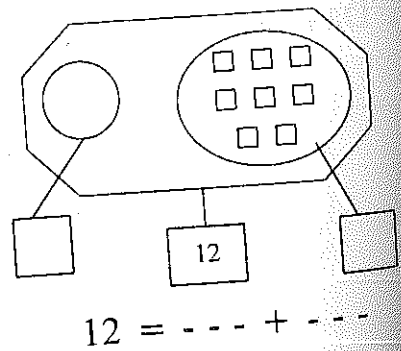
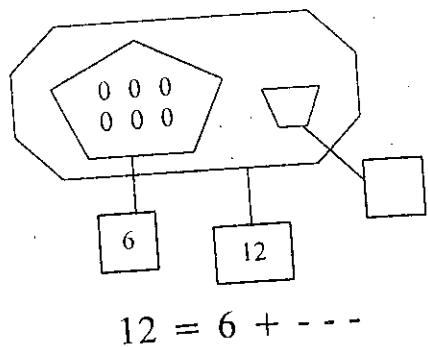

Caw : Tontonyan maanaa nda teeyanoo

Taasiha : Taaliboo ma hin :

- ka tontonyan tee nda goyjinawey ;
- ka tontonyan kabu dumey suka k'i tee.

Goyjinawey : Tondi-ize ; bundu-ize ; taaliboo tiiraa.

Goyey

Goy jinaa : Yuunusa goo nda kangaw 12 ; armaa n'a noo kangaw 7. Marje ti Yuunusu kangawey hinnaa kul cere ra ?

Alfagaa ma taalibey hãa wala taka foo nda i ga tontonyanoo tee nda goyjinawey (boŋey* nda kaarewey).

Alfagaa ma nee taalibey ma goyjinawey tonton cere ga ka duu dimmaa, i m'affowey nda iwoy boŋey kaa cere ra. Woo banda ga i ma goyoo biyoo tee sanda :

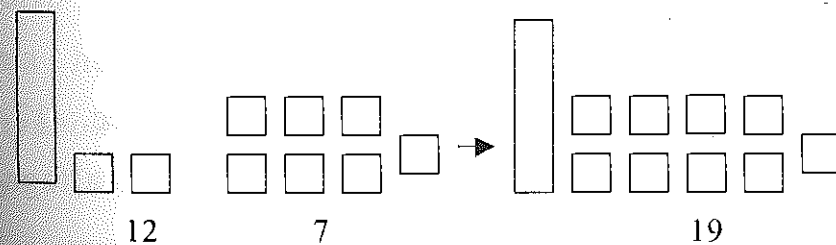

Goy hinkantoo : Alfagaa ma nee taalibey ma 12 + 7 hantum sorra ra.

* boŋ : hawari, muulubii (une barre c'est-à-dire un assemblage d'objets de même nature : ex. : fagot de bois, etc.)

- Alfagaa ma nee taalibey ma hinna foo kul boŋey nda kaarewey biyey tee daaroo ra sanda :

| | |
|------------------|-------------------------------|
| Kaj huru cere ra | □ □ |
| | □ □ □ □ □ □ □ |
| Zaaboo | □ □ □ □ □ □ □ □ □ □ □ □ |

- Alfagaa ma nee taablibey ma zaaboo hantum. Taalibey ma yee goyoo ga nda hinna tana fooyan cee boobo (tontonyan ra bila lanbari).

Goy hinzantoo : Alfagaa ma nee taalibey ma hinnabayray daaroo tee.

| | |
|---|---|
| □ | □ |
| + | |
| = | |

- Alfagaa ma nee taalibey ma kaboo woo tee : $12 + 7$. Nda taalibey mana hin k'a tee daaroo ra, alfagaa m'i daŋ fonda ra. Affowey sorraa ra $2 + 7 = 9$; iwoy boŋey sorraa ra $1 + 0 = 1$; a kul hinnaa ga sawa nda 19.
- Alfagaa ma nee taalibey ma kaarewoo barmay nda affowey (i m'i hantum harfu ra); i ma boŋoo barmay nda iwoy boŋey (i m'i hantum harfu ra).

Woo banda ga i ma affowey barmay nda « a », i ma iwoyboŋey barmay nda « i », sanda :

| | | | | |
|--------|---------|------|---|---|
| Iwoyey | Affowey | | i | a |
| 1 | 2 | wala | 1 | 2 |
| + | 7 | + | | 7 |
| = 1 | 9 | = | 1 | 9 |

$$\underbrace{12}_{\text{wala}} + 7 = 19$$

Alfagaa ma nee : ir na tontonyan kaboo suka ngi n'a tee nda 12 nda 7.

Duurandi - (Alfagaa nda taalibey m'a cin nda cere)

Nda boro ga tontonyan tee, boro mma kabu-izey duma nda sorro; affowey ma huru affowey cire, iwoy boŋey mo ma huru cere cire. Woo banda ga boro ga tontonyanoo tee sorro nda sorro ka sintin nd'affowey sorraa.

Denden : Tontonyaney wey duma, ma zaabey hantum :

$$13 + 4; 14 + 3; 3 + 16; 12 + 5; 16 + 3.$$

Denden

1. Daaroo woo berandi ma zaaboo hantum.

| | | | |
|--|--|--|--|
| | | | |
| | | | |
| | | | |

| | |
|---|---|
| 1 | a |
| 1 | 3 |
| | |
| | |

2. Kabey suka daaroo woo cine ra ma zaabey daŋ.

| | | |
|--------|---|---|
| 18 + 1 | 1 | a |
| 15 + 3 | - | - |
| + | - | - |
| = | | |

Tontonyanoo woo tee nda goyjinawey : 11 + 7
Tontonyanoo daŋ daaroo ra ma zaaboo hantum.

4. Kabu-izey suka ma zaabey hantum

$$15 + 1; \quad 17 + 2; \quad 13 + 5$$

5. Taalibi woy 11 nda taalibi aru 7 goo cawhugoo ra. Taalibi marje bara cawhugoo ra ?

6. Isaa na goykaw 10 zaa nga garoo cinaroo hane. Kaŋ guuru 10 ga too, boro 5 kaa ka tonton goykey ga.

Boro marje ka Isaa garoo goy ?

7. Garaasa na huryaw 12 hanse hō subbaahoo, alaasaroo ra a na huryaw 7 tee. Huryaw marje no garaasaa n'a hanse hō zaaroo ?

Caw : 20 hinnaa

Taasiha : Taaliboo ma hin :

- ka margari-izey kaŋ goo margari ra hinnaa bay ;
- ka 20 cin k'a caw k'a hantum kabu-ize nda harfu ra ;
- ka 20 fesu-fesu k'a cin ;
- ka hinnawey hanga-hangandi cere bande 0 hala 20 ga.

Goyjinawey : tondi-ize, bundu-ize, batayaŋ.

Goyey

Goy jinaa : Alfagaa ma taalibey tee kurayyaŋ. A ma nee kuray foo kul ma margari tee kaŋ ra margari-ize 19 goo.

- Alfagaa ma nee taalibey ma hinnaa hantum kaŋ i duu a.
- Alfagaa ma nee taalibey ma 1 tonton 19 ga. A m'i hāa nda hinnaa kaŋ i duu a. Nda taalibey mana duu zaaboo, a ma har. A ma nee taalibey m'a caw cee boobo ; a m'a hantum walhabeeroo ga, taalibey m'a berandi sanda :

$$19 + 1 = 20 \quad \text{wala} \quad 1 + 19 = 20$$

- Alfagaa m'a hantum nda harfu, taalibey ma yee a ga.

Goy hinkantoo : Alfagaa ma tondi-ize 20 biyey tee walhabeeroo ga, a ma nee taalibey m'i kanandi nda 10-10. A m'i hāa nda 10 boŋ hinnaa kaŋ i duu ey.

Alfagaa ma bayrandi taalibey se kaŋ 10 kanandi foo kul ti 10 boŋ foo.

Alfagaa ma taalibey hāa nda 10 boŋ hinnaa kaŋ goo 20 ra. A ma nee i ma iwoyey nda affowey hinnawey har.

Goy hinzantoo : Alfagaa ma nee taalibey ma 20 fesu-fesu k'a cin.

Denden

1. Kabey berandi, ma ngi fesu-fesuyanoo tee.

$$20 = \dots + 4 ; 18 = \dots + \dots ; 15 = 12 + \dots ; 13 = \dots + \dots ;$$

2. Kabey berandi.

$$15 + 5 = \dots ; 13 + 7 = \dots ; 14 + \dots = 20 ; \dots + 12 = 20.$$

3. Tontonyan daaroo berandi, m'a timmandi.

| + | 0 | 1 | 2 | 3 | 4 | 5 | 6 | 7 | 8 | 9 | 10 |
|----|---|---|---|---|---|---|----|---|---|----|----|
| 0 | | | | | | | | | | | |
| 1 | | | | | | | | | | | |
| 2 | | | | | | | | | | | |
| 3 | | | | | | | | | | | |
| 4 | | | | | | 9 | | | | | |
| 5 | | 6 | | | | | | | | | |
| 6 | | | | | | | 12 | | | | |
| 7 | | | | | | | | | | | |
| 8 | | | | | | | | | | 18 | |
| 9 | | | | | | | | | | | 20 |
| 10 | | | | | | | | | | | |

Goy taacantoo : Alfagaa ma 20 deedandi nda hinnawey kaɗ taalibey n'i caw ka bisa. A ma nee taalibey m'i hanga-hangandi cere bande.

- Alfagaa ma nee taalibey ma hinnawey kul kaɗ i n'i caw durse, ka hun ikaccaa ga ka koy ibeeroo ga, i ma yee ka hun ibeeroo ga ka koy ikaccaa ga.

Denden

Kabu-izey wey berandi, m'i hanga-hangandi cere bande ka hun ikaccaa ga ka koy ibeeroo ga : 1 ; 4 ; 5 ; 3 ; 6 ; 2 ; 7 ; 9 ; 11 ; 10 ; 14 ; 16 ; 18 ; 12 ; 20 ; 19 ; 13 ; 8 ; 15 ; 17.

Kabu-izey wey berandi m'i hanga-hangandi cere bande ka hun ibeeroo ga ka koy ikaccaa ga.

Denden

1. Biyey wey tee, ma hayey kaɗ ga kuma timmandi.

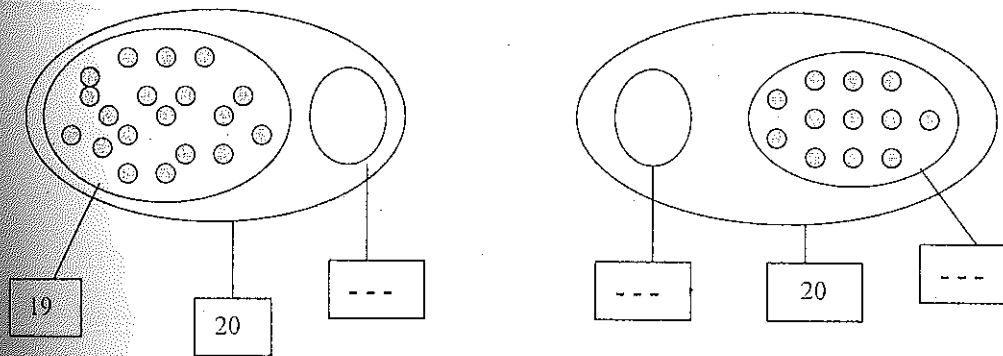

$$20 = 19 + \dots ;$$

$$20 = \dots + \dots$$

2. Wey berandi ma 20 - 20 hantum ka koy.

$$\begin{array}{r} 20 \quad 20 \quad 20 \\ \hline \end{array}$$

3. Biyey wey berandi ma wey kaɗ kuma dam k'i timmandi.

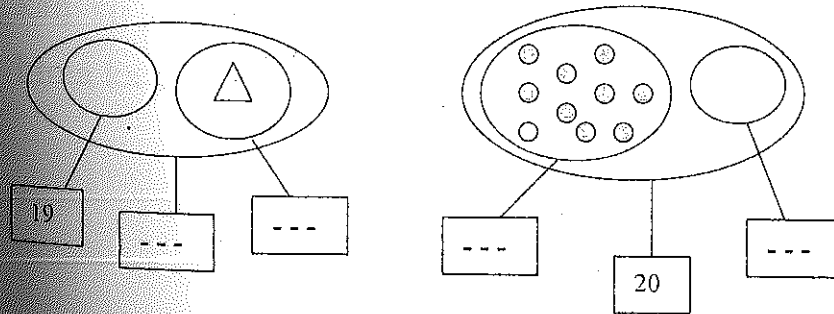

4. Harfey berandi ma ngi hinnaa hantum.

| | |
|-----------------------|-----|
| b c d f g h j k l m p | --- |
| q n r s t w y z | |

5. Biyey wey berandi, m'i tee kurayyan kan affoo kul goo nda margari-ize 10, ma daaroo timmandi.

| | | | | | | | | | |
|---|---|---|---|---|---|---|---|---|---|
| x | x | x | x | x | x | x | x | x | x |
| x | x | x | x | x | x | x | x | x | x |
| x | x | x | | | | | | | |

| Iwoyey | Affowey |
|--------|---------|
| --- | --- |

6. Kabu-izey wey berandi m'i timmandi :

$12 + \dots = 20$; $6 + \dots = 20$; $14 + \dots = 20$; $15 + \dots = 20$;
 $\dots + 0 = 20$; $\dots + 10 = 20$; $\dots + 3 = 20$; $\dots + 9 = 20$;
 $17 + \dots = 20$.

7. Tontonyan daaroo woo berandi m'a timmandi.

| + | 3 | 6 | 8 | 9 |
|----|-----|-----|-----|-----|
| 5 | --- | --- | --- | --- |
| 11 | --- | --- | 19 | --- |
| 7 | --- | --- | --- | --- |

Caw : Hinnabayray iwoy boŋ ra

Taasiha : Taaliboo ma hin :

- ka kanandi tee kan ra jinayyan goo, k'i kabu ;
- ka kabu-izey dogey bay hinna ra ;
- ka goy nda hinna bayray goyjinawey.

Goyjinawey : Tondi-ize, bundu-ize, kalam.

Goyey

Goy jinaa : Alfagaa ma nee taalibey ma bundu-ize 1 ka koy 3 ga, zaa. A ma nee taalibey m'i kanandi nd'ihinka-hinka. Alfagaa ma taalibey hãa nda kanandey hinnaa kan i n'i tee nda wey kan sii kanandi ra.

- Alfagaa ma taalibey noo bundu-ize 5 ka koy 24 hinnawey. A ma nee taalibey m'i kanandi igguu-guu. Woo din banda ga i ma kanandey hinnaa kan i duu ey nda wey kan sii kanandi ra hinnaa har.

Goy hinkantoo : Alfagaa ma jinay 5 ka koy 24 hinnawey margaroo biyey tee sanda beene goyoo takaa walhabeeroo ga. A ma taalibi foo sanba walhabeeroo ga a m'i kanandi nda igguu-guu.

Alfagaa ma nee taalibey ma kanandey hinnaa nda wey kan sii kanandi ra hinnaa kabu. Biyoo woo no taalibey ga hima ka duu a.

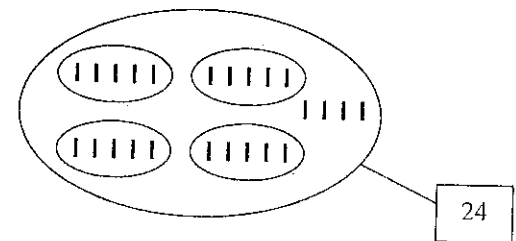

Denden : Alfagaa ma nee taalibey ma goy jinaa biyoo tee.

Goy hinzantoo : Biyey berandi m'i kanandi : a) nda ihinka-hinka ; b) : nda igguu-guu m'i timmandi.

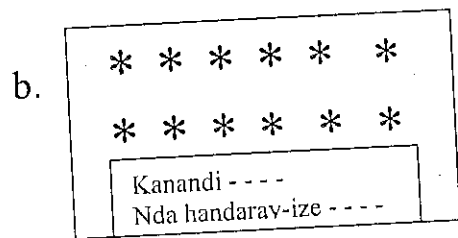
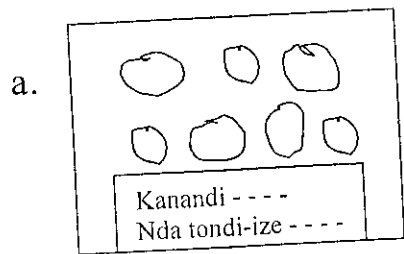

Goy taacantoo : Alfagaa ma taalibey noo jinayyan (1 ka koy 99). A ma nee i m'i kanandi nda iwoy-woy. A ma nee taalibey ma kanandey kan ra 10 goo nda wey kan sii kanandi ra hinnaa har.

Alfagaa ma bayrandi taalibey se kan iwoy kanandi foo kul ti iwoy boŋ, wey kan sii kanandi ra ti affowey (a).

Denden : Biyey wey berandi m'i kanandi nda iwoy-woy. Iwoy kanandey hinnaa nda wey kan sii kanandi ra hinnaa har.

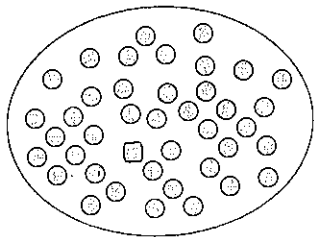

Goy guwantoo : Alfagaa ma margari bii tee walhabeeroo ga kan ra bundu-ize 30 goo. A ma nee taalibi foo ma kaa k'i kanandi nda iwoy-woy.

Alfagaa ma hantum walhabeeroo ga : iwoy boŋ 3 nda affowey 0.

Taalibey m'i hantum daaroo woo ra. Alfagaa ma nee taalibey se daaroo woo se i ga nee hinnawey daaroo.

Sanda :

| | |
|---------|---------|
| Iwoywey | affowey |
| 3 | 0 |

wala

| | |
|---|---|
| i | a |
| 3 | 0 |

Alfagaa m'a cawandi nda takaa woo : iwoy boŋ 3 nda affowey 0. Alfagaa masi nee «waranza».

Alfagaa ma iwoy kanandi cebe, a ma nee : «woy ti iwoy boŋ».

Alfagaa ma hantum walhabeeroo ga : bundu-ize 10 = iwoy boŋ 1. Alfagaa ma nee taalibey se iwoy boŋ ga tee muulubiyoo woo wala woo ; affowey ma tee kaare kan nga cine woy ti muubiyoo.

Alfagaa ma nee taalibey se kan muulubiyey nda kaarewey ti hinna goyjinawey. A ma nee taalibey se kan muulubii foo ga sawa nda kaare woy wala boro ga hin ka kaare woy barmay muulubii foo.

Denden : iwoy boŋ 3 nda affowey 0 tee nada hinna goyjinawey.

Alfagaa ma nee taalibey ma margari tee kan ra margari-ize 35 goo ; i m'i kanandi nda iwoy boŋ sanda : iwoy boŋ 3 nda affowey 5 (kan sii kanandi ra).

- Alfagaa ma nee taalibey ma bundu-izeyan kanandi, i m'i haw nd'iwoy-woy. Taalibey ma iwoy boŋey kabu: iwoy boŋ 1, iwoy boŋ 2, iwoy boŋ 3 . . .
- Alfagaa ma nee taalibey ma zaabey dam hinnawey daaroo ra. I ma zaaboo tee nda hinna goyjinawey.

Hinna daaroo :

| | |
|---|---|
| i | a |
| 3 | 0 |

Hinna goyjinawey :



Denden

1. Biyey berandi m'i kanandi nda iwoy-woy, ma daaroo timmandi.

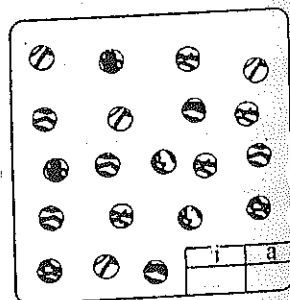
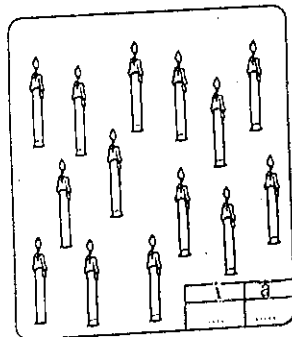

2. Iwoy boŋ marje bara daaroo woo ra?

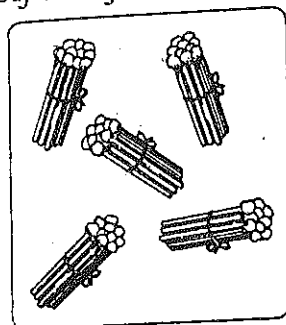

Iwoy boŋ -----

3. Biyey wey berandi m'i kanandi nda iwoy-woy, ma daaroo timmandi.

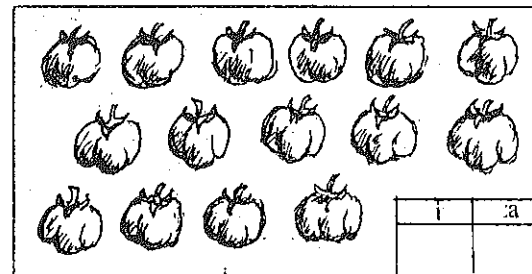

4. Margaroo woo timmandi ka duu iwoy boŋ foo.

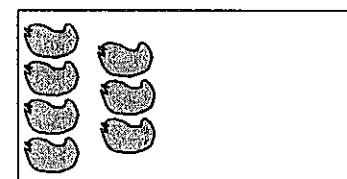

5. Kabu-izey berandi m'i timmandi nda tammaasawey :

< nda =

$$3 + 1 \text{ --- } 10 ; \quad 2 + 7 \text{ --- } 3 + 7 \quad 7 + 0 \text{ --- } 9$$

$$1 + 5 \text{ --- } 5 + 1 ; \quad 8 \text{ --- } 10 \quad 5 + 2 \text{ --- } 6$$

$$4 + 3 \text{ --- } 5 + 2 ; \quad 6 + 1 \text{ --- } 7 \quad 8 + 2 \text{ --- } 9$$

6. Zuwoo berandi m'a timmandi.

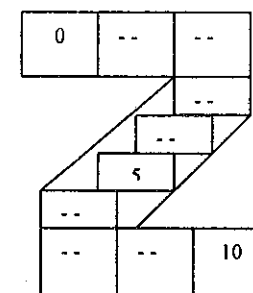

Caw : Tontonyan kaɗ sii nda lanbari

Taasiha : Taaliboo ma hin :

- ka mise boobo tee kaɗ ra tontonyan goo ;
- ka hinna 2 wala hinna 3 tonton cere ga ;
- ka tonton daaroo cin k'a durse ;
- ka duu hinna 2 tontonyan ra, hinnaa kaɗ ga kuma.

Goyjinawey : Tondi-ize, bundu-ize.

Goyey

Goy jinaa : Alfagaa ma taalibey tee kurayyanɗ.

A ma kuray foo kul noo bundu-ize 3, tondi-ize 2, nda kalam 4. Alfagaa ma kuray foo kul hãa nda hayey hinnaa kaɗ goo a kone. A ma taalibey naɗ i ma ceeci. Waati din a ma nee i ma filla takaa kaɗ nda i n'a tee ka duu zaaboo.

Alfagaa ma nee taalibey ma misaa biyey tee, i m'i hantum nda kabu-ize k'i sawandi.

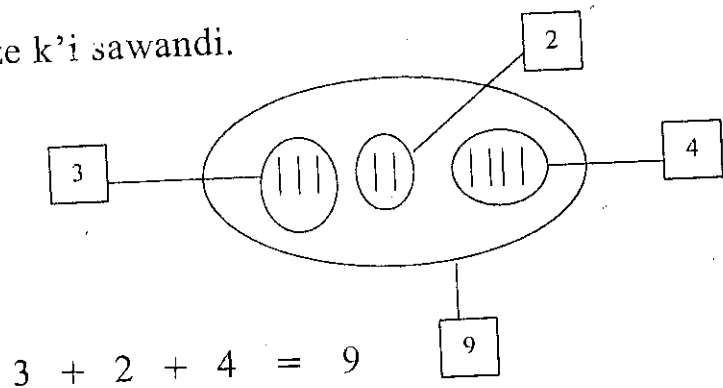

Goy hinkantoo : Zali goo nda tamaati 4, Maryama n'a noo tamaati 3, Haday yee k'a noo tamaati 2. Tamaati marje bara Zali se ?

Alfagaa ma nee taalibey ma misaa biyoo tee i m'a hantum nda kabu-ize k'a sawandi.

Goy hinzantoo : Alfagaa ma taalibey yaamar i ma goyoo kaɗ tee goy hinkantoo ra cine filla cee boobo ; i m'i tee nda cere k'i sawandi.

Denden

1. Tontonyaney wey tee ma zaabey dam.

$$4 + 5 = ; 3 + 5 + 6 = ; 2 + 4 + 3 = ; 8 + 5 + 2 = ;$$

$$10 + 10 = ; 6 + 8 = ; 9 + 9 =$$

2. Kabey wey berandi ma sawandiyanoo timmandi.

$$12 = 10 + \text{---} ; 14 = 13 + \text{---} ; 14 = \text{---} + 8 ;$$

$$13 = 12 + \text{---} ; 20 = \text{---} + 10 ; 18 = 14 + \text{---}$$

Goy taacantoo : Alfagaa ma biyey wey tee walhabeeroo ga.

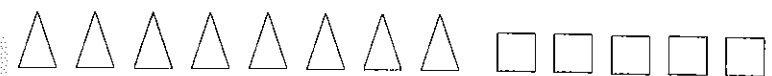

Alfagaa ma nee taalibey ma biyey wey hinnaa hantum nda taka boobo sanda :

$$\text{---} + \text{---} + \text{---} = 13$$

$$\text{---} + \text{---} = 13$$

$$\text{---} + \text{---} = 13$$

$$\text{---} + \text{---} = 13$$

- Alfagaa ma nee taalibey ma 13 hantum nda iwoy bon sanda $10 + 3 = 13$

Caw : 20 ka koy 29 hinnawey

Taasiha : Taaliboo ma hin :

- ka margari-izey kaṅ goo margari ra hinnaa bay ;
- ka hinnawey, 20 ka koy 29 caw, k'i hantum kabu-ize nda harfu ra ;
- ka margari tee kaṅ ra margari-ize 10 goo; ka iwoy boṅey nd'affowey kabu, ka zaaboo hantum ;
- ka kabu-izey dogoo bay hinna ra ;
- ka hinna cin k'a fesu-fesu, 20 k a koy 29 (iwoy boṅey nd'affowey) ;
- ka margari tee kaṅ margari-izey ga bayrandi ;
- ka hinnawey hanga-hangandi cere bande, 20 ka koy 29 ;
- ka hinnawey durse, 1 ka koy 29.

Goy jinawey : Tondi-ize, bundu-ize . . .

Goyey

Goy jinaa : Alfagaa ma nee taalibey ma iwoy boṅ 2 kabu m'i haw. A ma nee taalibi foo kul ma bundu-ize foo zaaboo m'a tonton iwoy boṅey ga. Alfagaa ma taalibey hāa hinnaa kaṅ nd'a ga sawa.

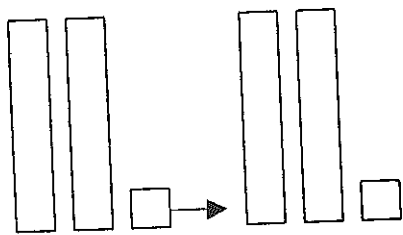

Nd'i mana duu a, a ma nee waranka cindi foo (20 + 1 = 21).
kaṅ affoo tonton a ga, ga sawa

Taalibi boobo m'a har. Alfagaa ma waranka cindi foo hantum kabu-ize nda harfu ra. Taalibey m'a caw, i m'a hantum kabu-ize nda harfu ra.

- Alfagaa ma taalibi foo cee a ma 21 hantum hinnawey daaroo ra sanda :

| | |
|---|---|
| I | a |
| 2 | 1 |

Takaa woo da nda alfagaa ga hinnawey kaṅ cindi, cawandi hala 29. Affoo kul ra a ma nee taalibey ma iwoy boṅey nda affowey cebe, i m'i hantum hinnawey daaroo ra.

Goy hinkantoo : Alfagaa ma taalibey tee kurayyaṅ. A ma kuray foo kul noo jinayyaṅ kaṅ hinnaa goo 20 nda 29 game. A ma nee taalibey m'i marga nda iwoy-woy ; a m'i hāa nda margarey hinnaa nda wey kaṅ sii margari ra hinnaa.

Denden : Daaroo woo guna ka daaroo kaṅ goo ciroo ra timmandi.

(a)

| Iwoy boṅ hinnaa | Affoo hinnaa | Hinna kabu-ize ra | Hinna harfu ra |
|-----------------|--------------|-------------------|---------------------|
| 2 | 6 | 26 | Waranka cindi iddu |
| 2 | 1 | 21 | Waranka cindi foo |
| 2 | 4 | 24 | Waranka cindi taaci |

b.

| Iwoy boŋ hinnaa | Affoo hinnaa | Hinna kabu-ize ra | Hinna harfu ra |
|-----------------|--------------|-------------------|----------------|
| 2 | 5 | | |
| 1 | 9 | | |
| 2 | 9 | | |
| 2 | 9 | | |

- Alfagaa ma nee taalibey ma margariyaŋ har ; woo din banda, i m'i hantum daaroo ra.
- Alfagaa ma nee taalibey ma hinnawey kaŋ ga sawa nda hantumey wey daŋ kabu-ize ra affoo kul jine.
 - Iwoy boŋ 2 nda affoo →
 - iwoy boŋ 1 nda affoo →
 - iwoy boŋ 2 nda affoo →

Goy hinzantoo : Alfagaa ma nee kuray foo kul ma bundu-izeyaŋ kaŋ bisa 30 kabu. A ma 25 hantum walhabeeroo ga. Alfagaa ma nee taalibey ma margari tee kaŋ ra margari-ize 25 goo. Alfagaa ma goyoo filla nda kabu-ize tanayaŋ kaŋ goo 0 nda 29 game. Waati din a ma hinnaa woo (26) hantum daaroo ra sanda :

| | |
|---|---|
| i | a |
| 2 | 6 |

Alfagaa ma nee : « iwoy boŋ 2 nda affowey 6 ga sawa nda waranka cindi iddu (26) wala $20 + 6$ ».

Goy taacantoo : Alfagaa ma 23 hantum walhabeeroo ga, a m'a cawandi. A ma nee taalibey ma hinnaa biyoo tee nda iwoy boŋ 2 nda affowey 3.

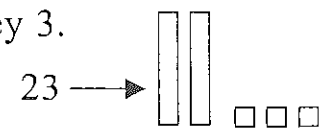

Alfagaa ma goyoo filla nda hinnawey kaŋ cawandi.

Goy guwantoo : Alfagaa ma 21 nda 12 hantum walhabeeroo ga nda kabu-ize. A ma nee taalibey ma biyey tee iwoy boŋ ra sanda :

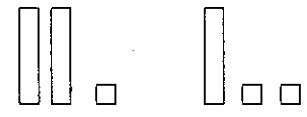

Taalibey ma iwoy boŋey nda affowey hinnaa har.

- Alfagaa ma nee waati din kaŋ : 2, waranka cindi foo ra ti iwoy boŋ 2 ; 2, iwoy cindi hinka ra ti affowey 2.
- Alfagaa ma kabu-ize foo kul dogoo fahamandi taalibey se ra ka hun 0 ka koy 29 hinnawey sanda :

| | |
|----|--------------------------|
| 26 | Iwoy boŋ 2 nda affowey 6 |
| 27 | Iwoy boŋ 2 nda affowey 7 |
| 28 | Iwoy boŋ 2 nda affowey 8 |

Taalibey ma iwoy boŋey nda affowey hinnaa har hinna ra.

0 ka koy 29 hinnawey

Alfagaa ma nee taalibey ma hinnaa foo kul hantum kabu-ize nda harfu ra sanda : iwoy boŋ 2 nda affowey 4 ga hantum nda (waranka cindi taaci).

Alfagaa ma hinnawey wey cin a m'i fesu-fesu walhabeeroo ga sanda

$$20 + 9 = 29 ; \quad 19 + 10 = 29 ; \quad 10 + 8 + 10 = 28$$

$$23 = 20 + 3 ; \quad 24 = 10 + 4 + 10 ; \quad 19 = 9 + 10.$$

Alfagaa ma dendenoo woo filla nda hinnawey 0 ka koy 29 ga.

Denden :

1. Tontonyaney wey tee.

$$12 + 10 = ; \quad 15 + 9 = ; \quad 17 + 12 = ; \quad 18 + 3 + 2 = ;$$

$$13 + 6 = ; \quad 16 + 11 =$$

2. Fesu-fesuyaney wey hantum, m'i timmandi.

$$26 = \text{---} + 12 ; \quad 22 = 9 + 6 + \text{---} ; \quad 24 = 13 + \text{---} ;$$

$$29 = 15 + \text{---} ; \quad 27 = 17 + \text{---} ; \quad 23 = 16 + \text{---} ;$$

$$28 = 18 + \text{---}$$

Goy idduwantoo : Alfagaa ma deedandi 0 ka koy 29 hinnawey.

Sanda : 10 ga kaa 20 jine ; woo ti 10 ga kacca nda 20.

A ga hantumandi nda : $10 < 20$ wala $20 > 10$.

Hinnawey ra kabu-izey dogey ga bara nda taka 2.

Taka jinaa : Alfagaa ma bayrandi taalibey se kanj hinnawey

sii nda iwoy boŋ hinna foo zama nd'ir na 12 nda 25 deedandi,

ir ga dii kanj ibeeroo ti woo kanj iwoy boŋ hinnaa ga bisa ceroo

sanda : $25 > 12$ wala $12 < 25$.

Taka hinkantoo : Hinnawey ra, iwoy boŋey ga hin ka

tee kabu-ize follokaa amma affowey kabu-izoo ga hin ka

barmay sanda : Ir ma 25 nda 21 deedandi.

Ne ra ir ga dii kanj hinna beeroo ti woo kanj affowey kabu-izoo ga bisa ceroo.

Denden : Hinnawey berandi m'i deedandi :

$$20 \text{ nda } 23 ; \quad 21 \text{ nda } 26 ; \quad 15 \text{ nda } 20 ; \quad 18 \text{ nda } 24$$

$$19 \text{ nda } 29 ; \quad 17 \text{ nda } 28 ; \quad 23 \text{ nda } 27 ; \quad 25 \text{ nda } 28.$$

Goy iyyantoo : Alfagaa ma hinnawey hanga-hangandi cere bande 0 ka koy 29 hinnawey.

A ma hinnawey wey hantum walhabeeroo ga :

$$21 ; 8 ; 5 ; 18 ; 7 ; 10 \text{ ka kaa } 0.$$

Taalibey m'i hanga-hangandi cere bande ka hun ikaccaa ga ka koy ibeeroo ga wala ka hun ibeeroo ga ka kaa ikaccaa ga.

Denden :

1. Hinnawey hanga-hangandi cere bande ka hun ikaccaa ga ka koy ibeeroo ga.

$$20 ; 0 ; 6 ; 19 ; 22 ; 20 ; 15 ; 13 ; 28 ; 8 ; 29 ; 24.$$

2. Hinnawey hanga-hangandi cere bande ka hun ibeeroo ga ka kaa ikaccaa ga :

$$16 ; 8 ; 10 ; 14 ; 26 ; 19 ; 25 ; 17 ; 29 ; 12 ; 27 ; 20 ; 7 ; 6 ; 8 ; 18 ; 10.$$

Denden

- Hinnawey hantum 1 ka koy 29.
- Biyey berandi m'i marga nda iwoy-woy, ma ngi hinnaa hantum.

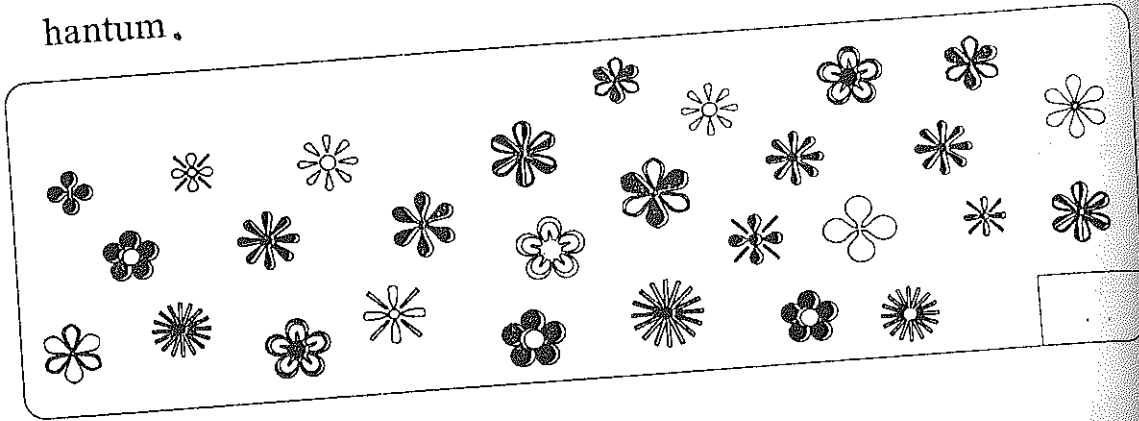

- Biyey berandi m'i timmandi.

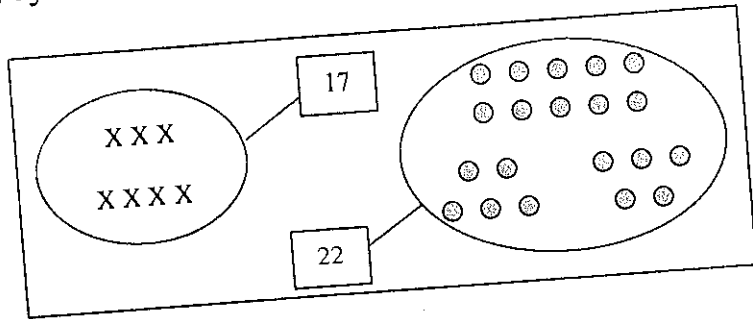

- Biyey berandi m'i marga nda iwoy-woy ma daaroo timmandi.

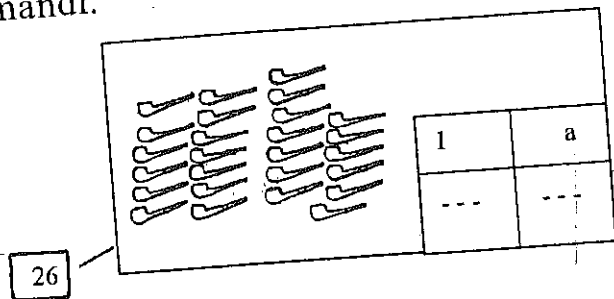

- Biyoo berandi ma hinnaa kaj goo daaroo ra biyey tee.

| | | |
|--|---|----|
| | 1 | a' |
| | 2 | 0 |

- Woo berandi m'a timmandi.

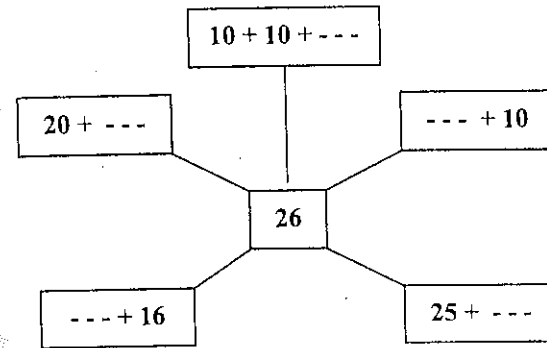

- Wey berandi ma tonton i ga.

a. 21, 21

waranka cindi foo

b. Daaroo berandi m'a timmandi.

| | | | |
|-----|---------------------|------------------------------|--------|
| 12 | | Iwoy boŋ - - nda affowey - - | --- |
| - - | | Iwoy boŋ - - nda affowey - - | 20 + 6 |
| - - | Waranka cindi yagga | Iwoy boŋ - - nda affowey - - | --- |
| - - | | Iwoy boŋ 2 nda affowey 3 | --- |
| 20 | | Iwoy boŋ - - nda affowey - - | --- |

8. Hinna foo kul hantum zuwoo kaŋ ga hima ra.

| |
|---------|
| 10 + 17 |
|---------|

| |
|---------|
| 15 + 14 |
|---------|

| |
|--------|
| 15 + 3 |
|--------|

| |
|---------|
| 16 + 13 |
|---------|

| |
|---------|
| 11 + 17 |
|---------|

| |
|--------|
| 20 + 7 |
|--------|

| | | |
|---------|-----|-----|
| 27 | 18 | 29 |
| 10 + 17 | --- | --- |
| --- | --- | --- |

9. a. Zuwoo tee m'a timmandi.

| | | | | | | | | | | | | | | | | | | | |
|----|----|----|----|--|--|--|--|--|--|--|--|--|--|--|--|--|--|--|--|
| 29 | 28 | 27 | 26 | | | | | | | | | | | | | | | | |
|----|----|----|----|--|--|--|--|--|--|--|--|--|--|--|--|--|--|--|--|

b. Wey tee ma tonton i ga.

28 ; 28 ;

 waranka cindi yaaha, _____

10. Wey berandi, m'i timmandi nda < , > wala =.

12 --- 9 ; 20 --- 10 + 10 ; 26 --- 21 ; 9 + 15 --- 24
 27 --- 22 ; 26 --- 12 + 4 ; 16 --- 7 + 9 ; 21 --- 23

Zuwey bee m'i timmandi.

| | | | | | | | | |
|---------------------|----|--|--|--|-------------------|--|--|----|
| | 20 | | | | 24 | | | 20 |
| | | | | | | | | |
| | | | | | | | | |
| | | | | | | | | 17 |
| Waranka cindi hinka | | | | | Waranka cindi guu | | | |

11. Iwoy boŋey nda affowey tee ma daaroo timmandi.

| Iwoyey | Affowey |
|--------|---------|
| | |

12. Hinnawey hanga-hangandi cere bande :

- a. ka hun ikaccaa ga ka koy ibeeroo ga ;
 - b. ka hun ibeeroo ga ka kaa ikaccaa ga.
- 16 ; 15 ; 20 ; 21 ; 29 ; 25 ; 19 ; 27 ; 22 ; 28 ; 24 ; 7 ;
 0 ; 3 ; 9 ; 12.

Caw : Misey kaŋ ra tontonyan ga tee 20 ka koy 29

aaasiha : Taaliboo ma hin :

- ka haya tee kaŋ ra mise kaŋ ga boŋ haw ga fahamandi ;
- ka duu sawandi kaŋ ga tenji nda misoo kaŋ alfagaa n'a noo ;
- ka duu furaroo zaaboo.

Goyjinawey : bundu-ize, tondi-ize.

Goyey

Goy jinaa : Alfagaa ma furaroo woo noo taalibey se.

Furari : Isaa goo nda feeji 8 nda haw 5. Marje ti adabbawey hinnaa ?

- Taalibey ma zaaboo ceeci, i ma adabbawey biyey tee, i m'i sasawandi, sanda : $8 + 5 = \dots$ wala $5 + 8 = \dots$
- Alfagaa ma zaaboo har kalimajaa ra.
« Isaa goo nda adabba 13 ».

Goy hinkantoo : Alfagaa ga willi goy jinaa ga nda furarey wey.
« Subbaahoo, Isaa na kalam 9 kurma. Woymaa n'a noo 3, marje ti kalamey hinnaa ? »

« Hamma goo nda wali-ize 7 za waloo mana sintin. A na wali-ize 8 gaa waloo ra. Marje ti Hamma waley hinnaa ? ».

Goy hinzantoo : **Furari** : Boro 4 goo looraa ra. Looraa yee ka boro 5 sanbu. Boro marje bara looraa ra ?

$$\dots + \dots = \dots$$

boro - - - bara looraa ra.

Goy taacantoo : **Furari** : Alfagaa ma nee taalibi foo kul ma kate bundu-ize 6. Aliyyu kate 4. Macin no Aliyyu ga hima k'a tee ?
Alfagaa ma nee taalibey ma goyoo zente ; i ma nga sawandoo tee, sanda : $4 + \dots = 6$; waati din i ma zaaboo har mee senni ra.

Goy guwantoo : Taalibey ma yee goy 4^{ntoo} ga nda furarey wey.

Furari : « Hima goo nda feeji 11, feeji marje no m'i timmandi 18. $11 + \dots = 18$

« Saafi na tamaati kokonda 8 hegay bi. Hõ zaaroo, a na itana fooyan hegay. A goo nda sohõ tamaati kokonda 11. Marje ti tamaatey kokondawey hinnaa hõ zaaroo ? ».

$$8 + \dots = 11$$

« Ir na hawru taasuu taasa 9 ra. Ir na hamiisa kaa taasayan ra. Taasawey kul cere ra ga too 14. Marje ti hamiisaa waney ? ».

$$9 + \dots = 14$$

« Saadu na huryaw 8 nda guuru sokolyan jisi taabaloo boŋ. Jinawey kul cere ra ga sawa nda 16. Marje ti guuru sokoley hinnaa ? ».

$$8 + \dots = 16$$

« Fanta na leemurba 15 day. I n'a noo affooyan yaada. Fanta leemurey ga too 17 sohõ. Leemur marje no a duu a yaada ? »

$$15 + \dots = 17.$$

oy idduwantoo : Biyey tee, ma daaraa filla, ma sawandoo timmandi

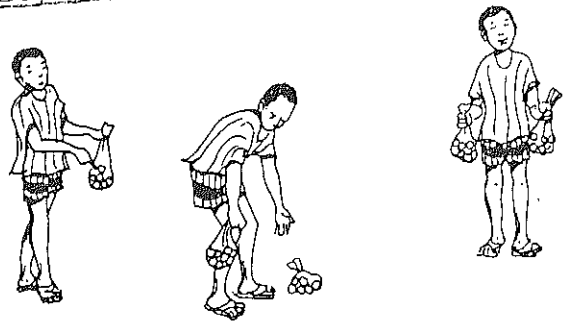

Goy iyyantoo : Biyey tee, ma daaraa filla, ma goyoo timmandi



Goy yaahantoo : Biyey tee, ma sawandoo timmandi.



Denden

1. Taaliboo tiiraa :

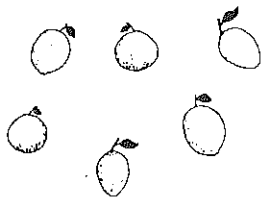

Furari : Muusa ga baa leemur-ize 10. A goo nda 6.
Leemur-izey kaɗ ga kuma biyey tee.

Woo timmandi --- + --- = ---

A cindi leemur-ize - - - - -

2. Taaliboo tiiraa : Biyey tee, ma daaraa filla, ma sawandoo timmandi.

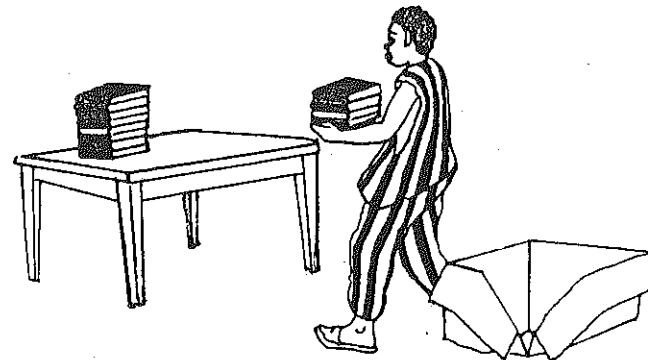

3. Furari : « Amadu goo nda bonbon 6. A ga baa nga ma duu bonbon 9. Marje no a g'a wiri ? ».

4. Taaliboo tiiraa : Biyey tee, ma zaabey hantum.



5. Taaliboo tiiraa : Biyey tee, ma sawandoo timmandi.

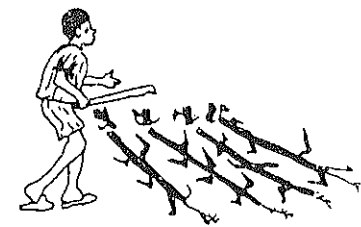
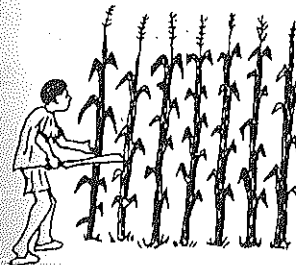

6. Taaliboo tiiraa : Biyey tee, ma sawandoo timmandi.

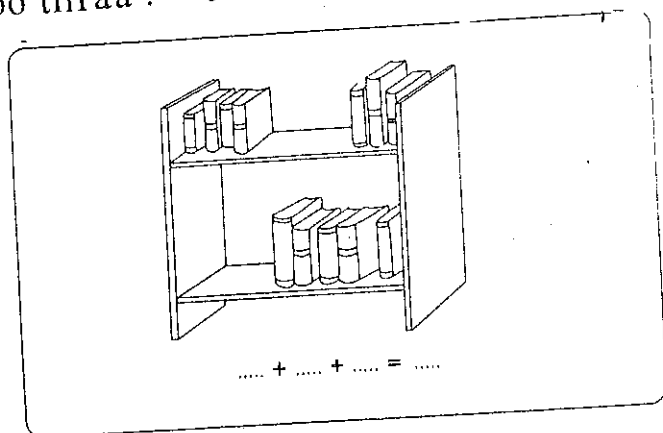

7. Taaliboo tiiraa : Biyey kaŋ ga kuma tee, ma sawandoo timmandi.

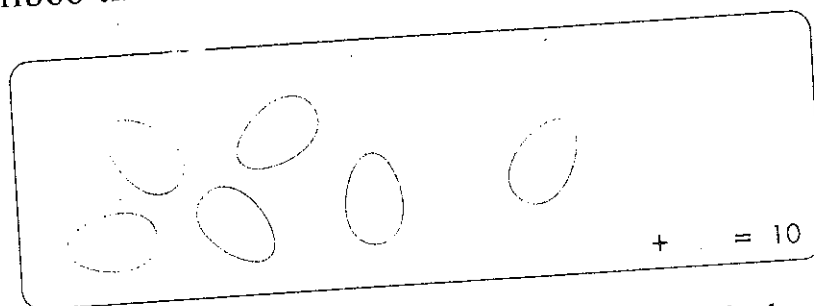

8. Furari : Fanta duu mangoro 3, leemurba 4 nda leemur-ize

5. Tuuri-izey kaŋ a duu ey biyey tee, ma sawandoo timmandi.

$$----- + ----- + ----- = -----$$

Fanta duu tuuri-ize.

9. Alfagaa ma sawandey wey noo. A ma nee taalibi foo kul m'i hantum sanda :

$$4 + 6 = -----$$

$$7 + ---- = 12$$

Daaraa filla kaŋ ga tenji nda sawandey wey affoo kul, ma sawandoo timmandi.

Caw : 30 hinnaa

Taasiha : Taaliboo ma hin :

- ka margari-ize hinnaa bay ;
- ka hinnawey caw, a m'i hantum kabu-ize nda harfu ra hala 30 ga ;
- ka iwoy boŋ nda affowey hinnaa bay, a ma zaaboo hantum ;
- ka hinna cebe nda jinay ;
- ka hinna kabu-izey dogey alkadaroo bay ;
- ka hinnawey hanga-hangandi cere ka sintin 0 ka koy 30 ;
- ka hinna cin, k'a fesu-fesu ;
- ka hinnawey durse ka sintin 1 ka koy 30 ;
- ka margari cin kaŋ ize hinnaa ga bayrandi.

Goyjinawey : tondi-ize, kalam, jinay kaŋ ga kabandi.

Goyey

Goy jinaa : Alfagaa ma nee taalibey ma margari tee kaŋ margari-izey hinnaa ga sawa nda 29. I ma yee ka margari tee kaŋ margari-ize foo goo a ra. I ma i tonton cere ga.

- Alfagaa ma 30 hantum walhabeeroo ga kabu-ize nda harfu ra ; a ma nee taalibey m'a berandi.

Goy hinkantoo : Alfagaa ma nee taalibey ma margarey kan i duu ey biyey tee.

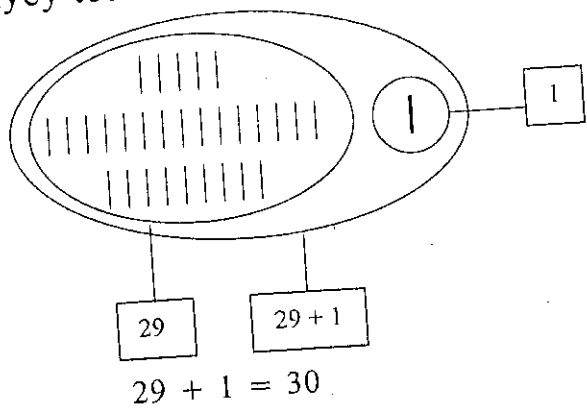

- Alfagaa ma nee i m'a hantum daaroo ra sanda

| Iwoyey | Affowey |
|--------|---------|
| 3 | 0 |

Goy hinzantoo : Alfagaa ma nee taalibey ma hinnawey deedandi.

0 ka koy 30.

- Alfagaa ma nee taalibey ma hinnawey cin, i m'i fesu-fesu

0 ka koy 30.

Goy taacantoo : Alfagaa ma nee taalibey ma hinnawey durse.

Goy guwantoo : Alfagaa ga taalibey noo margariyan kan margari-izey hinnaa si bisa 30. A ma nee taalibey m'i marga nda 10-10. A ma nee taalibey ma iwoy bojey nda affowey hinnaa bay. I ma zaaboo hantum.

Goy idduwantoo : Hinna goyjinawey tee, ngi hinnaa ma sawa nda hinnawey wey.

17 30 12 16 4 20 13

Goy iyyantoo : Alfagaa ma hinnawey 1 ka koy 30 ga, har, a ma nee taalibey ma iwoy bojey kabu-izey nda affowey waney cebe sanda : 27

2 mana ti kala iwoy bojey kabu-izoo ;

7 mana ti kala affowey kabu-izoo.

Goy yaahantoo : Alfagaa ma hinnayan noo taalibey se, a ma nee i ma margariyan tee kan margari-izey hinnaa ga sawa nda hinnawey kan nondi.

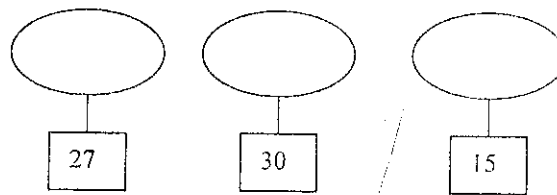

Denden

1. 30 hantum hala cee boobo, kabu-ize nda harfu ra (30 ; waranza).
2. Biyey berandi, ma margariyan tee nda 10-10 (iwoy-woy), ma hinnaa hantum.

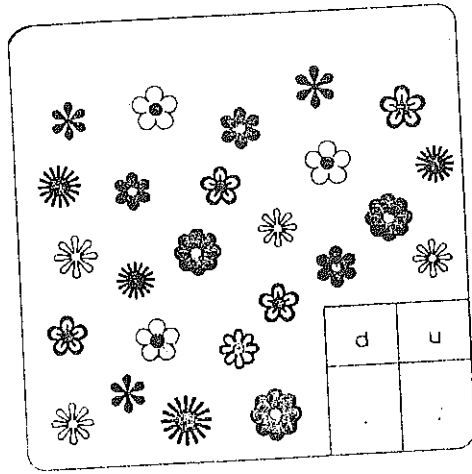

3. Biyey tee, ma tamaatey hinnaa hantum daaroo ra.

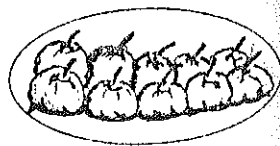
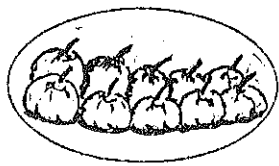

| Iwoyey | Affowey |
|--------|---------|
| --- | --- |

4. Daaroo berandi, m'a timmandi.

| | | |
|-----|----------------------------------|--------|
| 29 | Iwoy boj - - - - nda cindi - - - | ----- |
| --- | Iwoy boj - - - - nda cindi - - - | 10 + 8 |
| --- | Iwoy boj 2 nda cindi 7 | |
| 30 | Iwoy boj - - - - nda cindi - - - | |

5. Woo berandi m'a timmandi.

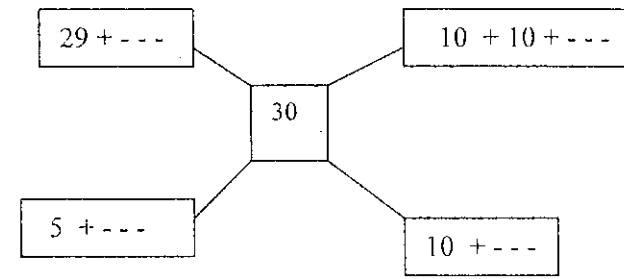

6. Woo berandi m'a timmandi nda < , > wala =.

| | | | |
|----|----|-----------------|----------------------|
| 22 | 22 | 29 - - - 20 + 9 | 20 + 10 - - - 25 + 5 |
| 30 | 29 | 24 - - - 17 | 29 + 1 - - - 30 |

7. Hinna wey hantum 1 ka koy 30, ma yee k'i hantum 30 ka kaa 1.

8. Hinna foo kul cebe nda hinna goyjinawey.

| | | | |
|----|----|----|----|
| 27 | 30 | 19 | 26 |
| 15 | 28 | 25 | 20 |

9. Hinna wey affoo kul hantum kabu-ize daari ra.

| | | | | |
|----|----|----|----|----|
| 13 | 30 | 24 | 22 | 11 |
|----|----|----|----|----|

10. Wey berandi, ma affoo kul jinawey biyey dam koloo ra.

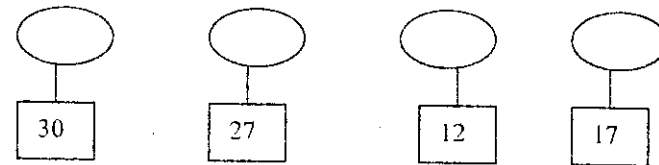

Filla : 0 ka koy 30 hinnawey

Alfagaa ma nee taalibey ma dendeney wey tee.

Denden

1. Biyey tee, ma margari foo kul dobandi nga hugu-izoo ga.

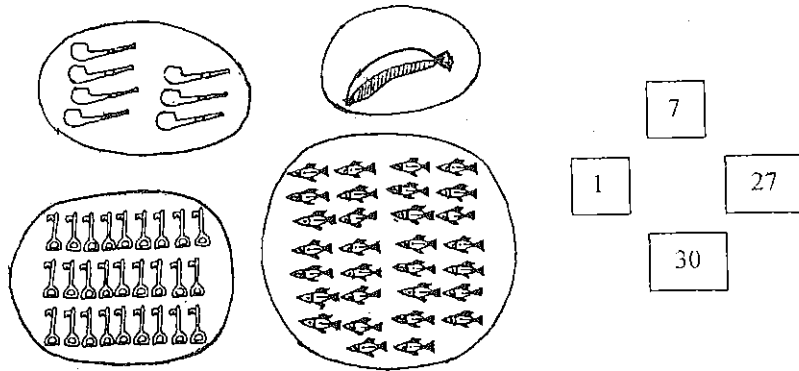

2. Biyey tee, ma hinnaa hantum hugu-izoo ra kaŋ goo biyoo cire.

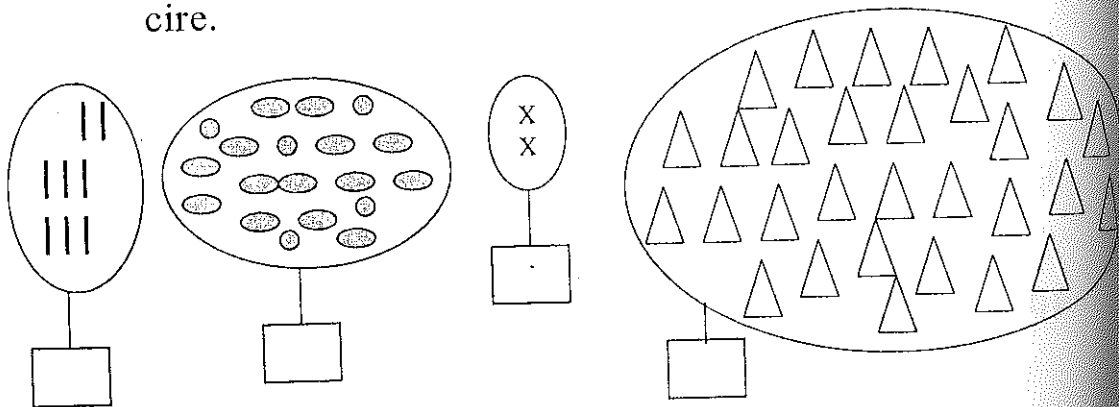

3. Biyey berandi, ma hinnaa caw kaŋ goo hugu-izoo ra, ma nga gunguley hinnaa tee margaroo gundoo ra.

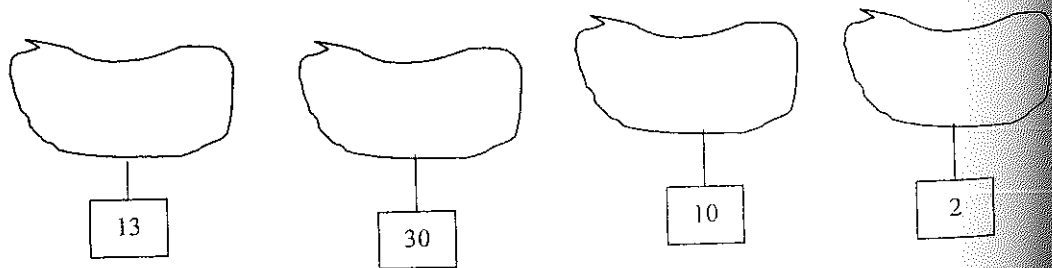

5. Woo berandi m'a timmandi.

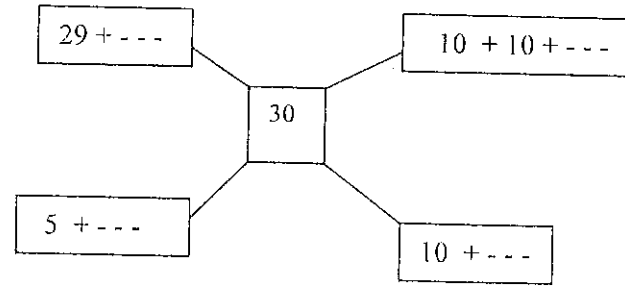

6. Woo berandi m'a timmandi nda < , > wala =.

| | | | |
|----|----|---------------|--------------------|
| 22 | 22 | 29 --- 20 + 9 | 20 + 10 --- 25 + 5 |
| 30 | 29 | 24 --- 17 | 29 + 1 --- 30 |

7. Hinnawey hantum 1 ka koy 30, ma yee k'i hantum 30 ka kaa 1.

8. Hinna foo kul cebe nda hinna goyjinawey.

| | | | |
|----|----|----|----|
| 27 | 30 | 19 | 26 |
| 15 | 28 | 25 | 20 |

9. Hinnawey wey affoo kul hantum kabu-ize daari ra.

| | | | | |
|----|----|----|----|----|
| 13 | 30 | 24 | 22 | 11 |
|----|----|----|----|----|

10. Wey berandi, ma affoo kul jinawey biyey dam koloo ra.

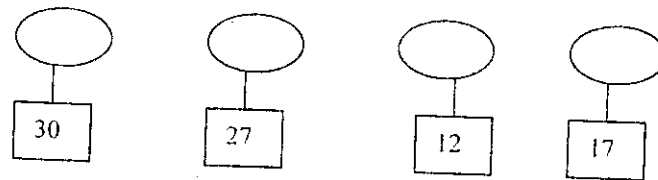

Filla : 0 ka koy 30 hinnawey

Alfagaa ma nee taalibey ma dendaney wey tee.

Denden

1. Biyey tee, ma margari foo kul dobandi nga hugu-izoo ga.

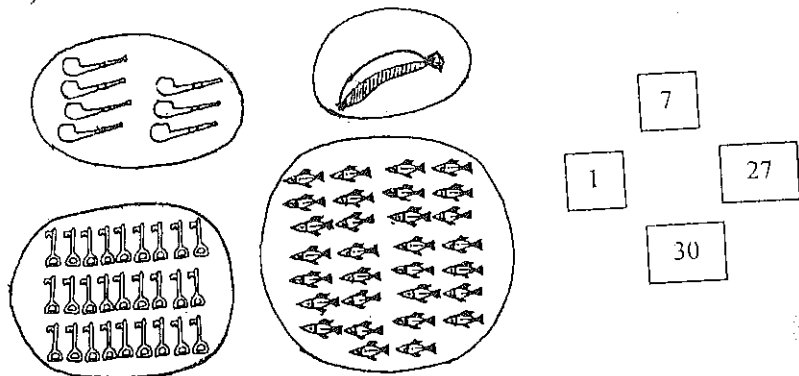

2. Biyey tee, ma hinnaa hantum hugu-izoo ra kanj goo biyoo cire.

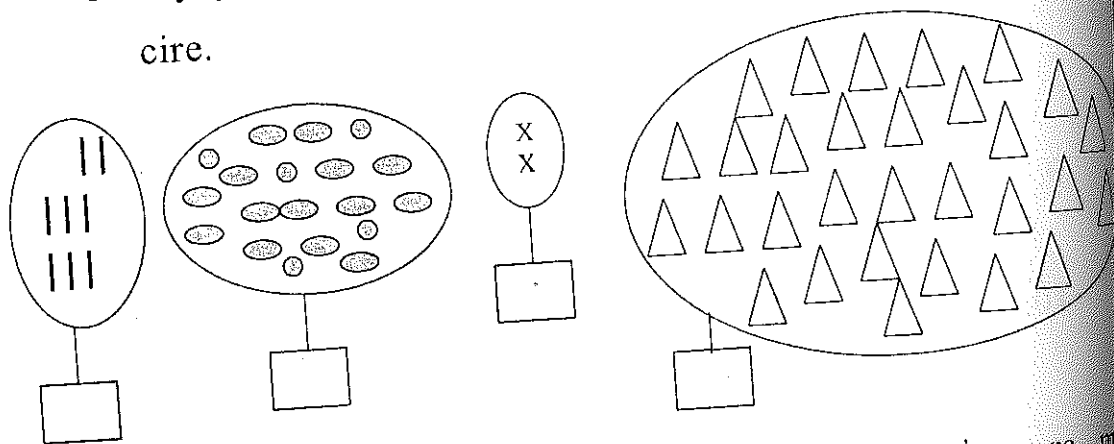

3. Biyey berandi, ma hinnaa caw kanj goo hugu-izoo ra, nga gunguley hinnaa tee margaroo gundoo ra.

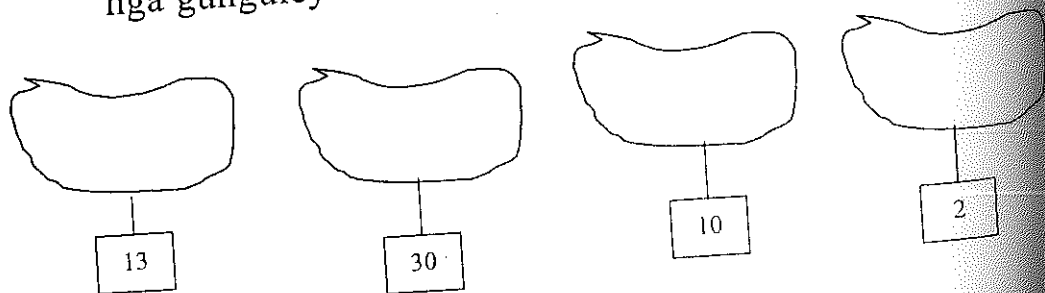

4. Hinnawey hantum 1 ka koy 30.

5. Biyoo tee, ma timmandi.

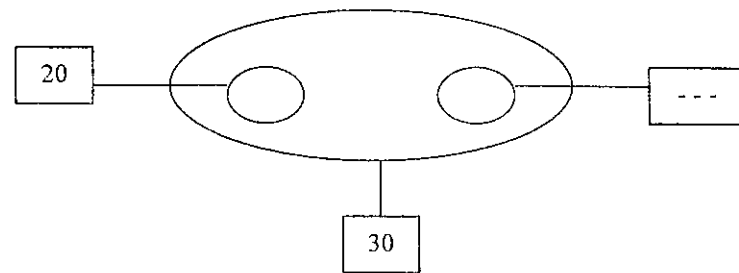

6. Hinnawey hantum nda tammaasaa kanj ga hima :

< ; > ; =

27 - - - 30

29 - - - 17

24 - - - 12 + 12

19 - - - 20

4 - - - 28

12 - - - 7 + 5

7. Margari bii tee kanj izey hinnaa ga sawa nda hinnaa kanj goo daaroo ra.

| Iwoyey | Affowey |
|--------|---------|
| 1 | 4 |

| Iwoyey | Affowey |
|--------|---------|
| 2 | 9 |

8. Hinnawey wey cebe nda hinnabayray goyjinawey

| | | | | |
|---|----|----|----|----|
| 9 | 19 | 30 | 24 | 14 |
| | 28 | 30 | | 4 |

9. Hinnawey wey affoo kul hantum hinnabayray daaroo ra

| | | |
|----|----|----|
| 28 | 30 | 16 |
| 4 | 12 | 24 |

10. Wey hantum kabu-ize ra.

Waranka

Waranza

Iwoy cindi iddu

Waranka cindi taaci

Iwoy cindi yaaha

Waranka cindi iddu.

11. Hinnawey wey hantum, m'i fesu-fesu.

13 ; 24 ; 30 ; 17 ; 28.

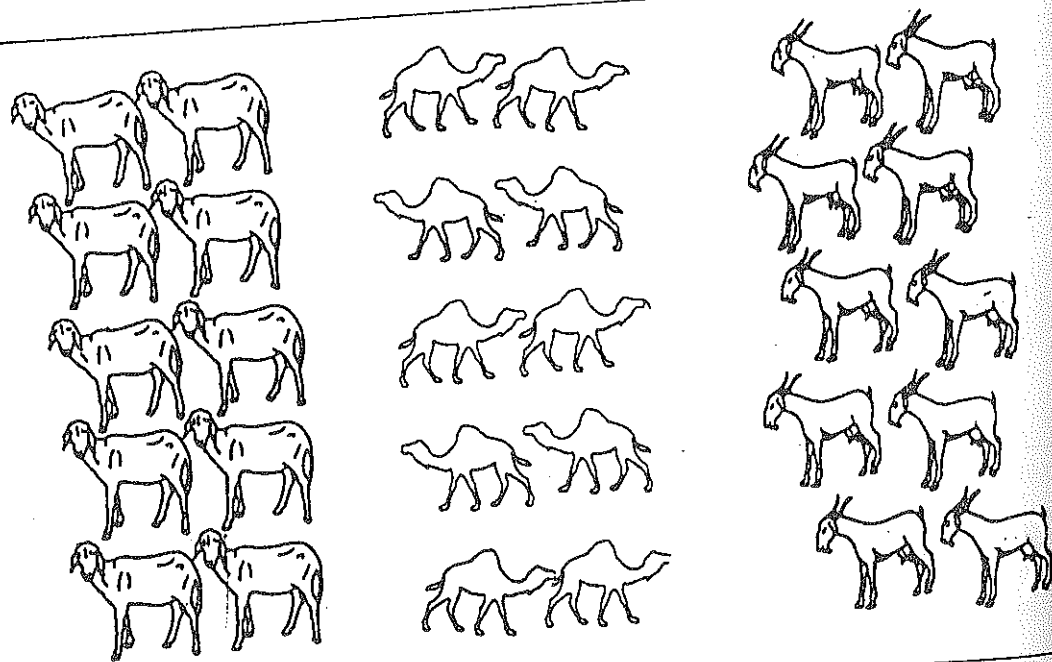

Caw : Kaayan maana

Taasiha : Taaliboo ma hin :

- ka faham mise booboyaŋ se kaŋ ra kaayan goo ;
- ka duu hinna hinka kaayan ra hinnaa kaŋ ga kuma ;
- ka faham mise booboyaŋ se kaŋ ra i ga goy nda kaayan tammaasaa (-).

Goyjinawey : Tondi-ize, bundu-ize, taalibi-izeyaŋ, tiirayaŋ.

Goyey

Goy jinaa : Alfagaa ma taalibiyaŋ 6 kayandi cerey jine, a m'i hãa nda ngi hinnaa.

- Alfagaa ma nee taalibey se, i ma boro 11 kuray tee kaŋ ra 6 goo nda darbay kaaray. A m'i hãa nda takaa kaŋ nda goyoo ga hima ka tee.
- Alfagaa ma nee taalibey ma zaaboo ceeci i ma takaa filla kaŋ nda i n'a tee. A ma nee taalibey ma goyoo zente, i ma kaayanoo hantum sanda : $6 + \text{----} = 11$.

Denden

Taalibi 10 nda walha 6 goo cawhugoo ra. Taalibi marje ka sii nda walha ?

Goy hinkantoo : Taalibi 19 goo cawhugoo ra. Taalibi 8 kul ti woy. Marje ti arey hinnaa ?

Taalibey ma zaaboo ceeci, i ma takaa cebe kaŋ nda i duu a. I ma goyoo zente. A ga sawa nda :

$$8 + \text{---} = 19$$

$$\text{wala } \text{---} + 8 = 19$$

Denden

1. Biyey timmandi, ma sasawandoo tee.

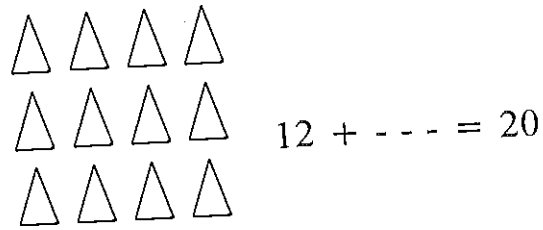
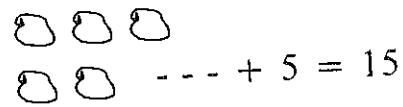

Goy hinzantoo : Sallay na lefe 15 kay. Faadi na 8 kay. Lefe marje nda Sallay ga bisa Faadi ?
Taalibey ma boro hinkaa lefawey deedandi. I ma zaaboo tee, ma takaa cebe kan nda i duu a.

Denden

Daabirjey hinnaa hantum kan ga kuma.

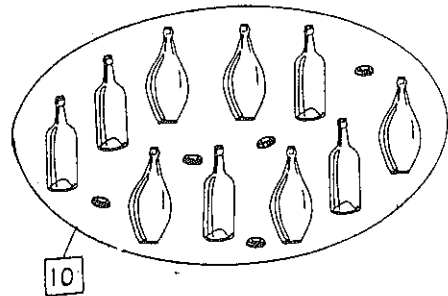

Goy taacantoo : Alfagaa ma tondi-ize 12 noo taalibi foo se. A ma nee taaliboo ma 5 noo cere foo se. Tondi-ize marje no ma cindi a kone ?

- Alfagaa ma nee taalibey ma zaaboo ceeci i ma takaa har kan nda i duu a.

Tondi-ize 7 no ma cindi, i ga hantum nda $11 - 5 = 7$.

Taalibey m'a hantum i m'a caw.

Denden

Taalibi 18 bara cawhugoo ra subbaahoo. Waatoo kan i fatta ka hooray, 5 yee ngi hugey do.

Taalibi-ize marje no ka cindi cawhugoo ra ?

Alfagaa ma nee taalibey ma hinnaa kan cindi ceeci nda kaayan tammaasaa « - ».

Denden

1. Laasaabu, ma sasawandoo timmandi.

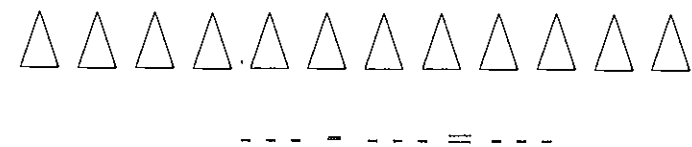
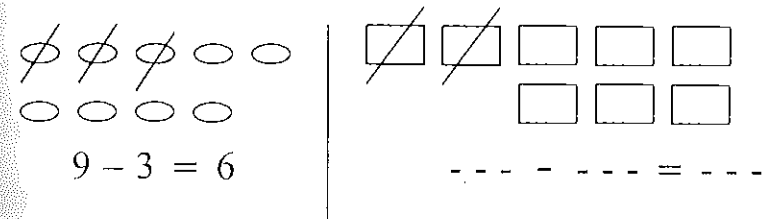

2. Zeeri dam biyey ga ka duu sasawandoo.

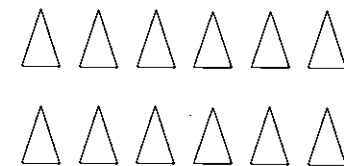

$$12 - 8 = 4$$

3. Kabey wey timmandi.

$$17 - 5 = ---$$

$$14 - 2 = ---$$

$$19 - 7 = ---$$

$$12 - 1 = ---$$

$$15 - 3 = ---$$

$$13 - 3 = ---$$

$$26 - 4 = ---$$

$$16 - 3 = ---$$

4. Kabu ka yee banda ka duu zaaboo zuwoo ra.

| | | | | | | | | | | | | | | | | | | | |
|---|---|---|---|---|---|---|---|---|----|----|----|----|----|----|----|----|----|----|----|
| 1 | 2 | 3 | 4 | 5 | 6 | 7 | 8 | 9 | 10 | 11 | 12 | 13 | 14 | 15 | 16 | 17 | 18 | 19 | 20 |
|---|---|---|---|---|---|---|---|---|----|----|----|----|----|----|----|----|----|----|----|

Sanda : $13 - 3 = 10$

5. Wey hantum, m'i timmandi nda « + » ; « - ».

$2 + 7 = 9$

$12 - 5 = 7$ $18 - 6 = 12$

$20 - 10 = 10$ $20 - 5 = 15$

$8 - 6 = 2$ $30 - 10 = 20$

$10 - 3 = 7$ $10 - 5 = 5$

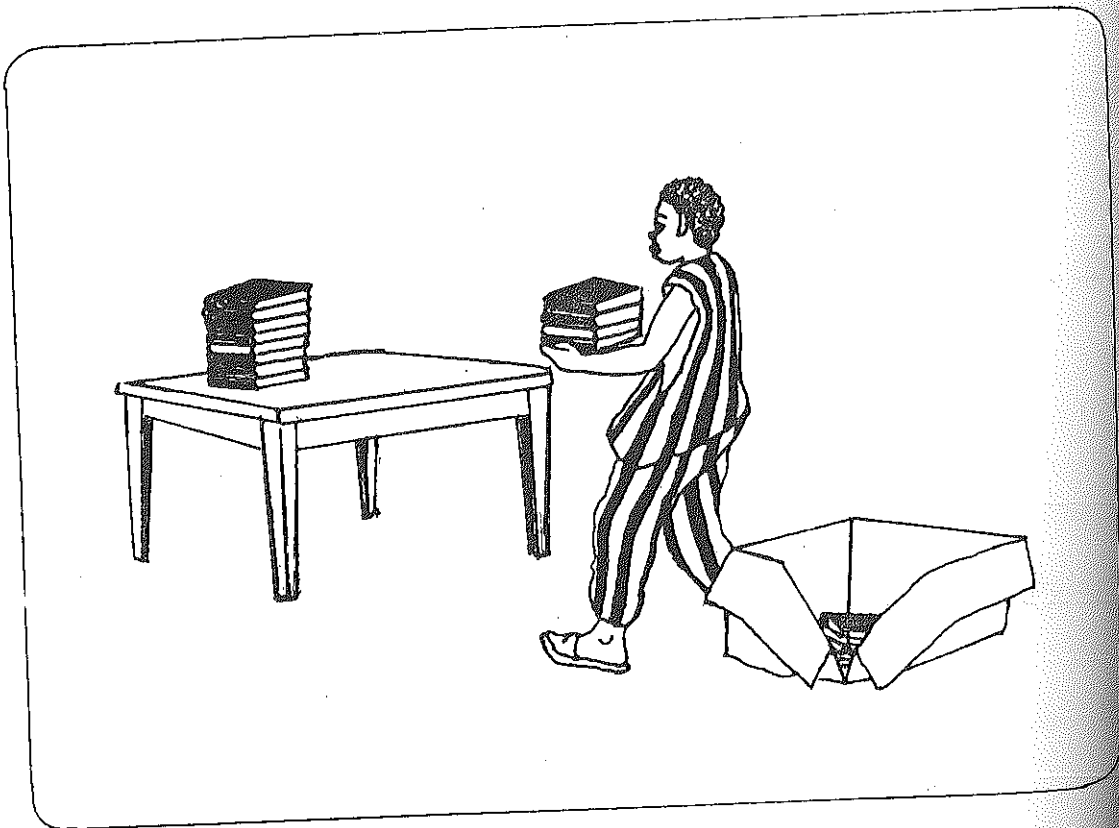

Caw : 30 ka koy 39 hinnawey

Taasiha : Taaliboo ma hin :

- ka margari-izey hinnaa bay ;
- ka 30 ka koy 39 hinnawey cin ;
- ka 30 ka koy 39 hinnawey caw, a m'i hantum kabu-ize nda harfu ra ;
- ka 30 ka koy 39 hinnawey hanga-hangandi cere ;
- ka 30 ka koy 39 hinnawey fesu-fesu.

Goyjinawey : Tondi-ize, bundu-ize.

Goyey

Goy jinaa : Alfagaa ma nee taalibi foo kul ma iwoy boŋ 2 nda bundu-ize yagga zaa. I ma bundu-ize foo tonton yaggaa ga. I m'i haw. I ma hinnaa hantum nda kabu-ize nda harfu ra.

Goy hinkantoo : Alfagaa ma nee taalibi foo kul ma iwoy boŋ 3 zaa. I ma bundu-ize foo zaa, i m'a tonton iwoy boŋ 3 ga ; i m'i kabu. (Iwoy boŋ 3 nda 1). I ma iwoy boŋ 3 zeeri i m'affoo tonton i ga, i ma hinnaa zeeri kaŋ nda i ga sawa : i ma affoo kul hinnaa hantum a cire.

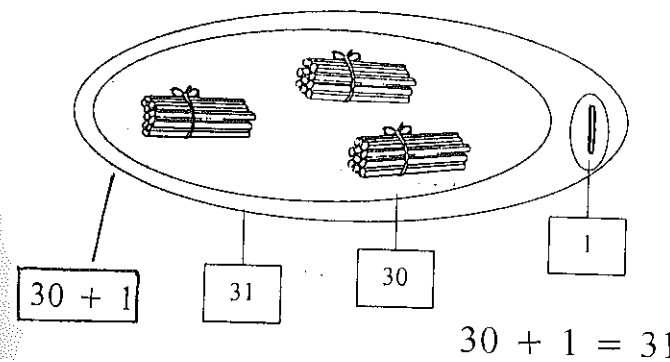

Alfagaa ma 31 har, a m'a hantum nda kabu-ize nda harfu.

Taalibey ma 31 fay iwoy boŋ 3 nda 1



Alfagaa ma nee taalibey ma goyoo tee nda takaa woo da, za 31 ka koy 39 ga.

Goy hinzantoo: Alfagaa ma 31 nda 13 hantum walhabeeroo ga.

Alfagaa ma iwoy boŋey wanoo har, a ma affowey wanoo har.

Taalibey ma hinnaa hantum kabu-ize nda harfu ra.

Laasaabu: iwoy boŋ hinza nda ihinka: 32; waranza cindi hinka.

Alfagaa ma 31 fesu-fesu sanda: $30 + 1 = 31$.

Taalibey m'a hantum, i ma goyoo filla nda takaa woo, za 30 ka koy 39 hinnawey ga.

Goy taacantoo: Alfagaa ma nee taalibey ma hinnawey deedandi: sanda 32 nda 35. I kul goo nda iwoy boŋ hinna follokaa amma affowey hinnaa ga waani*: $35 > 32$; $32 < 35$.

Sanda: 31 nda 13: Ibeeroo ti woo kaŋ iwoy boŋoo ga beeri: $31 > 13$; $13 < 31$.

Denden

1. Daaroo tee m'a timmandi.

| | |
|----|-------------------|
| 21 | Waranka cindi foo |
| 34 | |
| 36 | |
| 18 | |
| 32 | |
| 39 | |
| 25 | |

* Ka waani: ka fay.

2. Daaroo woo tee k'a timmandi.

| | | |
|----|---------------------|----------|
| 32 | Waranza cindi hinka | $30 + 2$ |
| 35 | | |
| 37 | | |
| 38 | | |
| 33 | | |

3. Hinnawey hanga-hangandi cere bande:

21, 36, 24, 33, 20, 35, 37, 28, 30, 29, 39, 22, 23, 34, 25, 31, 32, 27, 38.

4. Hinnawey tee fesu-fesu hinka: sanda: $36 = 30 + 6$

$27 = \dots + \dots$; $32 = \dots$; $37 = \dots$; $39 = \dots$; $34 = \dots$

5. Daaroo tee m'a timmandi:

| | | |
|------|-----------------------------|----------|
| 31 | Iwoy boŋ .. nda affowey ... | |
| | Iwoy boŋ .. nda affowey ... | $30 + 5$ |
| | | $30 + 7$ |
| 39 | Iwoy boŋ .. nda affowey ... | |

6. Hinnawey wey hantum: ma <wala> wala = dam gamey ra.

28 ... 22; 32 ... 29; 24 ... 34; 29 ... 20 + 9

27 ... 33; 20 + 10 ... 31; 30 ... 30 + 4

20 + 10 ... 33; 3 + 4 ... 30.

7. Daaroo tee, ma hinnaa hantum kaŋ ga kaa jine nda woo kaŋ ga kaa banda.

| | | |
|----|----|----|
| 33 | 34 | 35 |
| | 37 | |
| | 15 | |
| | 21 | |

Caw : Kaayan almaanaa nda teeyanoo

Taasiha : Taaliboo ma hin :

- ka kaayan tee nda goyjinawey ;
- ka kaayan kabu dumey suka, k'i tee.

Goyjinawey : bundu-ize nda tondi-ize.

Bonkabu : 2 kaayanoo sanda $16 - 2 = 14$

Alfagaa ma kaayaney wey tee « Lamartinière » fonda bande
 $18 - 2 = ?$

Goyey

Goy jinaa : Alfagaa ma nee taalibey ma bonhawoo tee :

Bonhaw : Cawhugu foo goo nda taalibi 38, taalibi 24 mana
 too jina. Taalibi marje ka kaa ?

- Alfagaa ma naŋ taalibey ma ceeci nda ngi bonŋ lakkaley,
 i ma takaa fahamandi kaŋ nda i n'a tee.
- Alfagaa ma kate i ma kabu kabiilaa woo tee.
 $38 - 24 = \text{-----}$
- Taalibey ma hinna jinaa cebe nda bundu-ize. Iwoybonŋ 3
 nda bundu-ize 8 ; i ma bundu-ize iwoy bonŋ 2 nda bundu-
 ize 4 kaa ; i ma duu hinnaa kaŋ ga cindi : bundu-ize
 iwoybonŋ 1 nda bundu-ize taaci.
- 1 ma hinnaa kaŋ i duu a hantum kabu dumaroo jine.

Goy hinkantoo : Alfagaa ma nee taalibey ma goyoo kaŋ
 n'a tee beene biyoo tee.

1. Kabey suka, m'i tee.

$$39 - 26 ; 34 - 21 ; 37 - 35 ; 38 - 12 ; 35 - 24 ; 32 - 21.$$

2. Kabey wey tee.

$$35 - 5 = \text{-----}$$

$$33 - 13 = \text{-----}$$

$$35 - 25 = \text{-----}$$

$$30 - 20 = \text{-----}$$

$$32 - 12 = \text{-----}$$

3. Kabey suka, m'i tee.

$$38 - 27 ; 35 - 32 ; 37 - 33 ; 39 - 21 ; 34 - 22.$$

4. Kabey wey tee.

| | | | | | |
|------|------|------|------|------|------|
| 35 | 34 | 36 | 37 | 35 | 39 |
| - 33 | - 24 | - 16 | - 23 | - 23 | - 15 |
| = | = | = | = | = | = |

5. Dumma feejeey ti bonŋ 38 ; wircoo kaŋ huru i ra na bonŋ 12
 wii.

Feeji bonŋ marje ka cindi Dumma se ?

6. Faati goo nda k 37, a na k 5 garbay day.

Kaatibi marje ka cindi Faati se ?

Goy hinzantoo : Alfagaa ma kaboo suka hinnawey daaroo ra.

| Iwoyey | Affowey |
|--------|---------|
| 3 | 8 |
| 2 | 4 |
| 1 | 4 |

Goy taacantoo : Alfagaa ma kabu foo duma bila daaroo taalibey ma zaaboo ceeci.

Goy guwantoo : Alfagaa ma bonhaw tanayan tee kan ga hima nda ijinaa ; taalibey ma hanga fonda follokaa bande ka duu zaaboo.

Denden

1. Kabey wey tee.

$$\begin{array}{r} 35 \\ - 25 \\ \hline \end{array} \quad \begin{array}{r} 38 \\ - 16 \\ \hline \end{array} \quad \begin{array}{r} 39 \\ - 25 \\ \hline \end{array} \quad \begin{array}{r} 34 \\ - 31 \\ \hline \end{array} \quad \begin{array}{r} 37 \\ - 3 \\ \hline \end{array} \quad \begin{array}{r} 36 \\ - 11 \\ \hline \end{array}$$

2. Kabey wey suka m'i tee.

$$37 - 17 ; 39 - 27 ; 22 - 21.$$

3. Mahammadu na daasu 33 dam yooboo ra. Daasu 12 neerandi. Daasu marje ka cindi Mahammadu se kan mana neere ?

4. Daaraa woo filla, m'a timmandi.

$$\dots - \dots =$$



Caw : 40 hinnaa

Taasiha : Taaliboo ma hin :

- ka margari-izey hinnaa bay ;
- ka margari cin kan izey ga sawa nda 40 ;
- ka 40 caw k'a hantum nda kabu-ize nda harfu ;
- ka 40 cin wala k'a fesu-fesu.

Goyjinawey : bundu-ize, tondi, hkh.

Bonkabu : Alfagaa ga iwoy bonj har nda affoo-foo, taaliboo g'i hantum : 10 ; 20 ; 30.

Goyey

Goy jinaa : Alfagaa ma nee taalibey ma bundu 39 zaa.

I m'i kanandi nda iwoy-woy. A m'i haa wala iwoy bonj marje no i duu. (iwoy bonj hinza). Marje ka cindi ? (bundu-ize yagga). I kul ti cere ra marje ? (39). I ma bundu-ize foo tonton i ga. I kul ti cere ra marje ? (Taaliboo g'i kabu ; i ti iwoy bonj foo). Iwoy bonj foo kan tonton iwoy bonj hinza ga sawa nda iwoy bonj taaci).

Goy hinkantoo : Alfagaa ma nee taalibey ma ngi walhawey zaa. I ma iwoy bonj hinza tee. I ma bundu-ize yagga tee jerey ga. I ma affoo tonton i ga. I ma hinnaa kan nda i ga sawa tee : iwoy bonj taaci.

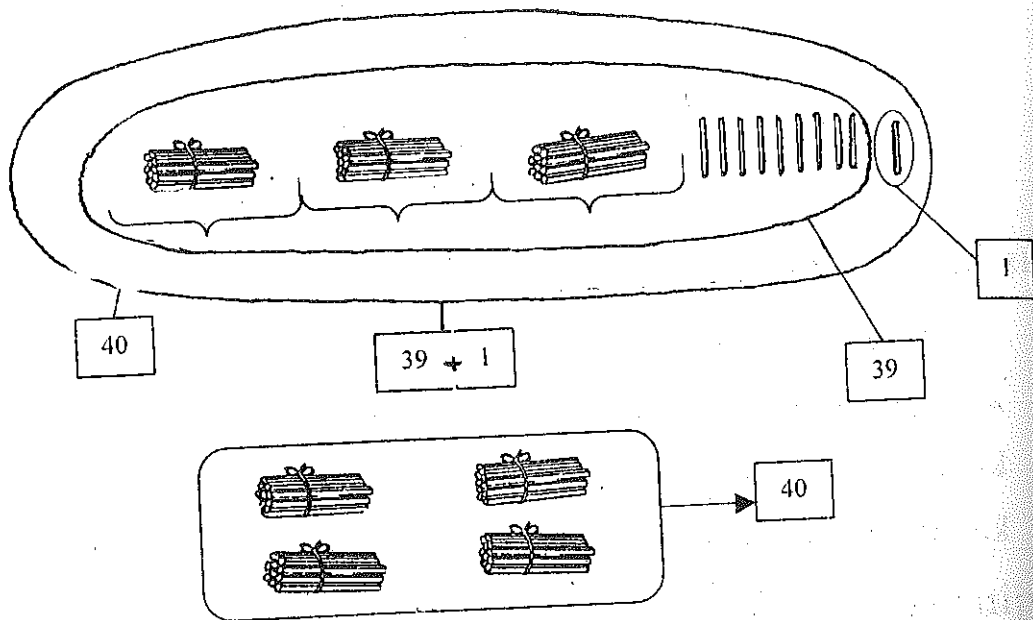

N.B. : Alfagaa ga goy follokaa tee walhabeeroo ga.

Goy hinzantoo : Alfagaa ma nee taalibey se i ma iwoy hinza nda bundu-ize yagga hinnaa hantum i cire. I ma affoo hinnaa hantum bundu-ize foo a cire. Alfagaa ma woytaaci (40) hantum iwoy boŋ taaci cire. Taalibey m'a hantum iwoy boŋ taacaa cire.

Goy taacantoo : Alfagaa ma goyoo filla nda tondi-ize biyey.

Goy igguwantoo : Alfagaa ma nee iwoyboŋ taaci « woytaaci » (40). Taalibey m'a har a bande. Alfagaa ma woytaaci hantum nda kabu-ize ; taalibey mo m'a hantum nda kabu-ize.

Goy idduwantoo : Alfagaa ma woytaaci hantum nda harfu ; taalibey mo m'a hantum nda harfu.

Goy iyyantoo : Taalibey ma daaroo tee. Alfagaa m'i hãa wala marje ma huru affowey sorraa ra. (0) I ma yaada hantum nda kabu-ize affowey sorraa ra. A ma yee k'i hãa wala marje ma huru iwoyey sorraa ; (4) i ma itaaci hantum iwoyey sorraa ra. Taalibey ma 40 hantum daaroo woo ra.

| Iwoyey | Affowey |
|--------|---------|
| 4 | 0 |

Goy yaahantoo : Alfagaa ma nee taalibey ma woytaaci fesu-fesu : (hinna 2, wala 5, wala 6).

$$40 = 20 + 20$$

$$40 = 8 + 8 + 8 + 8 + 8$$

$$40 = 6 + 9 + 5 + 7 + 8 + 5$$

$$40 = 5 + 5 + 5 + 5 + 5 + 5 + 5 + 5$$

Goy yaggantoo : Alfagaa ga taalibey hãa nda margarey kaŋ ga huru cere ga ka tee 40.

$$10 + 11 + 8 + 4 + 7 = 40$$

$$25 + 15 = 40$$

$$18 + 3 + 19 = 40$$

$$8 + 20 + 10 + 2 = 40$$

Denden

1. 40 hantum daaroo ra.

| Iwoyey | Affowey |
|--------|---------|
| | |

2. Margarey wey timmandi 40.

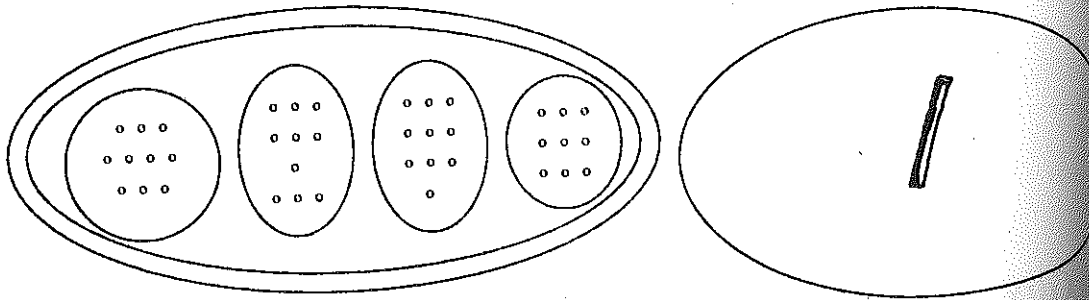

3. 40 hantum nda harfu.

4. 40 fesu-fesu margari 3.

5. Margari 6 tee kaɗ ga tonton cere ga ka sawa nda 40.

6. Fesu-fesey wey timmandi.

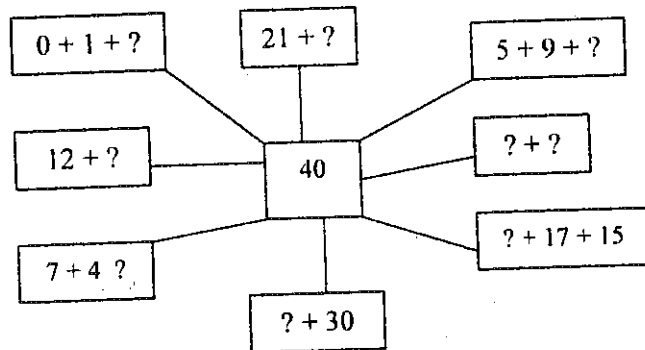

7. Hinnawey hanga-hangandi cere 0 ka koy 40.

Caw : Kaayan bila lanbari

Taasiha : Taaliboo ma hin :

- ka kaayan bila lanbari tee nda goyjinawey ;
- ka kaayan kaɗ sii nda lanbari kabu dumey suka, k'i tee.

Goyjinawey : Bundu-ize, tondi-ize.

Goyey

Goy jinaa : Alfagaa ma boɗhawoo woo noo taalibey se, i m'a tee : Amadu nda woymaa goo nda teenay 39. Amadu goo nda 23. Marje ti woymaa waney hinnaa ?

Alfagaa ma naɗ taalibey ma ceeci nda ngi boɗ, i ma takaa fahamandi kaɗ nda i n'a tee. Alfagaa ma kabu kabiilaa woo

$$\text{tee : } 23 + \dots = 39$$

23

+ ..

= 39

Alfagaa ma kaboo suka walhabeeroo ga. A ma taalibey haa, wala marje ma tonton 3 ga a ma tee 9 (6). Alfagaa ma taalibi foo sanba a ma 6 hantum 3 cire. A ma filla ka taalibey haa wala marje ma tonton 2 ga a ma tee 3 (1). Taalibi foo ma koy a hantum 2 cire. I ma filla ka kaa kaayanoo ga. Alfagaa ma kate taalibey ma kabu kabiilaa woo tee : $39 - 23 =$

Taalibey ma hinna jinaa cebe nda bundu-ize woy boɗ 3 nda bundu-ize 9 ; i ma bundu-ize iwoy boɗ 2 nda bundu-ize 3 kaa ka duu hinnaa kaɗ ga cindi : bundu-ize woy boɗ 1 nda bundu-ize 6 ; i m'a hantum kabu dumaroo jine.

Goy hinkantoo : Alfagaa ma 39 hinnaa tee walhabeeroo ga
nda takaa woo :

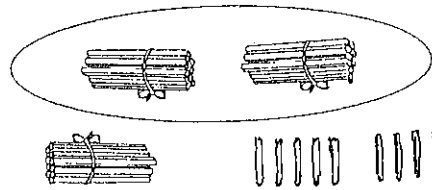

Hinnaa kañ hun ma koli, bundu-ize iwoy boñ 1 nda bundu-ize
6 ma cindi.

Goy hinzantoo : Alfagaa ma kaboo suka walhabeeroo ga.

39 - affowey sorraa ra : Laasaabu : 9 kañ ra 3 hun,
- 23 wala 3 kañ hun 9 ra, marje ma cindi ? « 6 ma cindi,
= m'a hantum affowey cire ».

- Iwoy boñey sorraa ra laasaabu : « 3 kañ ra 2 hun wala 2
kañ hun 3 ra, marje ma cindi ? » ; affoo ma cindi, m'a
hantum iwoy boñey cire ; ma hinnaa kañ ni duu a caw.

Goy taacantoo : Alfagaa ma boñhaw tanayan tee kañ ga
hima nda ijinaa ; taalibey ma hanga fondo follokaa bande ka
duu zaaboo.

Denden

1. Kabey wey tee.

| | | | | | |
|------|------|------|------|------|------|
| 36 | 29 | 38 | 37 | 33 | 35 |
| - 24 | - 16 | - 35 | - 34 | - 32 | - 13 |
| = | = | = | = | = | = |

2. Kabey wey suka m'i tee.

38-17 = ; 37-32 = ; 28-17 = ; 33-23 = ; 34-22 = ; 39-35 = ;

36-34 = ; 35-32 = ; 38-36 = .

3. Laasaabu takaa kañ nda kaayaney ga tee sanda :

| | | |
|-----|------|-----------------------|
| 34 | 36 | |
| - 2 | - 34 | m'i guna ka wey tee : |
| 32 | 2 | |

34 - 32 ; 39 - 37 ; 38 - 36.

4. Kabey wey tee.

35 - 5 = - - - -

33 - 22 = - - - -

35 - 24 = - - - -

30 - 20 = - - - -

32 - 21 = - - - -

5. Boñhaw : Agaali na takula 37 tee. A na 23 neere. Takula
marje ka cindi Agaali se ?

- Muusa koy nda k 35 yooboo ra. A na jinayyan day. K 23
ka cindi a se. Marje no a na jinawey day ?

- Alman boñ 19 ka ziji hondoo ra. Alaasar 12 ka jaaje.
Marje no ka mana kaa ?

Caw : 40 ka koy 49 hinnawey

Taasiha : Taaliboo ma hin :

- ka margari-izey hinnaa bay ;
- ka 40 ka koy 49 hinnawey cin ;
- ka 40 ka koy 49 hinnawey caw, a m'i hantum kabu-ize nda harfu ra ;
- ka 40 ka koy 49 hinnawey hanga-hangandi ;
- ka 40 ka koy 49 fesu-fesu ;

Goyjinawey : Tondi-ize, bundu-ize nda hkh.

Goyey :

Goy jinaa : Alfagaa ma nee taabal foo kul taalibey ma iwoy boŋ hinza nda bundu-ize yagga zaa ; i ma bundu-ize foo tonton yaggaa ga ; i m'i haw, i ma hinnaa kaŋ i duu a hantum nda kabu-ize, i m'a hantum nda harfu.

Goy hinkantoo : Alfagaa ma nee taabal foo kul taalibey ma iwoy taaci zaa, i ma bundu-ize foo zaa, i m'a tonton iwoy boŋ taaci ga ; i m'i kabu. (iwoy boŋ 4 nda 1) i ma iwoy boŋ taaci zeeri i ma affoo tonton i ga, i ma hinnaa zeeri kaŋ nda i ga sawa, i ma affoo kul hinnaa hantum a cire.

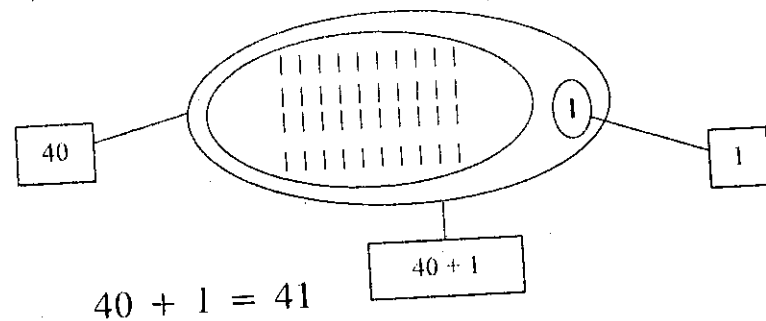

Alfagaa ma 41 har, a m'a hantum nda kabu-ize nda harfu.

Taalibey ma 41 fay iwoy boŋ taaci nda 1.

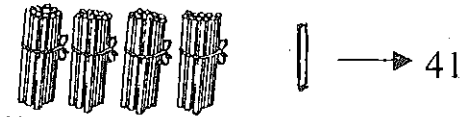

Alfagaa ma nee taalibey ma goyoo tee nda takaa woo da 41 ka koy 49 ga.

Goy hinzantoo : Alfagaa ma 41 nda 14 hantum walhabeeroo ga. A ma nee : taabal foo kul taalibzey ma :

- hinnawey kanandi nda goyjinawey ;
- i ma hinnaa foo kul iwoy boŋey nda affowey cebe ;
- taalibey ma kabu ize foo kul dogoo bay 40 ka koy 49 ra.
- Alfagaa ga iwoy boŋey wanoo har, a ma affowey wanoo har taalibey ma hinnaa hantum nda kabu-ize, i ma filla k'a hantum nda harfu.

Laasaabu : iwoy boŋ taaci nda ihinka : 42, woytaaci cindi hinka.

Alfagaa ma woytaaci cindi foo fesu-fesu sanda : $40 + 1 = 41$.

Taalibey m'a hantum nda $40 + 1 = 41$. A ma goyoo filla nda takaa woo da 40 ka koy 49 ga.

Goy taacantoo : Alfagaa ma nee taalibey ma hinnawey deedandi : sanda 42 nda 45 kul goo nda iwoy boŋ folloku amma affowey hinnaa ga waani. I kul ibeeroo ti woo kaŋ affowey ga beeri $45 > 42$ wala $42 < 45$.

Sanda 41 nda 14. I kul ibeeroo ti woo kaŋ iwoy boŋoo ga beeri : $41 > 14$ wala $14 < 41$.

Denden

1. Daaroo tee m'a timmandi.

| | | |
|-------|----------------------------------|--------|
| 41 | Iwoy boŋ - - - nda affowey - - - | - - - |
| - - - | Iwoy boŋ - - - nda affowey - - - | 40 + 5 |
| - - - | Iwoy boŋ 4 nda affowey 8 | - - - |
| 49 | Iwoy boŋ 4 nda affowey 9 | - - - |

2. Hinnawey wey hantum ma < wala > wala = dam gamey

ra.

28 ... 22 ; 42 ... 49 ; 34 ... 44

29 ... 20 + 9 ; 27 ... 33 ; 20 + 10 ... 31

30 ... 30 + 4.

3. Daaroo tee, ma hinnaa hantum kaŋ ga kaa jine nda woo
kaŋ ga kaa banda.

| | | |
|----|----|----|
| 43 | 44 | 45 |
| | 47 | |
| | 15 | |
| | 21 | |

4. Daaroo tee m'a timmandi nda harfu.

| | |
|----|-------------------|
| | Waranza cindi foo |
| 31 | |
| 44 | |
| 46 | |
| 28 | |
| 42 | |
| 49 | |
| 25 | |

5. Biyoo woo tee m'a timmandi nda fonda.

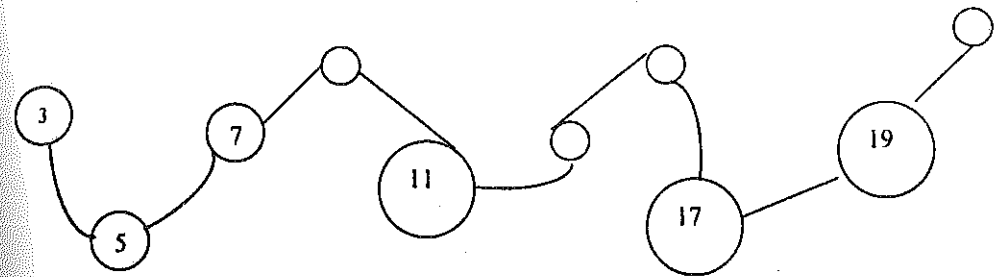

6. Hinnawey wey fesu-fesu hinna hinka.

32, 35, 30, 38, 37.

7. Hinnawey wey hangandi cere bande ka hun i kul ibeeroo
ga ka koy i kul ikaccaa ga.

36, 8, 17, 13, 29, 25, 31, 14, 22, 35.

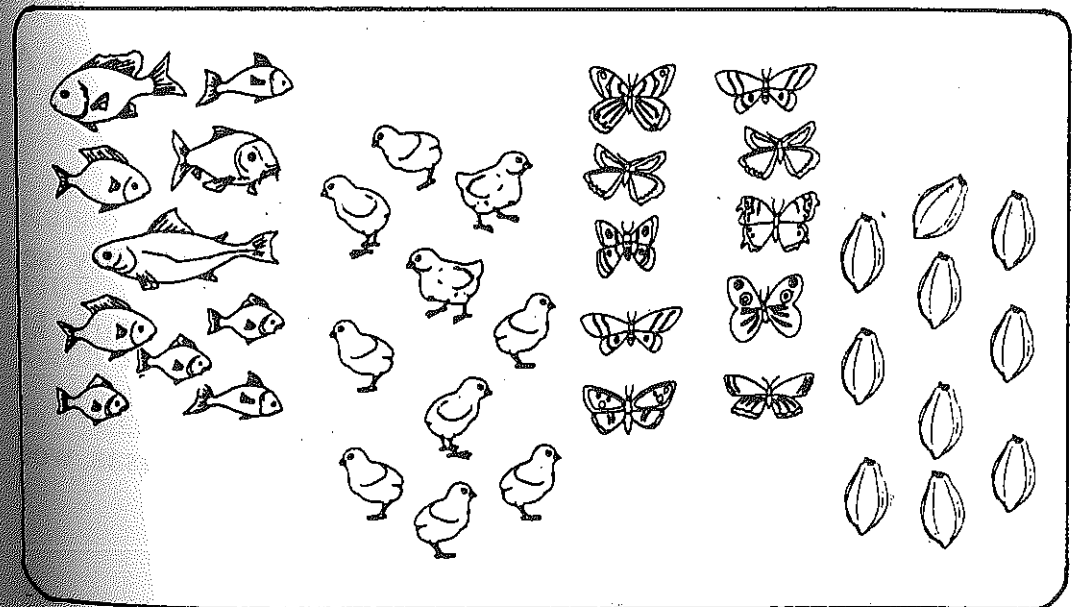

Caw : Mise kaŋ ra kaayan ga tee 40 ka koy 49

Taasiha : Taaliboo ma hin :

- ka miseyaŋ bay kaŋ ra kaayan goo, a m'i tee nda biiyaŋ ;
- ka kabu suka a m'a tee nda kabu-izeyaŋ ;
- ka boŋhaw tee kaŋ ra kaayan goo.

Kabu cahante :

- kabu nda iwoy-woy hala 60
- kabu nda waranka-waranka hala 60.

Goyjinawey : tondi-ize, bundu-ize, garbay, kangaw, dika, gorgo guuri, bonbon hkh.

Goyey

Goy jinaa : Alfagaa ma boŋhawoo woo har taalibey se :

Kangaw 30 goo Naana dikaa ra. A na kangaw 20 neere. Marje ka cindi a se ?

Taalibey ma neereyanoo misaa tee.

Alfagaa ma zaaboo hantum nda harfu walhabeeroo ga : « A cindi kangaw 10 ».

Taalibey ma woo hantum.

Goy hinkantoo : Alfagaa ma misaa woo noo taalibey se. « Muusa goo nda gorgo guuri 9. Ihinza kayri i ra. Marje ka cindi i ra ? ».

Taalibey ma misaa caw, i ma zaaboo ceeci. I ma misaa woo tee nda bii. Taalibey ma misaa hantum nda kabu-ize.

$$9 - 3 = \dots$$

I ma zaaboo hantum nda narfu.

« Muusa goo nda gorgo guuri 6 ».

Goy hinzantoo : Taalibey ma misey wey tee nda ijinawey takaa.

- Aliyyu goo nda bonbon-ize 8. A na ize guu neere. Bonbon-ize marje ka cindi.
- Mamma na tamaati-ize iyye kaa kaloo ra. Tamaati-ize marje no a hima ka kaa koyne ka duu tamaati-ize 12 ?
- Taalibi-ize 26 bara cawhugoo ra. Alfagaa na taalibi 5 kaataray. Marje ka cindi cawhugoo ra ?

Goy taacantoo : Alfagaa ma nee taalibey se i ma mise har kaŋ ra kaayan goo. I ma hāayanoo har, i ma misaa hantum nda kabu-ize. $7 - 3 = \dots$ $18 - 5 = \dots$

Goy guwantoo : Kaboo woo har ma a timmandi :

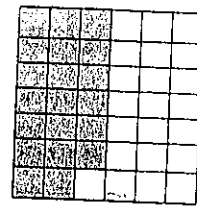

$$20 + \dots = 42$$

wala

$$\dots - \dots = \dots$$

Kala boro ma hugu too zeeri.

Goy idduwantoo : Isa na hamiisa 17 delbu. A na 4 noo nga ceroo se. Marje ka cindi a se ? Kaboo hantum nda kabu-ize m'i suka, ma zaaboo dam ganda.

$$17$$

$$- 4$$

$$=$$

Denden : kaayaney wey suka m'i zaabi.

9 - 4 = - - - ; 14 - 2 = - - - ; 19 - 6 = - - - ; 16 - 5 = - - -

Denden

1. Kaayaney wey kayandi m'i tee.

26 - 4 = . . . , 18 - 4 = . . . , 25 - 2 = . . . , 17 - 3 = . . .

2. Kaayaney wey tee m'i timmandi.

| | | | | | | | | | |
|-----|------|------|-----|-----|-----|------|------|---|----|
| 35 | 27 | 18 | 9 | . | . | . | . | . | 26 |
| - 4 | - 16 | - . | - . | - 6 | - 4 | - 22 | - . | - | . |
| = | = | = 12 | = 2 | = 3 | = | = 14 | = 16 | = | = |

3. Ciraw 17 goo tuuroo boŋ, itaaci deesi, marje ka cindi tuuroo ga.

4. Taalibi 28 no ma hima ka kaa cawdogoo ra, 8 mana kaa jina. Marje ka kaa cawdogoo ra ?

5. Saada almaaney ti boŋ 16. 13 kaa ka hun kurdogoo ra. Marje ka mana kaa ?

6. Fatto na k.29 ka koy yooboo ra, kaŋ a hun yooboo ra k.20 ka cindi a kone. Kaatibi marje no, a na dam nga muraadey ra ?

7. Ciraw 39 goo cere bande. Hookaw foo na ciraw 8 wii i ra. Ciraw marje ka bisa ?

8. Kaatibi marje no ma hun 36 ra 31 ma cindi ?

Caw : 50 hinnaa

Taasiha : Taaliboo ma hin :

- ka margari-izey hinnaa bay ;
- ka margari cin kaŋ izey ga sawa nda 50 ;
- ka 50 caw k'a hantum nda kabu-ize nda harfu ;
- ka 50 cin wala k'a fesu-fesu ;
- ka hangandi cere 0 ka koy 50 hinnawey.

Goyjinawey : bundu-ize, tondi, hkh.

Boŋkabu : Alfagaa ga hinnawey har nda affoo-foo, taalibey g'i hantum : 6 ; 15 ; 25 ; 40 ; 45.

Goyey

Goy jinaa : Alfagaa ma nee taalibey ma bundu 49 zaa. I m'i kanandi nda iwoy-woy. A m'i hãa wala iwoy boŋ marje no i duu. (iwoy boŋ taaci). Bundu-ize marje ka cindi ? (yagga). I kul ti cere ra marje ? (49). I ma bundu-ize foo tonton i ga. Taaliboo m'i kabu : i ti iwoy boŋ foo. Iwoy boŋ foo kaŋ tonton iwoy boŋ taaci ga : iwoy boŋ guu.

Goy hinkantoo : Alfagaa ma nee taalibey ma ngi walhawey zaa. I ma iwoy boŋ taacaa tee, i ma bundu-ize yagga tee jerey ga.

I ma affoo tonton i ga. I ma hinnaa kaŋ nda i ga sawa tee iwoy boŋ guu.

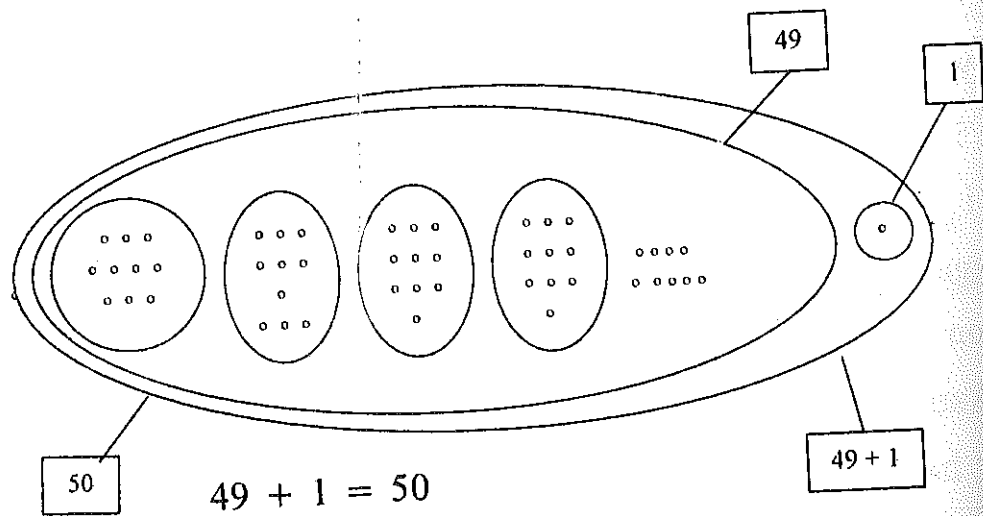
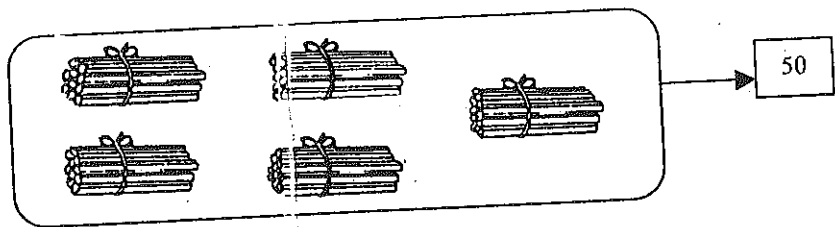
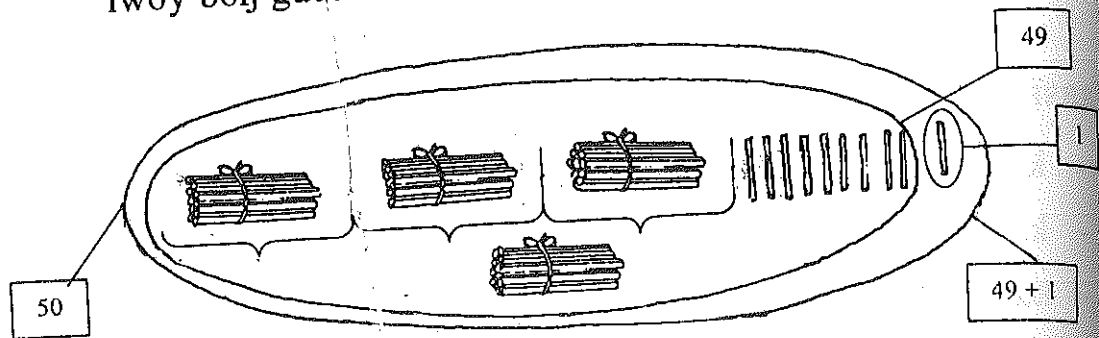

N.B. : Alfagaa ga goy follokaa tee walhabeeroo ga.

Goy hinzantoo : Alfagaa ma nee taalibey se i ma iwoy boŋ taaci nda bundu-ize yagga hinnaa hantum i cire. I ma affaa hinnaa hantum a cire. Alfagaa ma woyguu (50) hantum iwoy boŋ guwaa cire.

Goy taacantoo : Taalibey ma goyoo filla nda tondi-izey biyey.

Goy guwantoo : Alfagaa ma nee iwoy boŋ guu ti : « woyguu » (50). Taalibey m'a har a bande. Alfagaa ma woyguu hantum nda kabu-ize ; taalibey mo m'a hantum nda kabu-ize.

Goy idduwantoo : Alfagaa ma woyguu hantum nda harfu ; taalibey mo m'a hantum nda harfu.

Goy iyyantoo : Taalibey ma daaroo tee. Alfagaa m'i hãa wala marje ma huru iwoyey sorraa ra (5), I ma yaada (0) hantum nda kabu-ize affowey sorraa ra. A ma yee k'i hãa wala marje ma huru iwoyey sorraa ra (5). I ma igguu (5) hantum nda kabu-ize iwoyey sorraa ra.

Taalibey ma daaroo tee.

| Iwoyboŋey | Affowey |
|-----------|---------|
| 5 | 0 |
| | |

Goy yaahantoo : Alfagaa ma nee taalibey ma woyguu fesu-fesu : (hinna 2, wala 3, wala 4, wala 5).

$$50 = 25 + 25$$

$$50 = 20 + 20 + 10$$

$$50 = 10 + 10 + 10 + 20$$

$$50 = 25 + 15 + 5 + 5.$$

Goy yaggantoo : Margari fooyaŋ no ma tonton cere ga ka tee woyguu ?

$$10 + 15 + 8 + 7 + 5 + 5 = 50$$

$$25 + 25 = 50$$

$$18 + 9 + 13 + 10 = 50$$

$$30 + 5 + 5 + 10 = 50$$

Goy woyantoo : Alfagaa ma nee taalibey ma denden iyyantoo filla.

Denden : Woo berandi, m'a timmandi.

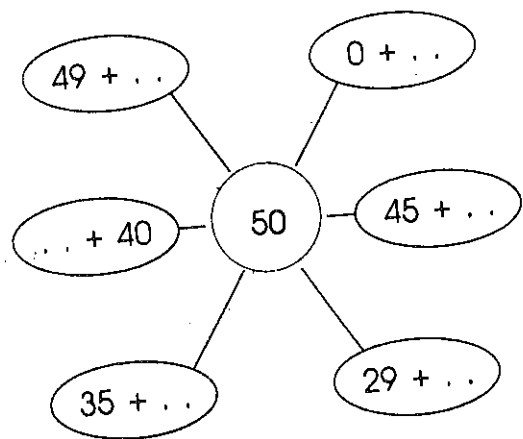

Denden

1. 50 (woyguu) hantum daaroo ra.

| Iwoyey | Affowey |
|--------|---------|
| | |

2. Margarey wey timmandi woyguu :

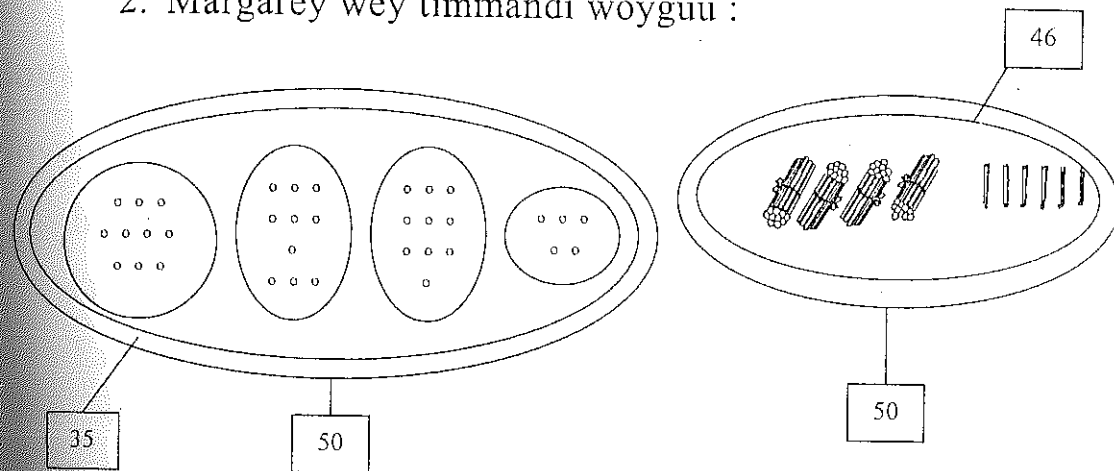

- 50 hantum harfu ra.
- 50 fesu-fesu margari 5.
- Margari 6 tee kaŋ ga tonton cere ga ka sawa nda 50
- Fesu-fesey wey tee m'i timmandi.

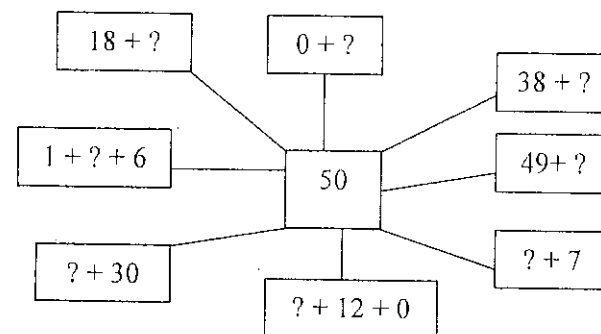

7. Hinna wey hanga-hangandi cere 0 ka koy 50.

Filla : 50 hinnaa

Alfagaa ma nee taalibey ma dendeney wey tee.

Denden

- Hinnawey hanga-hangandi 0 ka koy 50.
- Hinnawey wey hantum ma $< wala > wala =$ dam gamey ra.
 $20 --- 41 ; \quad 15 --- 7+6 ; \quad 39 --- 21 ; \quad 49 --- 23+26 ;$
 $36+13 --- 50.$
- Hinnawey hanga-hangandi ka hun 40 ka kaa 0 ga.
- Hinnawey wey fesu-fesu, i ma ti hinna hinka.
 $50 ; 47 ; 36 ; 25 ; 14 ; 3.$
- Hinnawey hantum nda harfu.
 $48, 36, 25, 43, 17$
- Hinnawey hantum nda kabu-ize.
 Waranza, iwoy cindi yagga, woytaaci, woyguu.
- Kabey wey tee.

$$\begin{array}{r} 50 \\ - 30 \\ \hline = \end{array} \quad \begin{array}{r} 47 \\ - 25 \\ \hline = \end{array} \quad \begin{array}{r} 48 \\ - 36 \\ \hline = \end{array} \quad \begin{array}{r} 31 \\ - 20 \\ \hline = \end{array} \quad \begin{array}{r} 28 \\ - 7 \\ \hline = \end{array}$$

- Kaayaney wey suka, m'i tee
 $47 - 35 ; \quad 46 - 24 ; \quad 34 - 13 ; \quad 28 - 6 ; \quad 50 - 20.$
- Boghaw
 Naana na bundiya 36 ton. Mohammadu na ize 25 gaa a ra.
 Bundiya marje ka cindi dogey ra ?
- Muusa goo nda gorgo-ize 50, gaboo na ize 10 zaa i ra.
 Gorgo-ize marje ka cindi Muusa se ?

Caw : Tontonyan kaŋ goo nda lanbari 0 ka koy 50

Taasiha : Taaliboo ma hin :

- ka tontonyan tee ka nga zaari kul almusakkawey hanse ;
- ka tontonyan tee kaŋ goo nda lanbari.

Kabu cahante

- Kabu nda igguu-guu = 0 ka koy 50.
- Kabu nda igguu-guu = 50 ka yee 0.

Goyjinawey : Goyjinawey kaŋ ga duwandi.

Goyey

Boghaw 1 : Muusa nda Ali ga feraw kar. Muusa na feraw 26 kar. Ali na feraw 9 kar. Feraw marje no Muusa nda Ali kara ?

Laasaabu :

- Feraw marje no Muusa n'i kar ?
- Feraw marje no Ali n'i kar ?
- Marje ti ferawey cere ra ?
- Kabu dumi foo ma tee ?

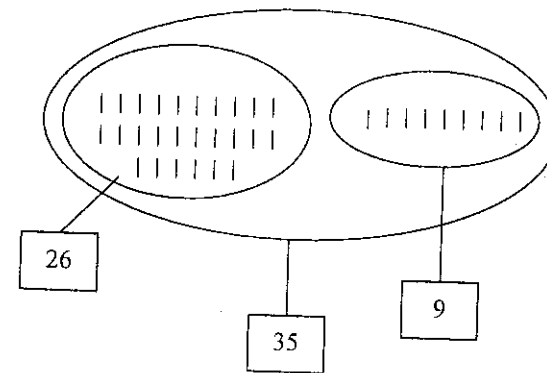

Caw : 50 ka koy 59 hinnawey

Taasiha : Taaliboo ma hin :

- ka margari-izey hinnaa kaŋ goo margari ra bay ;
- ka 50 ka koy 59 hinnawey caw, k'i hantum kabu-ize nda harfu ra ;
- ka jinayyaŋ kanandi nda iwoy-woy, a ma iwoy boŋey nda affowey fay, a m'i hantum ;
- ka hinnabayray goyjinawey ka hinna tana cebe ;
- ka kabu-ize foo alkadaroo bay hinna ra ;
- ka 50 ka koy 59 hinnawey fesu-fesu wala k'i cin, sanda ka iwoy boŋey nda affowey bayrandi ;
- ka jinay margari tee kaŋ margari-izey hinnaa bayrandi ;
- ka 0 ka koy 59 hinnawey hanga-hangandi cere bande, ka kabu 1 ka koy 59 ga.

Kabu cahante :

- kabu nda igguu-guu hala 50.
- kabu nda iwoy-woy hala 50.

Goy jinawey : bundu-ize, tondi, hinnabayray goyjinawey nda goyjinawey kaŋ ga duwandi.

Goyey

Goy jinaa : Alfagaa ma nee taalibi foo kul ma :

- bundu-ize 10 hawari 4 nda bundu-ize 9 jisi nga jine taabaloo boŋ ;
- bundu-ize 1 tonton bundu-ize 9 ga, a ma bundu-ize woyaa (10) barmay nda iwoy hawari 1 ;

- alfagaa ma hantum walhabeeroo ga : 50, a m'a har, a m'a hantum nda harfu : woyguu ;

Goy hinkantoo : Alfagaa ma 51 hantum, a m'a har, taalibey m'a har a bande.

- Alfagaa ma nee taalibey ma bundu-ize 10 hawari nda bundu-ize hinnaa alkadaroo cebe kaŋ ga sawa nda 51. Maanaa : bundu-ize 10 hawari 5 nda bundu-ize 1.

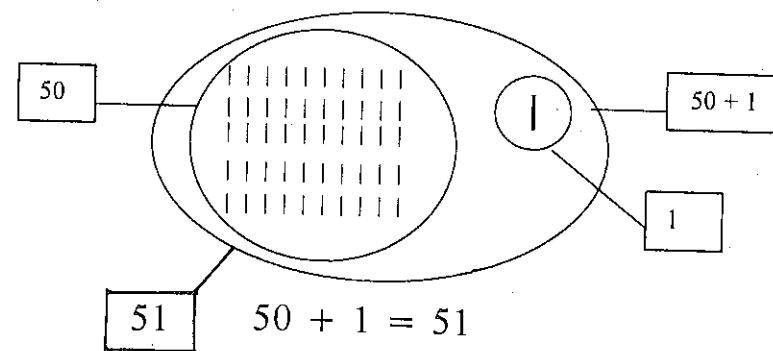

- Alfagaa nda taalibey ma yee goy follokaa ga nda hinnawey wey : 52, 53, 54, 55, 56, 57, 58, 59.

Goy hinzantoo : Alfagaa ma nee taalibey ma 51 hantum kabu-ize nda harfu ra, i m'a cebe.

- Alfagaa ma taalibey fahamandi kaŋ :
51 ra, 5 mana ti kala iwoyey kabu-izoo ; 1 mana ti kala affowey kabu-izoo.
53 ra, 3 mana ti kala affowey kabu-izoo ; 5 mana ti kala iwoyey kabu-izoo.
- Alfagaa ma kabu-ize foo kul alkadaroo fahamandi hinnawey wey ra : 0 ka koy 59 hinnawey.

3. Hinnawey wey deedandi nda tammaasawey affoo :

>, <wala =

$$30 + 5 + 20 \dots\dots 30 + 20$$

$$25 + 22 + 12 \dots\dots 2 + 20 + 50$$

$$12 + 28 + 25 \dots\dots 25 + 12 + 28$$

4. Sorko wey foo na hamiisa 46 neere subbaahoo ra. A na hamiisa 35 neere alaasaroo ra. Hamiisa marje no a n'a neere zaaroo ra ?

5. Sahalu na sun 17 fanji Adama pinaasoo ra. Dunday na sun 25 tonton i ga. Nd'a gar pinaasoo ga hin ka sun 61 zaa sun marje no Buuba ga hin k'i fanji pinaasoo ra ?

6. Kaatibi 70 goo Adiiza kone. A na kayye foo day kaatibi 45 nda kalam foo k.15. Kaatibi marje ka cindi Adiiza se ?

7. Sorko foo na barra 75 dii nga sankawey ra. Izewoy beeroo na barra 38 neere, ikaccaa na 27 neere. Barra marje ka cindi ?

8. Kaaji taalibey na guusu 73 fansi tuuri dumayan se. I na miliya 25 nda makkabaani 39 дума. Guusu marje ka cindi kaŋ ra tuuri mana дума ?

9. Mamadu na leemur 52 kosu. Siidi na leemur 25 kosu. Leemur marje no ngi boro hinkaa n'i kosu ?

Caw : 80 hinnaa

Taasiha : Taaliboo ma hin :

- ka margari cin kaŋ ga sawa nda 80 ;
- ka 80 caw, k'a hantum nda kabu-ize nda harfu ;
- ka 80 cin wala k'a fesu-fesu ;
- ka 0 ka koy 80 hinnawey hanga-hangandi cere ;
- ka kabu affoo ka koy 80.

Kabu cahante :

- Kabu nda iwoy-woy ka hun 0 ka koy 70 ;
- kabu nda igguu-guu ka hun 0 ka koy 75.

Goyjinawey : bundu-ize, tondi.

Goyey

Goy jinaa : Taalibi foo kul ma bundu-ize iwoy boŋ 7 nda bundu-ize 9 kabu.

- A ma bundu-ize foo tonton 9 ga.



$$9 + 1 = 10 = \text{iwoy boŋ foo.}$$

Nda iwoy boŋ foo tonton iwoy boŋ iyye ga, ga sawa nda.

$$70 + 10 = 80$$

- Iwoy boŋ marje no ni ga duu, m'a hantum daaroo ra.

| Iwoyey | Affowey |
|--------|---------|
| | |

Bundu-ize 80 = iwoy boŋ 8 nda affowey 0.
 Tiira 80 = iwoy boŋ 8 nda affowey 0.
 Haw 80 = iwoy boŋ marje no ?

Goy hinkantoo : Hanga-hangandi cere : 0 ka koy 80
 hinnawey sanda 0-10-20-30-40-50-60-70-80
 - Kabu 0 ka koy 80 hinnawey nda 80 ka yee 0

Denden

- Kabu nda 10-10 : 0 ka koy 80 hinnawey
 Kabu nda 5-5 : 0 ka koy 80 hinnawey
 Kabu nda 20-20 ka koy 80 hinnaa
- Kabu nda 10 : 80 ka yee 0
 40 : 80 ka yee 0

Denden

$$\begin{array}{r}
 37 \\
 +42 \\
 \hline
 =
 \end{array}
 \quad
 \begin{array}{r}
 35 \\
 +13 \\
 \hline
 =
 \end{array}
 \quad
 \begin{array}{r}
 26 \\
 +18 \\
 \hline
 =
 \end{array}
 \quad
 \begin{array}{r}
 56 \\
 +24 \\
 \hline
 =
 \end{array}
 \quad
 \begin{array}{r}
 47 \\
 +29 \\
 \hline
 =
 \end{array}
 \quad
 \begin{array}{r}
 38 \\
 +42 \\
 \hline
 =
 \end{array}$$

3. Daaroo woo tee m'a timmandi.

| | | | |
|----|----------------------------|------|-------------------|
| 55 | Iwoy boŋ .. nda affowey .. | 50+5 | ----- |
| .. | Iwoy boŋ .. nda affowey .. | | Woydu cindi hinza |
| .. | Iwoy boŋ 7 nda affowey 9 | | ----- |
| 73 | Iwoy boŋ .. nda affowey .. | | ----- |
| .. | Iwoy boŋ nda affowey | 70+0 | ----- |
| 77 | Iwoy boŋ .. nda affowey .. | | ----- |

4. Tammaasawey wey <, > wala = dam.

- 35 ----- 45
 59 ----- 69
 57 ----- 50 + 7
 50 ----- 49 + 1
 47 ----- 74
 70 ----- 80
 65 ----- 80

5. Aminta duu mangoro 54, naŋoo n'a noo mangoro 24. Mangoro marje no Aminta duu ?

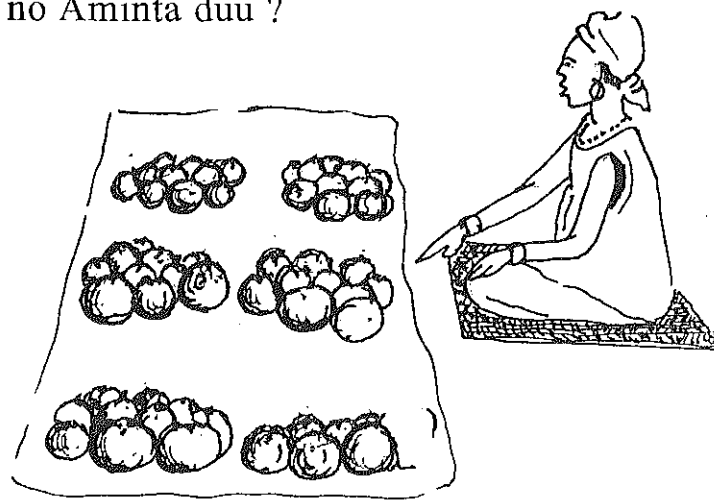

Caw : Tontonyan nda kaayan:80 hinnaa

aaasiha : Taaliboo ma hin :

- ka kaayan wala tontonyan mise bay ;
- ka kaayan wala tontonyan tee ;
- ka mise kaɗ ra tontonyan wala kaayan goo boɗfeeraa tee.

Goyjinawey : Goyjinawey kaɗ ga duwandi..

Goyey

Boɗhaw : Benke kaaroo tun Gaawoo nda boro 80. Boro 22 zunbu Mowti, 35 zunbu Segu. Boro marje ka cindi kaaroo ra kaɗ a ga too Bamako ?

Laasaabu : Boro marje nda kaaroo tun Gaawoo ?

Boro marje ka zunbu fondaara ?

Marje ti naarukey hinnaa kaɗ zunbu teesa* kokorantaa ra ?

Kabu dumi foo no boro g'a tee ka duu borey hinnaa kaɗ zunbu fondaara ?

Kabu dumi foo no boro g'a tee ka duu naarukey hinnaa kaɗ too Bamako ?

Kabu dumey daaru, m'i tee.

Borey kaɗ zunbu fondaara ra hinnaa ti :

$$22 + 35 = 57$$

* teesa : moototeesa = gaar = fandidoo

Naarukey kaɗ too Bamako hinnaa ti :

$$80 - 57 = ?$$

Denden

1. Tontoney tee.

| | | | | | |
|-----|-----|-----|-----|-----|-----|
| 36 | 44 | 65 | 53 | 32 | 38 |
| +27 | +36 | +14 | +27 | +47 | +42 |
| = | = | = | = | = | = |

2. Kaayaney tee.

| | | | | | |
|-----|-----|-----|-----|----|-----|
| 75 | 80 | 69 | 80 | 80 | 68 |
| -38 | -49 | -15 | -20 | -8 | -42 |
| = | = | = | = | = | = |

3. Timmandi.

| | | | |
|------|------|------|------|
| 43 | 16 | 77 | .. |
| + .. | + 6. | - .. | - 49 |
| = 79 | = 80 | = 58 | = 31 |

4. Hinnawey wey deedandi nda tammaasawey wey affoo :

>, < wala =

$$40 + 6 + 10 - - - - 30 + 25$$

$$23 + 19 + 13 - - - 3 + 17 + 40$$

$$24 + 10 + 15 - - - 10 + 24 + 15$$

5. Hamma na kaatibi 20 fita nda kaatibi 45 sukar zaa. A na neerekaa noo kaatibi 80. Marje no neerekaa g'a yeeti a se ?

foo ga tee jirbi hinza ra. Zurandikaw 79
 jinaa boro 24 fura, zaari hinkantoo, boro
 o ka zuraa benandi ?
 a, gorodoo 30 bara beene, 45 goo ganda,
 goro. Gorodoo marje ka cindi ?
 i 35 kaa sardiŋaa ra. Woyme beeroo n'a
 Tamaati marje bara Fattu kokondaa ra ?
 73 tee. A na 65 neere. Furme marje ka

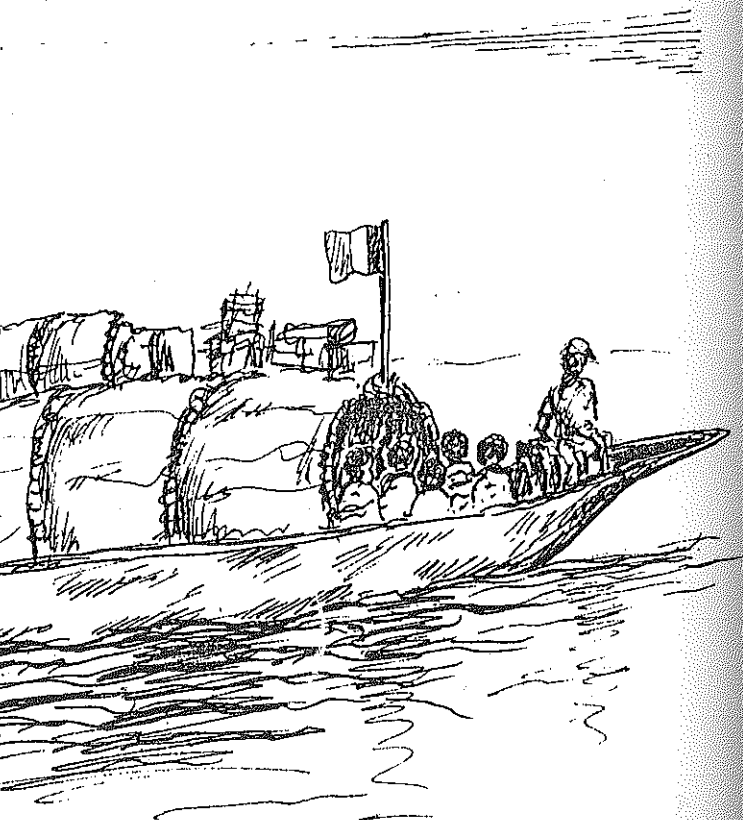

Caw : 80 ka koy 89 hinnawey

Taasiha : Taaliboo ma hin:

- ka margari-izey hinnaa kaŋ goo margari ra bay ;
- ka hun 80 ka koy 89 hinnawey caw, k'i hantum kabu-ize nda harfu ra ;
- ka jinayyaŋ kanandi nda iwoy-woy, a ma iwoyboŋey nda affowey fay, a m'i hantum ;
- ka hinnabayray goyjinawey ka hinna tana cebe ;
- ka kabu-ize foo alkadaroo bay hinna ra ;
- ka hun 80 ka koy 89 hinnawey fesu-fesu wala k'i cin sanda ka iwoy boŋey nda affowey bayrandi ;
- ka jinay margari tee kaŋ margari-izey hinnaa ga bayrandi ;
- ka 0 ka koy 89 hinnawey hanga-hangandi cere bande.

Kabu cahante

- Kabu nda itaaci-taaci hala 80 ;
- kabu nda yaaha-yaaha hala 80 ;
- kabu nda waranka-waranka hala 80.

Goyjinawey : bundu-ize, tondi, hinna bayray goyjinawey nda goyjinawey kaŋ ga duwandi.

Goyey

Goy jinaa : Alfagaa ma nee taalibi foo kul ma :

- bundu-ize 10 hawari 7 nda bundu-ize 9 jisi nga jine taabaloo bon :

- bundu-ize 10 hawari hinnaa kaɗ a duu a hantum : 8.

Goy hinkantoo : Alfagaa ma 81 hantum, a m'a har, taalibey m'a har a bande.

- Alfagaa ma nee taalibey ma bundu-ize 10 hawari nda bundu-ize hinnaa cebe kaɗ ga sawa nda 81. Maanaa bundu-ize hawari 8 nda bundu-ize 1.

- Alfagaa nda taalibey ma yee goy follokaa ga nda hinnawey wey : 82 ka koy 89 hinnawey. $80 + 1 = 81$

Goy hinzantoo :

a. Daaroo tee m'a timmandi.

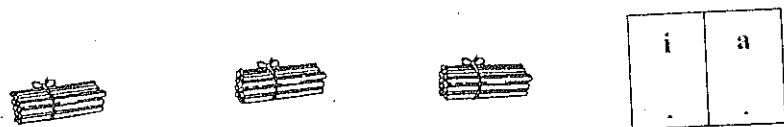

b. Biyoo tee ma hinnaa hantum daaroo ra



c. Bundu-ize 10 hawari nda bundu-ize hinnaa biyey tee ka duu hinnaa kaɗ goo hugu-izoo ra : 85 ; 78 ; 82.

d. Daaroo tee m'a timmandi :

| | | | |
|----|----------------------------|--------|----------------------|
| .. | Iwoy boɗ .. nda affowey .. | 80 + 6 | .. |
| .. | Iwoy boɗ .. nda affowey .. | .. | Woyyaaha cindi taaci |
| 80 | Iwoy boɗ .. nda affowey .. | .. | .. |
| .. | Iwoy boɗ 6 nda affowey 7 | .. | .. |
| .. | Iwoy boɗ .. nda affowey .. | 70 + 8 | .. |

Goy taacantoo : hinnawey 0 ka koy 89 deedandi. Deedandoo ga hin ka tee nda taka hinka.

Ijinaa : 70 ga jin 83 se, saa din 70 kacca nda 83, boro ga hantum $70 < 83$ wala $83 > 70$.

Ihinkantoo : kabu-ize foo alkadaroo hinnaa ra : hinnawey kaɗ iwoy boɗey ga fay, sanda ka 84 nda 87 deedandi.

Hinna beeroo ti woo kaɗ goo nda iwoy boɗ beeroo, maanaa $87 > 84$ wala $84 < 87$.

Denden

1. Daroo tee, m'a timmandi

| | |
|----|------------------|
| 76 | |
| 67 | Woydu cindi iyye |
| 80 | |
| 89 | |

2. Tammaasawey wey dam dogey ra : $>$, $<$ wala =

- | | | |
|----------|-----------------|-----------------|
| 79 .. 81 | 39 .. 50 | 84 .. 78 |
| 61 .. 58 | 75 .. $50 + 7$ | $54 + 10$.. 66 |
| 18 .. 81 | $40 + 40$.. 70 | 71 .. 81 |
| 77 .. 11 | 63 .. $50 + 13$ | 71 .. $60 + 11$ |

3. Hinnawey kaŋ kacca nda 75 berandi m'i koli

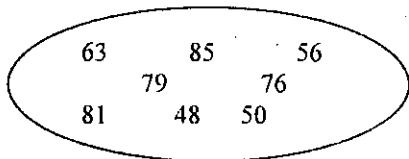

4. Hinnawey kaŋ beeri nda 80 berandi m'i koli

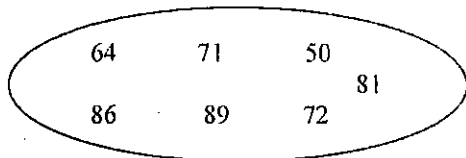

5. Daaroo tee m'a timmandi :

| | | | |
|----|----------------------|----------------------------|----------|
| 76 | .. | Iwoy boŋ .. nda affowey .. | $70 + 6$ |
| .. | Woyyaaha cindi hinka | Iwoy boŋ .. nda affowey .. | $80 + 2$ |
| 57 | .. | Iwoy boŋ .. nda affowey .. | .. |
| .. | .. | Iwoy boŋ 3 nda affowey 5 | .. |
| 86 | .. | Iwoy boŋ .. nda affowey .. | .. |

6. Woo tee ma hinna foo kul dobu nga fesu-fesuyaney ga nda zeeri.

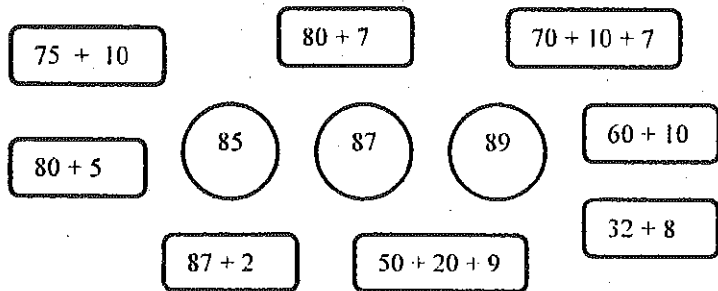

Caw : Tontonyan nda kaayan:80 ka koy 89-hinnawey

Taasiha : Taaliboo ma hin :

- ka kaayan wala tontonyan mise bay ;
- ka kaayan wala tontonyan tee ;
- ka mise kaŋ ra tontonyan wala kaayan goo boŋfeeraa tee.

Goyjinawey : Goyjinawey kaŋ ga duwandi.

Goyey

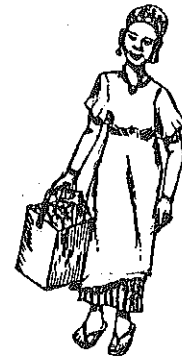

Bonhaw : Salma doo yooboo ra nda galaasi 62. Galaasi 43 day, 17 menne. Galaasi marje ka cindi kaŋ ga hin ka neerandi ?

Laasaabu : Galaasi marje nda Salma tun hugey ?

Galaasi marje ka dayandi ?

Galaasi marje ka hasara Salma se ?

Marje no ma hun galaasey ra ?

Galaasi marje ka cindi kaŋ ga hin ka neerandi ?

- Kabu dumi foo no ma tee ka duu galaasey hinnaa kaŋ hun ?

- Kabu dumi foo no boro g'a tee ka duu galaasi hinnaa kaŋ ga hin ka neerandi ?

- Kabu dumey daaru m'i tee.

Galaasi hinnaa kaḅ hun ti :

$$43 + 17 = 60$$

Galaasi hinnaa kaḅ ga hin ka neerandi ti :

$$62 - 60 = ?$$

Denden

1. Tontonyaney tee.

| | | | | |
|-------|-------|-------|-------|-------|
| 44 | 55 | 56 | 63 | 43 |
| +37 | +28 | +28 | +21 | +37 |
| <hr/> | <hr/> | <hr/> | <hr/> | <hr/> |
| = | = | = | = | = |

2. Kaayaney tee.

| | | | | |
|-------|-------|-------|-------|-------|
| 85 | 82 | 89 | 81 | 86 |
| -36 | -43 | -40 | -9 | -76 |
| <hr/> | <hr/> | <hr/> | <hr/> | <hr/> |
| = | = | = | = | = |

3. Timmandi.

| | | | |
|-------|-------|-------|-------|
| 53 | 47 | 86 | .. |
| + .. | + .. | - .. | -56 |
| <hr/> | <hr/> | <hr/> | <hr/> |
| = 85 | = 89 | = 42 | = 24 |

4. Hinnawey wey deedandi nda tammaasawey wey affoo :

>, < wala =

$$50 + 7 + 20 \text{ --- } 60 + 27$$

$$4 + 18 + 23 \text{ --- } 4 + 18 + 50$$

$$43 + 21 + 7 \text{ --- } 7 + 21 + 43$$

5. Miniti 60 bara guuru foo ra. Sumaana na miniti 23 tee koyraa nda galloo game. Kaḅ a ga yee, a na miniti 25 tee.

Miniti marje k'a kuma a ma guuru foo tee ?

6. Baggoo si hin haya kaḅ bisa ton 70. Loore hinza ma hima ka deḅ. Ijinaa tiḅaa ti ton 30, ihinkantoo tiḅaa ti 27, ihinzantoo, ton 15. Baggoo ga hin ka loorawey kul zaa wala ?
7. Boro 65 no ma hin ka Mohomodu faaroo beeri. Atinnoo hane boro 25 koy goy. Alhamiisa hane goykaw 27 no a duu. Boro marje no a ga hima ka zaa goyoo ma ben alhadoo hane ?
8. Agiisa goo nda alman boḅ 83 kaḅ gaaru 17 nda feeji-ize 45 bara i ra. Marje ti feeji woyey hinnaa ?
9. Kaydiyaa ra milimeetar 82 ncirpi ka kaḅ Jenne. Tunbutu duu ncirpi hinza jiiroo ra : milimeetar 23 nda milimeetar 42 nda milimeetar 5. Milimeetar marje nda Jenne bisa Tunbutu ?
10. Hamiisa hinka tiḅaa cere ra ti kilo 60. Ham-izoo tiḅaa ti kilo 45. Marje ti deesoo tiḅaa ?
11. Meetar 70 guusuyan no Jebok day taagaa ga hima ka duu a. Meetar 35 no fansakaa duu kaḅ a wirci. Meetar marje ka cindi a se ?
12. Manna milimeetar 85 ncirpi n'ir duu. Haray jiiroo ir mana duu kala milimeetar 77. Milimeetar marje nda manna bisa jiiroo ?
13. Feraw 64 ma hima ka karandi. Kuray jinaa ga feraw 23 kar, ihinkantoo 22. Feraw marje no kuray koraa ga kara ?

Caw : 90 hinnaa

Taasiha : Taaliboo ma hin :

- ka margari-izey hinnaa bay ;
- ka margari cin kañ izey ga sawa nda 90 ;
- ka 90 caw k'a hantum nda kabu-ize nda harfu ;
- ka 90 cin wala k'a fesu-fesu.

Goyjinawey : bundu-ize, tondi-ize, garbay guli.

Kabu cahante :

- Kabu nda 10-10 ka hun 0 ka koy 80 ;
- Kabu nda 1-1 ka hun 80 ka koy 89 ;
- Muusa goo nda teenay 83, Isaa n'a noo teenay 5. Marje ti Muusa teenawey hinnaa sohō ?

Goyey

Goy jinaa : Alfagaa ma nee taalibey ma bundu-ize 89 zaa iwoy-woy boñ nda affo-foo. A m'i hāa : iwoy boñ marje nda bundu-ize marje no ? (iwoy boñ 8 nda bundu-ize 9). A ma nee taalibey ma 89 hantum.

Alfagaa ma nee taalibey ma yee ka bundu-ize foo zaa, i m'a tonton 89 margaroo ga. Alfagaa m'i hāa : iwoy boñ marje no war duu sohō ? (iwoy boñ 9 kañ banda ga haya kul mana cindi). Alfagaa ma nee : « Woo ti bundu-ize woy yagga ». Taalibey m'a har-har.

Goy hinkantoo : Alfagaa ma nee taalibey ma ngi walhawey zaa. Nga nd'ey ma goyoo biyoo tee walhawey ga.

Goy hinzantoo : Alfagaa nda taalibey ma margari foo hinnaa hantum a cire. A ma nee taalibey ma 90 hantumoo laasaabu, a m'i hāa : kabu-ize marje ma 90 hantum ? Marje ti iwoy boñey kabu-izoo, nda affowey kabu-izoo ?

Taalibey ma 90 hantum. Alfagaa ma 90 hantum nda harfu, taalibey mo m'a hantum.

Goy taacantoo : Alfagaa ma nee taalibey ma 90 cin cee boobo nda goyjinay tanayañ sanda tondi-izey nda garbay guley.

Denden : Kabey wey timmandi

$$\begin{array}{cccccccc}
 50 & 45 & 48 & 60 & 73 & & 39 & 66 & 75 \\
 + 40 & + \dots & + 42 & + 30 & + \dots & + & 51 & + 24 & + 15 \\
 \hline
 = & = 90 & = & = & = & = & = & = & =
 \end{array}$$

Goy guwantoo : Alfagaa ma willi 90 hantumoo ga nda kabu-izey. A ma nee taalibey ma iwoy boñey hinnaa har, i ma affowey sorraa wanoo har.

Goy idduwantoo : Alfagaa ma nee taalibey m'a fesu-fesu (hinna hinka, nda hinna hinza, nda hinna 9, nda hinna 5...) sanda :
 $90 = 45 + 45$; $90 = 40 + 40 + 10$; $90 = 20 + 20 + 20 + 20 + 10$;
 $90 = 10 + 10 + 10 + 10 + 10 + 10 + 10 + 10 + 10$.

Goy iyyantoo : Alfagaa ma taalibey hāa nda margarey kañ ga huru cere ga ka 90 cin sanda :

$$\begin{array}{l}
 45 + 45 = 90 ; \quad 40 + 50 = 90 ; \quad 30 + 30 + 30 = 90 ; \\
 40 + 30 + 20 = 90 ; \quad 30 + 20 + 10 + 25 + 5 = 90.
 \end{array}$$

Denden

- Hinnawey durse ka hun 80 ka koy 90 nda affoo-foo.
- Hinnawey durse ka hun 90 ka doo 80 nda affoo-foo.
- Hinnawey wey deedandi nda $<$, wala $>$.
86 nda 90 ; 79 nda 90 ; 90 nda 85 ; 90 nda 68.
- Hinnawey wey hanga-hangandi cere bande ka hun i kul ibeeroo ga ka koy i kul ikaccaa ga : 35, 28, 59, 60, 17, 89, 46, 90.
- Hinna follokey hanga-hangandi cere bande ka hun i kul ikaccaa ga ka koy i kul ibeeroo ga.
- 90 fesu-fesu margari 1 nda 5.
- Margari 4 tee kaŋ ga tonton cere ga ka ti 90.
- 90 fesu-fesey wey timmandi.

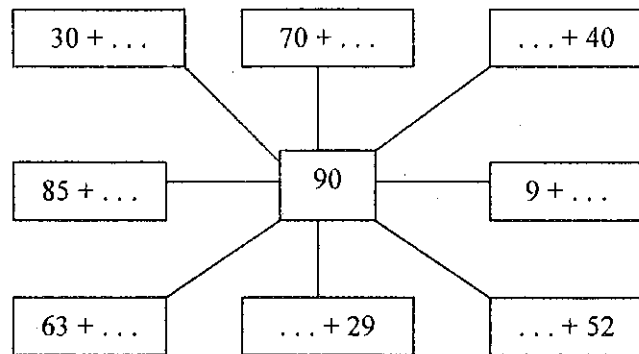

Caw : 90 ka koy 99 hinnawey

Taasiha : Taaliboo ma hin :

- ka margari-izey hinnaa bay margari ra ;
- ka hinnawey cin ka hun 90 ga ka koy 99 ;
- k'i caw, k'i hantum nda kabu-ize nda harfu ;
- ka margari tee kaŋ ra margari-ize 90 goo, ka iwoy boŋey nd'affowey kabu, ka zaaboo hantum ;
- ka kabu-izey dogoo bay hinna ra ;
- ka hinna cin, k'a fesu-fesu : 90 ka koy 99 (iwoy boŋey nda affowey) ;
- ka margari tee kaŋ margari-izey ga bayrandi ;
- ka hinnawey hanga-hangandi cere bande 90 ka koy 99 ;
- ka hinnawey durse 90 ka koy 99.

Goyjinawey : Tondi-ize, bundu-ize, garbay guli.

Kabu cahante :

- Kabu nd'iwoy-woy ka hun 0 ka koy 90 ;
- Kabu nd'affoo-foo ka hun 80 ka koy 90.

Goyey

Goy jinaa : Alfagaa ma nee taalibey ma bundu-ize 90 margari foo kabu nd'iwoy-woy, i ma 90 hantum nda kabu-ize nda harfu.

- Alfagaa ma yee ka nee taalibey ma bundu-ize foo sanbu, i m'a tonton woy yaggaa ga. Taalibey ma laasaabu kaŋ bundu-ize iwoy boŋ 9 nda bundu-ize foo no. Alfagaa ma

nee : « Woo ti bundu-ize woy yagga cindi foo.» Taalibey m'a har-har.

- Alfagaa nda taalibey ma goyoo biyoo tee, i ma margari foo kul hinnaa hantum a cire ?

Alfagaa nda taalibey ma 91 hantum walhawey ga nda kabu-ize nda harfu. Taalibey ma laasaabu kan kabu-ize hinka ma 91 hantum : iwoy boŋ 9 nda affowey 1.

Goy hinkantoo : Alfagaa ma nee taalibey ma bundu-ize 91 margaroo sanbu, i ma yee ka bundu-ize foo zaa, i m'a tonton a ga.

I ma laasaabu kan ngi duu iwoy boŋ 9 nda bundu-ize 2.

Alfagaa ma nee : woo ti bundu-ize 92. Taalibey m'a har-har.

Alfagaa nda taalibey ma goyoo biyoo tee walhawey ga, i ma margari foo kul hinnaa hantum a cire, i ma 92 hantum kabu-ize nda harfu ra.

Goy hinzantoo : Alfagaa nda taalibey ma hinnawey cindey cin hala 99 ga nda taka follokaa.

- I ma goyey filla nda goyjinay tana (tondi-ize, wala garbay guli).

- Taalibey ma hinnawey kabu ka hun 90 ka koy 99 nda ka hun 99 ka kaa 90.

Denden

1. Tondi-izey wey biyey tee, ma ngi hinnaa hantum dengaroo* ra kan goo margaroo jeroo ga.

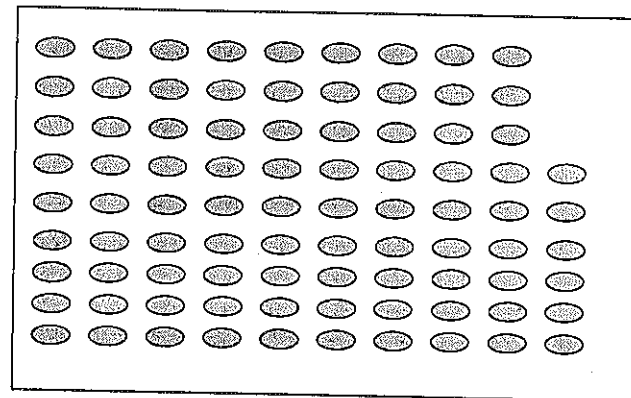

2. Biyey tee m'i timmandi ka duu 98.

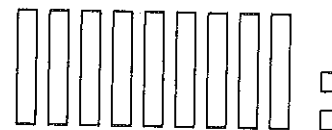

3. Daaroo tee, ma goyoo timmandi.

| | | |
|----|----------------------------------|-----------------|
| 91 | Iwoy boŋ - - - - nda affoo - - - | 90 nda 1 |
| .. | Iwoy boŋ - - - - nda affoo - - - | 90 nda 5 |
| 99 | Iwoy boŋ - - - - nda affoo - - - | - - - nda - - - |
| .. | Iwoy boŋ yagga nda affoo iyye | - - - nda - - - |
| .. | Iwoy boŋ yagga nda affoo yaada | - - - nda - - - |

4. Hinnawey wey deedandi nda <wala> wala = .
90 nda 98 ; 93 nda 95 ; 96 nda 90 ; 91 nda 97 ; 99 nda 98 ;
95 nda 95

* dengari : kaddasu-ize kan i g'a dam jinay ga ka duu k'a bay (étiquette).

Caw : Tontonyan nda kaayan hinnawey ga,
ka hun 90 ka koy 99.

Taasiha : Taaliboo ma hin :

- ka tontonyan tee hinnawey ga ka hun 90 ka koy 99 ;
- ka kaayan tee hinnawey ga ka hun 90 ka koy 99.

Goyjinawey : Wey kaŋ goo sunduku sukantaa ra.

Kabu cahante : 5 hinka tonton 10 ga, marje no ?

Muusa goo nda bonbon 15. A na Aysata noo bonbon 5. Marje ka cindi Muusa se ?

Goyey

Goy jinaa : Bonhaw : Isa na foolo-ize hinka teenay day. A na teenay 45 gar foolo-ize jinaa ra, a na teenay 52 gar ihinkantoo ra. Marje ti Isa teenawey hinnaa ?

Laasaabu : (cawyan banda ga). Alfagaa ma taalibey hãa.

- Teenay foolo marje no Isa day ?
- Teenay marje ma bara foolo-ize jinaa ra ?
- Teenay marje ma bara foolo-ize hinkantoo ra ?
- Macin no ir ga hima k'a ceeci ?
- Kabu cille foo m'ir noo Isa teenawey hinnaa ?
- Hinna foo nda hinna foo n'ir g'i tonton cere ga ?

Alfagaa ma nee i ma goyoo tee.

$$\begin{array}{r} 45 + 52 = 97 \\ \\ 45 \\ + 52 \\ \hline = 97 \end{array}$$

Alfagaa m'i hãa, marje no i duu ? Marje ti iwoy boŋ nda affowey hinnaa ?

Denden : Kabey wey tee.

$$\begin{array}{r} 67 \qquad 59 \qquad 46 \qquad 72 \qquad 81 \qquad 94 \\ + 31 \qquad + 39 \qquad + 50 \qquad + 27 \qquad + 10 \qquad + 5 \\ \hline = \qquad = \qquad = \qquad = \qquad = \qquad = \end{array}$$

Goy hinkantoo : Bonhaw : Ali koy saajoo ra, a na garbay 98 kaa kaŋ a yee kate hugey do, a na garbay 35 zamni kayney game. Garbay marje ka cindi Ali kone ?

Laasaabu :

- Garbay marje no Ali duu ey saajoo ra ?
- Marje no a na kayney noo ?
- Macin no bonhawoo nee ir m'a ceeci ?
- Kabu sii foo no ma tee ?
- Hinna foo ma hun hinna foo ra ?

Alfagaa ma nee i ma kaboo hantumoo tee.

$$\begin{array}{r} 98 - 35 = 63 \qquad 98 \\ \\ - 35 \\ \hline = \end{array}$$

Denden : Kaayaney wey tee.

$$\begin{array}{r} 92 \qquad 97 \qquad 98 \qquad 94 \qquad 96 \qquad 99 \\ - 21 \qquad - 48 \qquad - 37 \qquad - 19 \qquad - 56 \qquad - 90 \\ \hline = \qquad = \qquad = \qquad = \qquad = \qquad = \end{array}$$

Denden

1. Kabey wey hantum m'i timmandi.

| | | | | | |
|------|------|------|------|------|------|
| 42 | .. | 63 | 63 | 91 | 80 |
| + 6 | + 73 | + .. | + 29 | + 7 | + 16 |
| = 98 | = 97 | = 92 | = .. | = .. | = .. |
| 50 | 98 | | | | |
| + 48 | + . | | | | |
| = | = | | | | |

2. Kabey wey hantum m'i tee.

| | | | | | |
|------|------|------|------|------|------|
| 99 | 96 | 92 | 99 | 98 | .. |
| - 64 | - 22 | - 58 | - .. | - .. | - 36 |
| = | = | = | = | = | = |

3. Kabey gorandi m'i tee.

$45 + 52 =$; $62 - 34 =$; $64 + 35 =$; $57 + 40 =$;
 $36 + 58 =$; $93 + 46 =$; $99 - 92 =$; $96 - 48 =$; $95 - 26 =$

4. Bonhaw : Taalibi aru 65 nda woy 32 goo cawhugu foo ra.

Taalibi marje ma bara cawhugoo ra ?

5. Waatoo kan siisihyoo ga tun Tunbutu, boro 40 ka huru a ra. Diirey a na boro 30 zaa, Tonka ra a na boro 10 zaa, Jlafunke ra, boro 19. Boro marje ka huru siisihyoo ra ?

6. Mamadu baaba hun yooboo ra nda bonbon 95 . A na bonbon 40 zamni nga zankey game. Bonbon marje ka cindi Mamadu baaba kone ?

7. Aysata koy yooboo ra nda kaatibi 97. A na kaatibi 54 ka day-day. Kaatibi marje ka cindi Aysata kone ?

Caw : 100 hinnaa

Taasiha : Taaliboo ma hin :

- ka margari-izey hinnaa bay margari ra ;
- ka 100 margari cin, ka 100 caw, k'a hantum nda kabu-ize nda harfu ;
- ka hinnawey hanga-hangandi cere bande ka hun 0 ka koy 100 nda ka hun 100 ka kaa 0 ;
- ka hinnawey durse ka hun 1 ka koy 100.

Goyjinawey : Wey kan goo sunduku sukantaa ra.

Goyey

Goy jinaa : Alfagaa ma nee taalibey ma bundu-ize 90 margari tee nda iwoy bon 9 nda bundu-ize 9. A m'i haa : « bundu-ize marje no » ? A ma yee ka nee taalibey ma bundu-ize 1 sanbu, i m'a tonton margaroo ga. A ma nee i se : « Iwoy bon marje nda bundu-ize marje no i duu sohō ? (iwoy bon 10). » Alfagaa ma nee : « Woo ti 100. » Taalibey m'a har.

Goy hinkantoo : Alfagaa ma goyoo biyoo tee walhabeeroo ga, taalibey mo m'a tee.

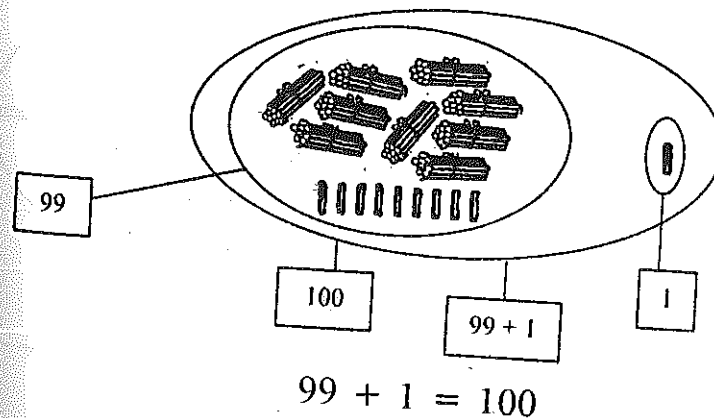

Alfagaa ma woo hantum :

= 100

ey ma zangu caw, i m'a hantum nda kabu-

ndi-ize zaa, ma goy follokaa tee nd'ey, ma

: Wa hinnawey hanga-hangandi cere bande

ka koy ibeeroo ga :

0 ; 10 ; 80 ; 40 ; 60 ; 20.

: Kabu nda 5-5 ka hun 0 ka koy 100 . Kabu

0 ka koy 100, nda ka hun 100 ka doo 0.

da 5-5 ka hun 50 ka koy 100.

da 10-10 ka hun 0 ka koy 100.

da 5-5 ka hun 100 ka doo 80.

mmandi.

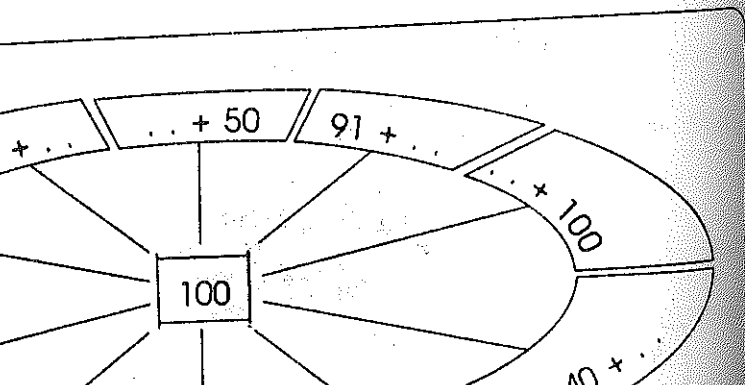

Denden

1. Hantumey wey berandi m'i timmandi.

| | | | | | | | |
|-------|-------|-----|-----|--|--|--|--|
| 100 | 100 | 100 | 100 | | | | |
| zangu | zangu | | | | | | |

2. Zuwey wey tee m'i timmandi.

| | | | | | | | | | |
|------|------|------|------|-----|-----|-----|-----|-----|-----|
| 55 ; | 60 ; | 65 ; | 70 ; | --- | --- | --- | --- | --- | 100 |
|------|------|------|------|-----|-----|-----|-----|-----|-----|

| | | | | | | | | | |
|----|-----|-----|-----|-----|--|--|--|--|-----|
| 0, | 20, | 40, | --- | --- | | | | | 100 |
|----|-----|-----|-----|-----|--|--|--|--|-----|

| | | | | | | | | | |
|------|-----|-----|-----|-----|-----|-----|-----|-----|----|
| 100, | 98, | 96, | --- | --- | --- | --- | --- | --- | 80 |
|------|-----|-----|-----|-----|-----|-----|-----|-----|----|

3. Daaroo tee ma goyoo timmandi.

| | |
|-----|----------|
| 10 | Iwoy |
| 40 | Woytaaci |
| 80 | ----- |
| 100 | ----- |
| 30 | ----- |

Filla : 100 ga

Alfagaa ma nee taalibey ma dendeney wey tee.

Denden

- Hinnawey kul hantum ka hun 85 ka koy 100.
- Hinnawey hantum ka hun 50 ka koy 100, cee foo kul ma 5 tonton.
- Hinnawey deedandi nda <wala> wala =
38 nda 68 ; 90 nda 30 ; 89 nda 98 ; 100 nda 10 ;
55 nda 45 ; 77 nda 66 ; 49 nda 94 ; 72 nda 92.
- Goyoo tee m'a timmandi.
- Daaroo tee m'a timmandi.

| | | |
|-----|----------|----------------|
| 10 | Iwoy | Iwoy boj foo |
| 40 | | |
| 80 | woyyaaha | Iwoy boj yaaha |
| 100 | | |
| 30 | | |

6. Kabey wey hantum, m'i timmandi :

$$\begin{array}{r}
 42 \quad .6 \quad 25 \quad 4. \quad .. \quad 63 \\
 +.6 \quad +.0 \quad +.. \quad +31 \quad +73 \quad +.. \\
 \hline
 = 98 \quad = 76 \quad = 88 \quad = 74 \quad = 97 \quad = 100 \\
 \\
 8. \quad 49 \\
 +15 \quad +.. \\
 \hline
 = 100 \quad = 100
 \end{array}$$

5. Hinnawey hanga-hangandi cere bande ka hun i kul ikaccaa ga ka koy ibeeroo ga :

90, 93, 97, 91, 96, 99, 92, 95, 98.

6. Hinna follokey hanga-hangandi cere bande ka hun i kul ibeeroo ga ka doo ikaccaa ga.

7. Zuwey wey tee, m'i laasaabu, m'i timmandi.

| | | | | | |
|----|----|----|----|----|----|
| 90 | 92 | 94 | .. | .. | .. |
|----|----|----|----|----|----|

| | | | | |
|----|----|----|----|----|
| 91 | 93 | .. | .. | .. |
|----|----|----|----|----|

8. Woo berandi, m'a timmandi.

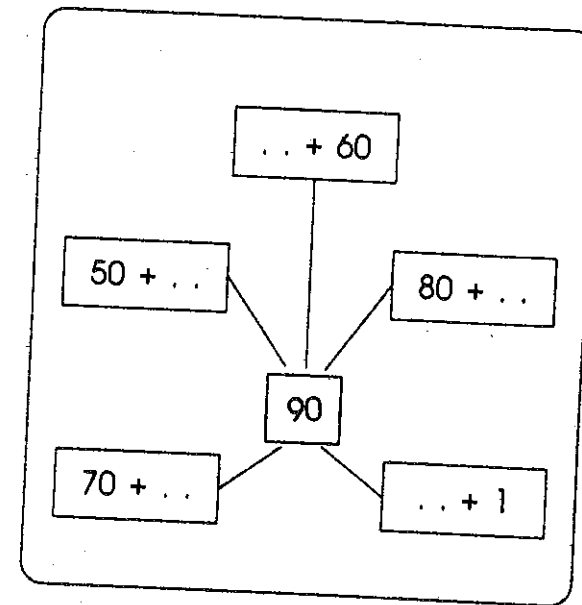

7. Kabey wey suka m'i tee.

$$99 - 64 = \dots ; 66 - 22 = \dots ; 100 - 42 = \dots ; \dots - 35 = 65 ;$$

$$76 - 42 = \dots ; 100 - \dots = 38.$$

8. Hinna 3 nda hinna 4 nda hinna 5 margari tee kaɗ margaroo ga sawa nda 100.

9. Wey timmandi nda $<$, $>$ wala $=$.

| | | |
|-------------------|--------------------|-----------------------|
| $37 \dots 73$ | $50 + 50 \dots 99$ | $100 \dots 50 + 50$ |
| $50 \dots 65$ | $79 \dots 60 + 19$ | $60 + 16 \dots 76$ |
| $48 \dots 40 + 8$ | $98 \dots 80 + 8$ | $90 + 1 \dots 90 + 9$ |

10. Woo timmandi.

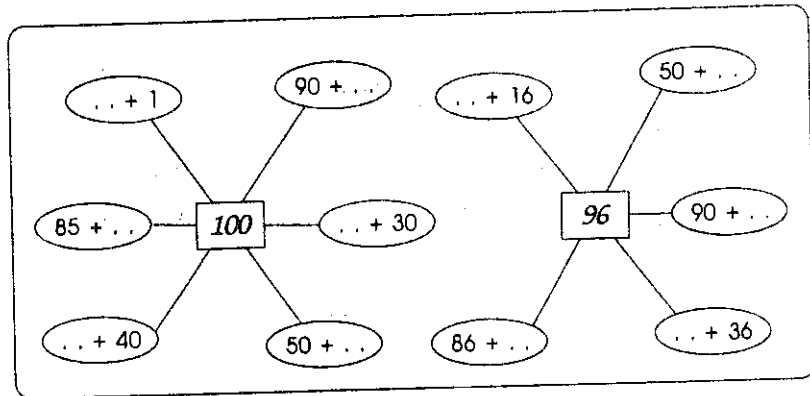

Caw : 100 fesu-fesuyan

Taasiha : Taaliboo ma hin :

- ka 100 fesu-fesu.

Goyjinawey : Wey kaɗ goo sunduku sukantaa ra.

Goyey

Goy jinaa : Alfagaa ma nee taalibey se i ma 100 cin nda 50 margari hinka. A m'i hãa : « 50 margari marje ma bara 100 ra ? »

Marje ka tonton 50 ga ka duu 100 ?

Goy hinkantoo : Alfagaa ma yee ka nee taalibey ma 60 margari tee. A m'i hãa : « Margari marje ma hima ka tonton a ga ka duu 100 ? »

Alfagaa ma kate taalibey ma laasaabu kaɗ 100 ti : $40 + 60$

Denden

1. Duu hinnawey kaɗ ga kuma.

$$100 = 80 + \dots ; 100 = 65 + \dots ; 100 = 48 + \dots ;$$

$$100 = 95 + \dots ; 100 = 39 + \dots ; 100 = 56 + \dots ;$$

$$100 = \dots + 15.$$

2. Kabey wey hantum m'i timmandi.

$$50 + \dots = 100 ; 43 + \dots = 100 ; \dots + 69 = 100 ;$$

$$\dots + 99 = 100 ; 91 + \dots = 100 ; 11 + \dots = 100 ;$$

$$41 + \dots = 100 ; 70 + \dots = 100 ; \dots + 77 = 100.$$

3. Kabey wey timmandi.

$$100 = 10 \text{ marje ? - - -}$$

$$100 = 20 \text{ marje ? - - -}$$











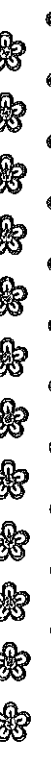

4. Wey hantum, m'i timmandi.

$$100 = 40 + \text{ - - - } + \text{ - - - } + \text{ - - - }; \quad 25 + \text{ - - - } + 39 = 100$$

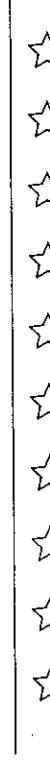
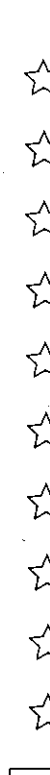
$$100 = 30 + \text{ - - - } + 40; \quad 18 + 56 + \text{ - - - } = 100$$

$$100 = \text{ - - - } + 24 + 48 + 7; \quad 5 + \text{ - - - } + 33 + 19 + \text{ - - - } = 100$$

5. Wey timmandi nda <, > wala =.

| | | | | | | | | | | | | | | |
|--|--|--|--|--|--|--|--|--|--|--|--|--|---|--|
|  |  |  |  |  |  |  |  |  |  |  |  |  |  |  |
| <input type="text"/> | <input type="text"/> | <input type="text"/> | <input type="text"/> | <input type="text"/> | <input type="text"/> | <input type="text"/> | <input type="text"/> | <input type="text"/> | <input type="text"/> | <input type="text"/> | <input type="text"/> | <input type="text"/> | <input type="text"/> | <input type="text"/> |

DOOBAYRAY

Caw : Jine – banda

Taasiha : Taaliboo ma hin :

- ka jine bay a ma banda bay ;
- ka jinay jisi affoo tana jine wala banda ga.

Goyjinawey : Taalibey, taabaley, tiirawey, hkh.

Goyey

Goy jinaa : Alfagaa ma taalibey hãa nda hayey kaŋ i ga dii ey ngi jine, nda wey kaŋ goo dumawey ga (i m'i cebe) sanda : jine here : walhabeeroo, gorohayaa, hkh ; banda here : sunduku sukantaa, cawdeegarey, biyey, hkh.

Goy hinkantoo : Alfagaa ma nee taalibi foo ma koy kay cerey jine, a ma koy, a ma kaa goyoo ga nda taalibi tana fooyaŋ.

Goy hinzantoo : Alfagaa ma nee taalibi foo ma koy kay cerey se banda ; a ma koy a ma kaa goyoo woo ga nda taalibi tana fooyaŋ.

Goy taacantoo : Alfagaa ma nee taalibi foo kul ma jinay foo jisi nga boŋ jine.

Goy guwantoo : Alfagaa ma nee taalibi foo kul ma jinay foo jisi nga boŋ banda ga.

Goy idduwantoo : Alfagaa ma nee taalibi foo se, a ma koy kay taabaloo, wala ganboo, wala sund...

Goy iyyantoo : Alfagaa ma nee taalibi foo se, a ma koy nga walhaa jisi biibataa bandaa ga wala jinoo ra. Alfagaa ma goyoo filla nda taalibi fooyan ; a ga jinawey barmay-barmay.

Goy yaahantoo : Alfagaa ma nee taalibey ma duu himakasinayyan nonguyan ra kan man'ti cawhugoo gundoo waney.

Denden

1. Taalibey ma bugu tee, alfagaa ma nee taalibey ma tammaasa dam bugoo jine.
2. Taalibey ma zeeri ciray tee, i ma zeeri kaaray dam bandaa ga.
3. Bugu foo tee, ma tuuri dam a jine.

N.B : Alfagaa ma kookari jinay kul masi bara taabaley bog cawoo sintinoo ga.

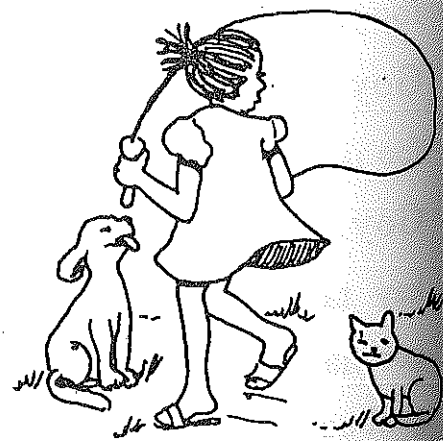

Caw : Kanbe guma* – kanbe wowa*

Taasiha : Taaliboo ma hin :

- ka nongu guma nda nongu wowa bay nga bon ga ;
- ka boro foo tana nongu gumaa nda nga nongu wowaa fay k'i kaa cere ra ;
- ka haya jisi affoo tana ceraw gumaa wala ilaalaa here.

Goyjinawey : taalibey, bal.

Goyey

Goy jinaa : Alfagaa ma kay wallabeeroo jeroo ga, a ma banda fur zankey se, a ma nga kanbe gumaa cebe i se, a ma filla ka nga kanbe wowaa mo cebe i se. A ma nee taalibey se : wa war kanbe gumawey jer, wa war kanbe wowey jer.

Goy hinkantoo : Alfagaa ma nee taalibi foo ma baloo kar nda nga cewoo ; a ma hãa wala cee foo nda a na baloo kar.

Goy hinzantoo : Alfagaa ma wiri taalibi foo kul ga, a ma nongu cebe nga jere gumaa ra wala nga jere laalaa ra. A ma taalibey hãa wala kanbe foo nda ngi hunday ga bii tee, wala cee foo nda i ga bal kar.

Goy taacantoo : Taalibi foo ma kanbe gumaa wala cee gumaa wala haya tana cebe nga cere foo ga kan ga duma tee a se.

Goy guwantoo : Alfagaa ma zankey kul kayandi, a ga nee i se : iwoy, igum. Taalibey ga cewey wala kanbey jer alfagaa senney bande.

Goy idduwantoo : Taaliboo ma zeeri foo tee, a ma windira tee kanbe gumaa nda ilaalaa here.

Denden

1. Tuuri foo tee, ma zeeri foo dam ceraw gumaa here, ma zeeri hinka dam ceraw wowaa here.
2. Bal foo tee ma tammaasa dam ceraw gumaa here.
3. Ni kanbe wowaa biyoo tee.
4. Bugu bii tee, ma tinda bii tee kanbe wowaa here.
5. Soo bii tee ma poti bii tee kanbe gumaa here.

Kalima sendey :

Kanbe guma : Kanbe borya.

Kanbe wowa : Kanbe laala.

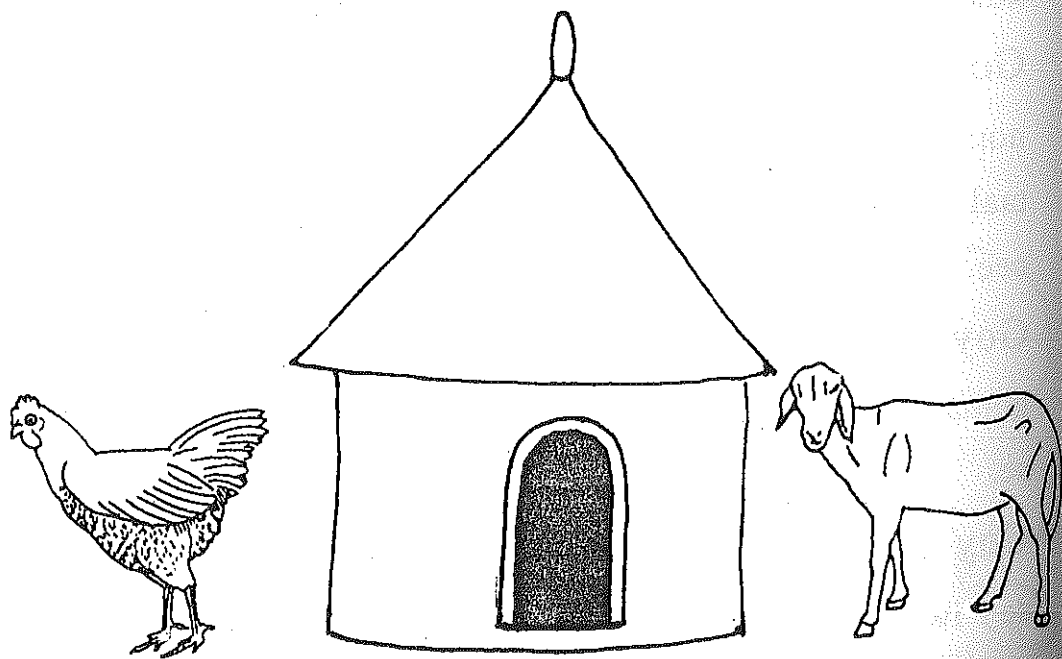

Caw : Kuna/ra – taray

Taasiha : Taaliboo ma hin :

- ka bay wala jinay goo kuna wala taray ;
- ka huru kuna wala ka fatta taray ;
- ka jinay dam kuna wala taray ;
- ka windi kuna wala taray bay ;
- ka haya kul kunaa wala taraa bay.

Goyjinawey : karfu, kusu, soo, hari, feraw, tondi-ize, tiira, baaji, kalam, ziiba, nooru, hkh.

Goyey

Goy jinaa : Alfagaa ma jinay daabantayan fur taabaloo ga. A m'i cebe taalibey se. (kusu, baaji, soo). A ma tondi-ize dam kusoo ra. Alfagaa ma taalibi foo hãa wala man ra tondi-izoo goo. (kusoo ra, gundoo ra). A ma takaa woo da tee nda taalibi fooyan.

Goy hinkantoo : Alfagaa ma nee taaliboo ma tondi-izoo kaa kusoo ra. A m'a hãa wala man ra a goo kusoo se (taray). A ma takaa woo da tee nda taalibi fooyan.

Goy hinzantoo : Alfagaa ma taalibiyay cee, i ma kali tee. Taalibi foo ma huru kaloo ra. Alfagaa m'a hãa wala man ra a goo (kaloo ra). Alfagaa ma nee taaliboo se a ma fatta kaloo ra. A m'a hãa wala man ra a goo (taray). Alfagaa ma takaa woo da tee nda taalibi fooyan.

Goy taacantoo : Alfagaa ma windira foo tee laboo ga. A ma nee taalibiyay se i ma huru a ra. A ma nee affooyay se i ma yee taray. A ma taalibi foo kul hāa nda nga dogoo windiraa se.

- Alfagaa ma yee ka nee taalibey se, i ma tondi-ize jisi windiraa kuna wala a se taray.

Goy guwantoo : Alfagaa ma taalibi foo sanba a ma windira foo tee walhabeeroo ga. Taaliboo ma zeeri foo tee windiraa gundoo ra, a ma zeeri hinka tee windiraa se taray. Alfagaa ma taalibi booboyay sanba, i ma takaa woo da filla.

Goy idduwantoo : Alfagaa ma taalibi foo sanba walhabeeroo do. A ma windira foo tee, a ma gundoo noone. Alfagaa ma takaa woo filla nda taalibi booboyay.

Denden

1. Zeeri daabante foo tee, ma koli foo dam a kuna.

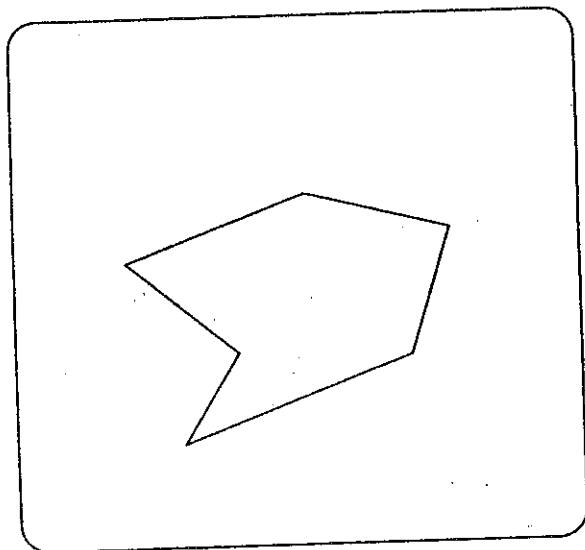

2. Zeeri daabantaa woo tee, ma X tee a se taray.

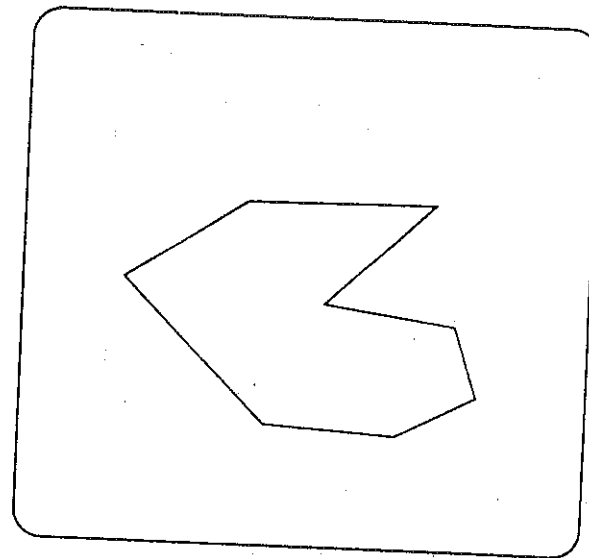

3. O tee kaarewoo woo se taray.

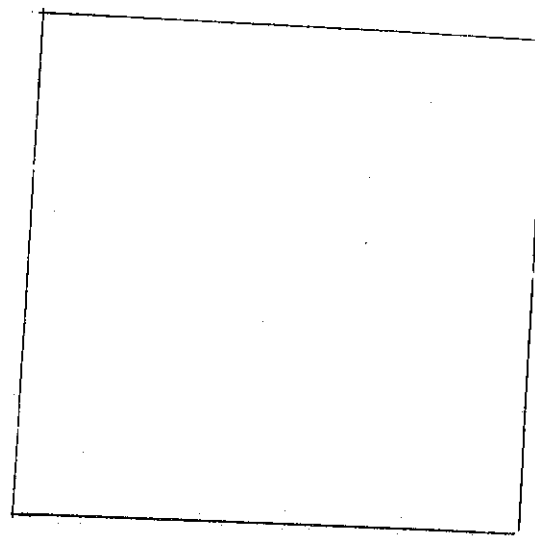

woo kuna.

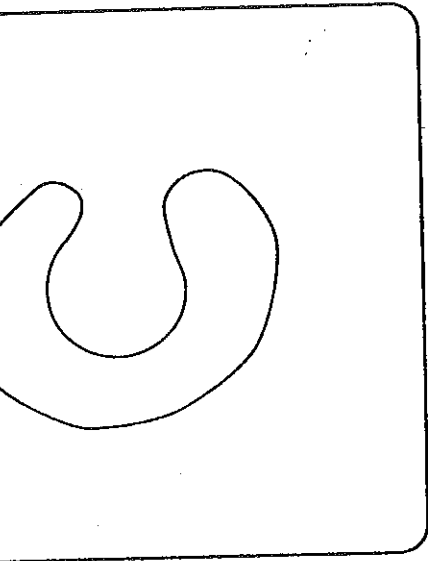

aaabantey wey kuna.

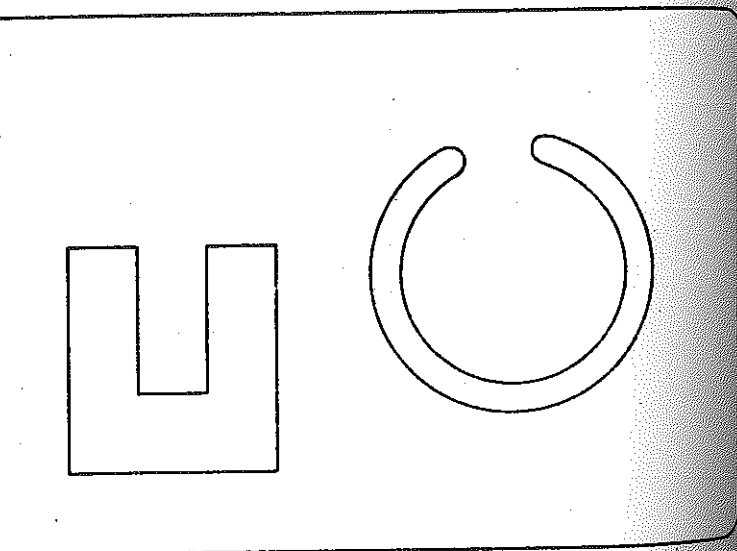

a kanjehinza foo tee a kuna.

Caw : Beene – ganda ; beene here – ganda here

Taasiha : Taliboo ma hin :

- ka haya beene heroo nda ganda heroo bay ;
- ka haya cebe kanj goo affoo tana se beene wala a se ganda.

Goyjinawey : Taalibey, alfagaa, walhawey, walhabeeroo, tiira, kalam, baaji, galankaaru.

Goyey

Goy jinaa : Alfagaa ma nee taalibey ma sunduku sukantaa beene heroo cebe i ma nga ganda heroo cebe. Alfagaa ma nee i m'a filla nda jinay foo tanayanj : walhabeeroo, taabaloo, biibataa, alfagaa gorohayaa.

- Alfagaa ma nee taalibey ma jinay foo tanayanj beene herey cebe i ma ngi ganda herey cebe.

Goy hinkantoo : Alfagaa ma nee taalibey se i ma ngi walhawey suka. I ma walhawey beene herey nda ngi ganda herey cebe.

Goy hinzantoo : Taalibey ma gunguli tee walhabeeroo beene heroo ga, i ma kaare tee walhabeeroo ganda heroo ga.

Goy taacantoo : Alfagaa ma nee taalibey ma duu ngi himakasineyanj nonguyan ra.

Goy idduwantoo : Alfagaa ma taalibi foo sanba

Denden

1. Bugu tee, ma zeeri foo tee a se beene, ma zeeri hinka tee a se ganda.

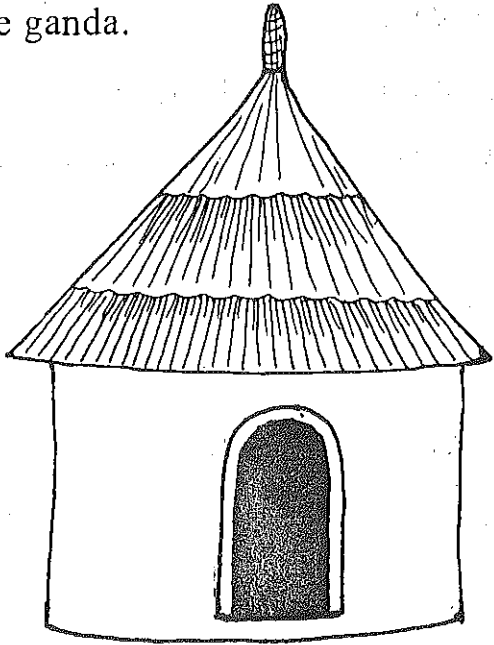

2. Kaare hinka tee kaŋ goo cere boŋ. Gunguli tee woo kaŋ goo beene boŋ, ma zeeri tee woo kaŋ goo ganda cire.

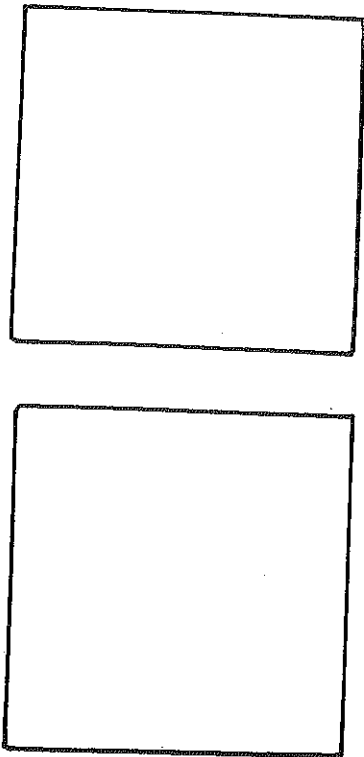

3. Zeeri tee. Kusu tee a se beene, ma hamiisa tee a se ganda.



4. Tuuri tee kaŋ ciraw foo g'a boŋ, hayla g'a cire.

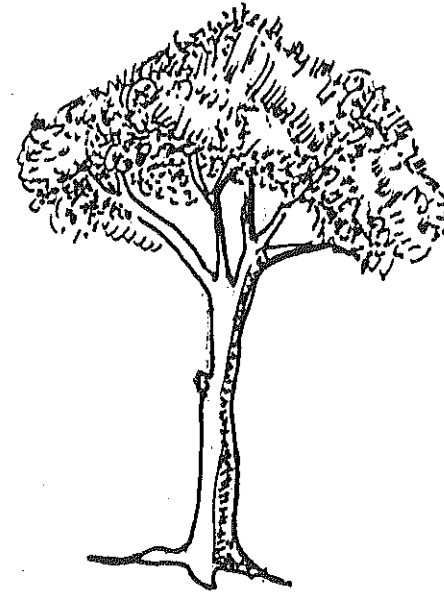

5. Moobil tee, ma gunguli foo dam a se beene, ma X dam a se ganda.

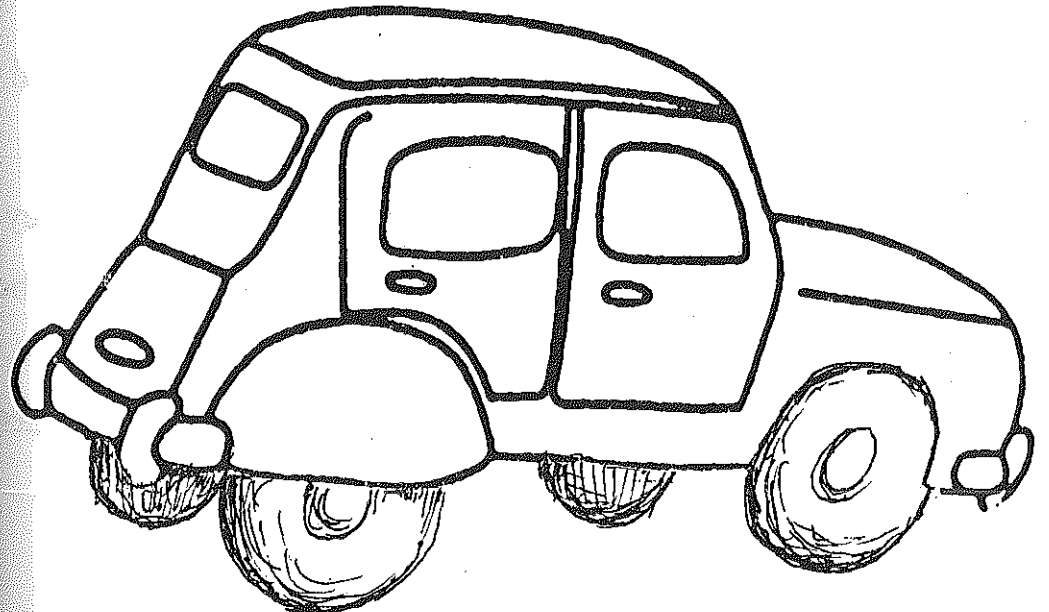

Sanda :

| | |
|---|---|
| i | a |
| 5 | 3 |
| 3 | 5 |

- alfagaa ma nee taalibey ma duu hinna foo kul iwoy boŋoo nda nga affowaa : 0 ka koy 59 ga ; a m'i hantum kabu-ize nda harfu ra sanda iwoy boŋ 5 nda affowey 6 ga hantumandi 56 wala woyguu cindi iddu ;
- alfagaa ma nee taalibey ma hinnaa fesu-fesu nda alhaaloo woo : $50 + 1$. I ma hantum $50 + 1 = 51$ wala $1 + 50 = 51$.

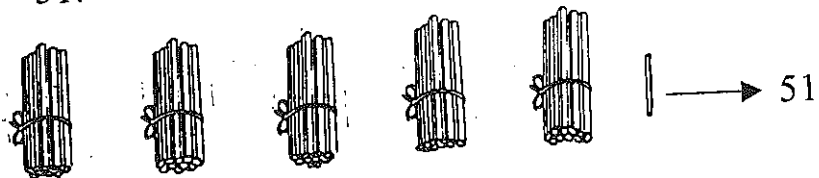

Goy taacantoo : 0 ka koy 59 hinnawey deedandi. Deedandoo ga hin ka tee nda taka hinka.

- Ijinaa : 51 ga jin 58 se, saa din 51 kacca nda 58, boro ga hantum $51 < 58$ wala $58 > 51$;
- Ithinkantoo : kabu-ize foo alkadaroo hinna ra :
 - a. Hinnawey kaŋ iwoy boŋey ga fay, sanda ka 49 nda 53 deedandi.
Hinna beeroo ti woo kaŋ goo nda iwoy boŋ beeroo ; maanaa $53 > 49$ wala $49 < 53$.
 - b. Hinnawey kaŋ goo nda iwoy boŋ follokaa amma affowey ga fay-sanda ka 54 nda 57 deedandi.

Hinna beeroo ti woo kaŋ goo nda affowey beeroo ; maanaa $57 > 54$ wala $54 < 57$.

Goy guwantoo : 0 ka koy 59 hinnawey hangandi cere bande sanda ka 26, 21, 18, 51, 34, 7, 49, 44, 57 hantum cere bande ka ziji, ka zunbu. Kabu 1 ka koy 59 nda 59 ka yee 1 ga.

Denden

1. Wey berandi, m'i timmandi :

| | |
|---------------------|----|
| 51, | 51 |
| woyguu cindi foo, | |
| 54, | 54 |
| woyguu cindi taaci, | |

2. Biyoo tee ma daaroo timmandi.

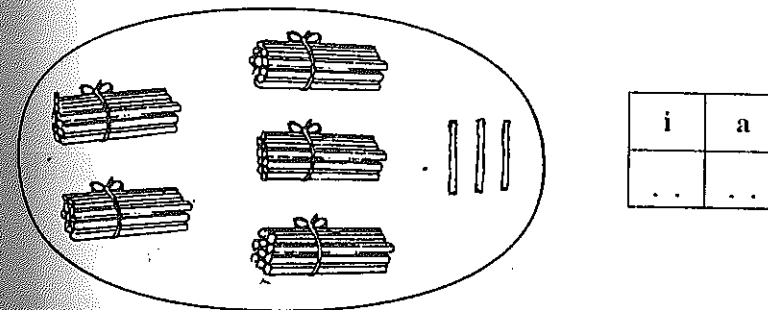

3. Daaroo tee m'a timmandi.

| | |
|----|--------------------|
| 52 | |
| .. | Woyguu cindi hinza |
| 54 | |
| 59 | |

Sanda :

| | |
|---|---|
| i | a |
| 5 | 3 |
| 3 | 5 |

- alfagaa ma nee taalibey ma duu hinna foo kul iwoy boŋoo nda nga affowaa : 0 ka koy 59 ga ; a m'i hantum kabu-ize nda harfu ra sanda iwoy boŋ 5 nda affowey 6 ga hantumandi 56 wala woyguu cindi iddu ;
- alfagaa ma nee taalibey ma hinnaa fesu-fesu nda alhaaloo woo : $50 + 1$. I ma hantum $50 + 1 = 51$ wala $1 + 50 = 51$.

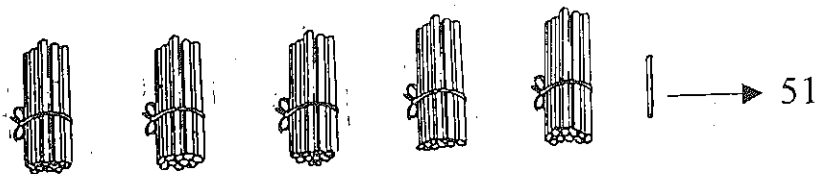

Goy taacantoo : 0 ka koy 59 hinnawey deedandi. Deedandoo ga hin ka tee nda taka hinka.

- Ijinaa : 51 ga jin 58 se, saa din 51 kacca nda 58, boro ga hantum $51 < 58$ wala $58 > 51$;
- Ithinkantoo : kabu-ize foo alkadaroo hinna ra :
 - Hinnawey kaŋ iwoy boŋey ga fay, sanda ka 49 nda 53 deedandi.
Hinna beeroo ti woo kaŋ goo nda iwoy boŋ beeroo maanaa $53 > 49$ wala $49 < 53$.
 - Hinnawey kaŋ goo nda iwoy boŋ follokaa amma affowey ga fay-sanda ka 54 nda 57 deedandi.

8. Wey hantum m'i timmandi.

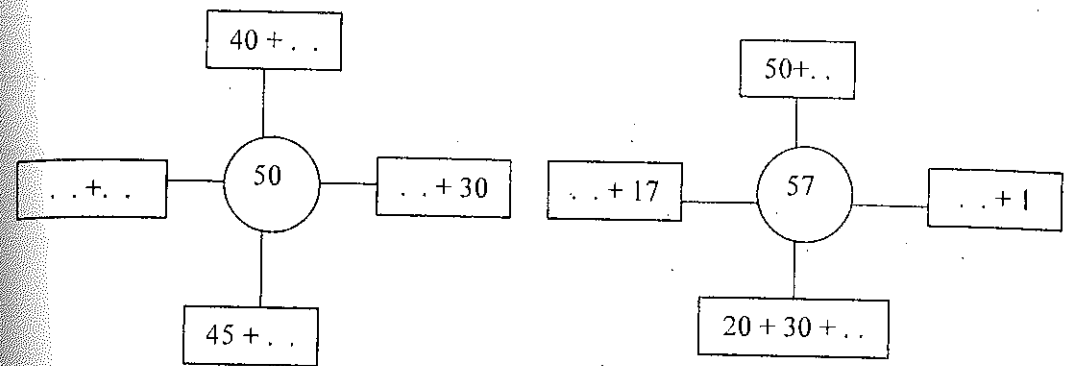

9. Wey berandi, m'i marga nd'iwoy-woy ma hinnaa kaŋ i sawa nd'a hantum.

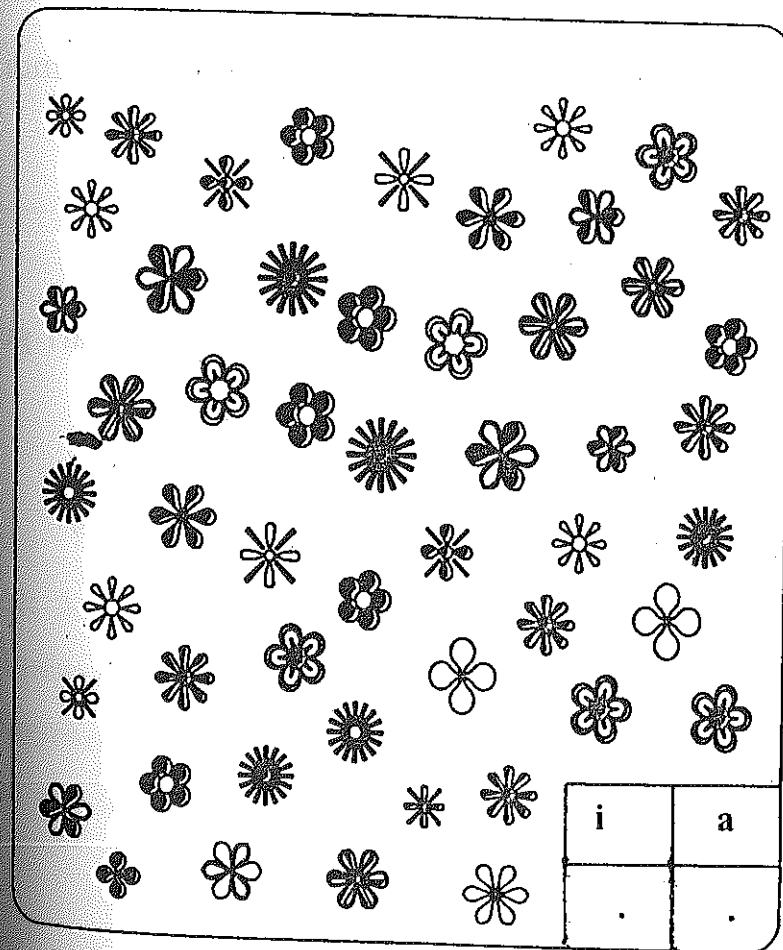

Caw : Kaayan kan goo nda lanbari 50 ka koy 50

Taasiha : Taaliboo ma hin :

- ka kaayan mise bay ;
- ka kaayan tee kan goo nda lanbari.

Kabu cahante :

Wa kabu nda ihinka-hinka

- ka hun 0 hala 30 ;
- ka hun 20 hala 50 ;
- ka hun 50 ka yee 30.

Goyjinawey : goyjinawey kan ga duwandi.

Goyey

Bonhaw : Fanta goo nda teenay-ize 22.



A na Muusa noo teenay 9. Teenay marje ka cindi Fanta se ?

Kaboo daaru m'a timmandi

$$22 - 9 = \dots ?$$

Laasaabu : Nda n'ga baa ma kaayan tee kan ra lanbari goo, n'ga fondawey affoo gana.

| i | a |
|-------|------|
| 2 | 2 |
| - 1 | + 10 |
| ----- | |
| | 9 |
| 1 | 3 |

Fondo 1^{ntoo} :

Marje no i g'a tonton 9 ga ka duu 22 ?

$$\begin{aligned}
 & 22 \\
 & + 9 = 22 \\
 & \quad + 9 \\
 & = 22
 \end{aligned}$$

| i | a |
|-------|------|
| 2 | 2 |
| - 1 | + 10 |
| ----- | |
| | 9 |
| 1 | 3 |

Fondo 2^{ntoo} :

- Affowey sorraa ra, ni mma hima ka 9 kaa 2 ra.

Woo binde si hin ka tee.

Saa din ni mma iwoy tonton ihinka ga duu 12 ; sohō n'ga 9 kaa 12 ra, a ga cindi 3.

- Iwoy sorraa : iwoyaa din mma hantumandi iwoyey sorraa ra 2 cire. Ma nee 1 kan hun 2 ra, a ga cindi 1.

$$\text{Zaaboo : } 22 - 9 = 13$$

Fondo 3^{ntoo} :

- Affowey sorraa ra, ni mma hima ka 9 kaa 2 ra.

Woo si hin ka tee.

Adisi ni mma iwoy bon foo kaa 2 ra iwoy sorraa ra. Iwoyaa din m'a tonton 2 ga ka duu kabu-ize 12.

Sohō ma 9 kaa 12 ra, a ga cindi 3.

$$\text{Zaaboo : } 22 - 9 = 13$$

Denden

1. Ali koy nda takula 43 yooboo ra. Takula 29 day a se fondaa ra. Takula marje nda Ali too yooboo ra ?
2. Koyraa woyey na karfu day kan ga sawa nda meetar 46. I na meetar 28 dunbu karfoo ra. Meetar marje ka cindi i se ?

3. Amadu goo nda jiiri 50. Arhamatu goo nda jiiri 25. Jiiri marje nda Amadu zen Arhamatu ?
4. Taalibi 57 bara cawhugu jinaa ra. Woyey ga sawa nda 39. Marje ti arey hinnaa ?
5. Mufuliha na saaku 42 hegay nga faaroo ra. A na saaku 9 ka garaw bana. Saaku marje ka cindi a se ?
6. Muusa duu kilo 43 ɲaari ngi kondaa ra. A na kilo 28 noo armaa se. ɲaari kilo marje ka cindi Muusa se ?

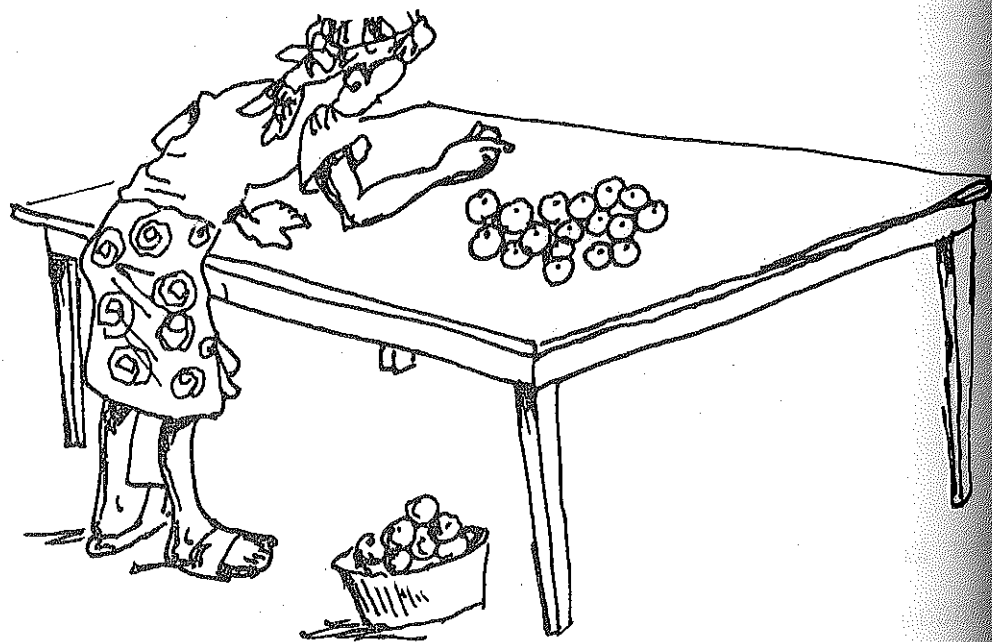

Caw : 60 hinnaa

Taasiha : Taaliboo ma hin :

- ka margari-izey hinnaa kaɲ goo margari ra bay ;
- ka margari cin kaɲ ga sawa nda 60 ;
- ka 60 caw, k'a hantum nda kabu-ize nda harfu ;
- ka 60 cin, k'a fesu-fesu.

Kabu cahante

- Kabu nda igguu-guu : 0 ka koy 55 hinnawey.
- Kabu nda iwoy-woy : 0 ka koy 50 hinnawey.

Goyjinawey : Bundu-ize, tondi.

Goyey

Goy jinaa : Alfagaa ma nee taalibey ma bundu-ize 59 kabu.

W'i kanandi nd'iwoy-woy.

Iwoy boɲ marje bara a ra ? Bundu-ize marje ka cindi ?

59 ga sawa nda iwoy boɲ guu nda bundu-ize 9.

Goy hinkantoo : Alfagaa ma nee taalibey ma bundu-ize foo tonton bundu-ize 9 ga.

Alfagaa m'i hãa : « iwoy boɲ marje no ? »

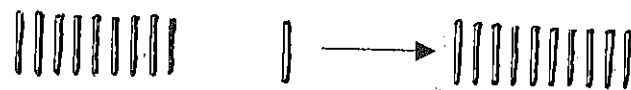

$$9 + 1 = 10$$

Goy hinzantoo

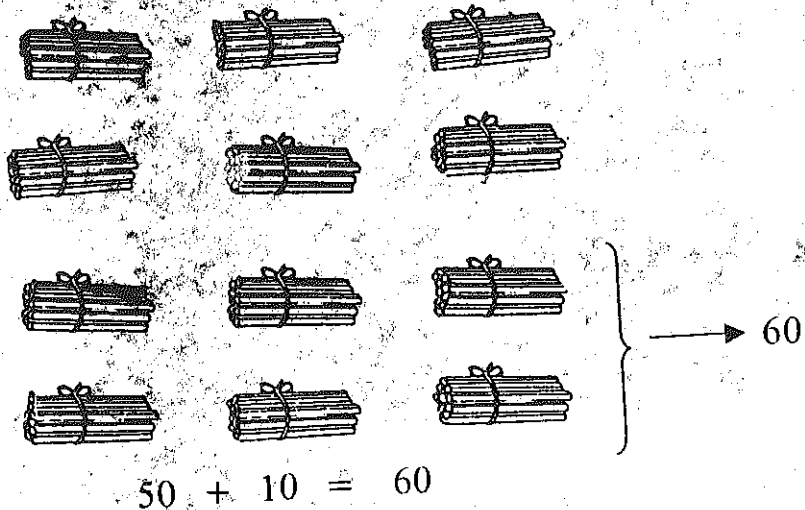

Nda iwoy boŋ foo tonton iwoy boŋ guwaa ga, iwoy boŋ marje no? Iwoy boŋ iddu.
Iwoy boŋ iddu hantum daaroo ra.

| Iwoyey | Affowey |
|--------|---------|
| --- | --- |

$50 + 10 = 60$

- Alfagaa ga 60 hantum nda kabu-ize, a g'a caw, taalibey g'a har, i g'a hantum.
- Alfagaa ga 60 hantum nda harfu, taalibey m'a hantum.

Goy taacantoo : Alfagaa ga nee taalibey ma 60 cin, i m'a fesu-fesu.

$$60 = 20 + 20 + 10 + 10$$

$$60 = 40 + \dots$$

$$60 = 15 + 15 + 20 + \dots$$

$$30 + 30 = 60$$

$$10 + 10 + \dots = 60$$

$$30 + 15 + \dots = 60.$$

Denden

1. Tuuru

- Bundu-ize 60 = kabu-ize 60 wala iwoy boŋ 6
- Tondi 60 = kabu-ize 60 wala iwoy boŋ - - -
- Taalibi 60 = kabu-ize - - - wala iwoy boŋ - - -
- Walha iwoy boŋ idduu ga sawa nda walha - - -

2. Kabu nda :

- iwoy-woy : 0 ka koy 60
- igguu-guu : 0 ka koy 60
- ihinka-hinka : 0 ka koy 60.

3. Kabu nda :

- iwoy-woy : 60 ka koy 0
- igguu-guu : 60 ka koy 0
- ihinka-hinka : 60 ka koy 0.

4. 60 hantum nda harfu nda kabu-ize.

5. Hinnawey hantum ka hun 50 ka koy 60 nda 60 ka koy 49 ga.

6. Woo hantum m'a timmandi.

$$58 + \dots = 60$$

$$40 + \dots = 60$$

$$60 + 10 + \dots$$

$$\dots + 45 = 60$$

$$\dots + 30 = 60$$

$$60 = 25 + \dots + 15$$

7. Daaroo tee m'a timmandi.

| | iwoyey | affowey |
|-------------------------------|--------|---------|
| $50 + 7 =$ woyguu.cindi iyeye | 5 | 7 |
| $50 + 10 =$ | | |
| $\dots = \dots$ | 6 | 5 |
| $\dots =$ woytaaci cindi iddu | | |

8. Hinnawey hantum nda kabu-ize.

- woyguu cindi iyeye =

- woytaaci cindi yagga =

- waranza cindi iddu =

- woydu =

9. Hinnawey hantum nda harfu.

$$58 =$$

$$56 =$$

$$60 =$$

$$49 =$$

$$32 =$$

10. Kaɗ siisihyoo ga hun Gaawo taalibi 25 bara a ra. A na taalibi 15 sanbu Buram, Teemera ra a na 20 zaa. Taalibi marje ka huru siisihyoo ra ?

11. Haw kur 3 na cere kubay bangoo ga. Kur jinaa ga sawa nda haw 24. Ihinkantoo haw 17, ihinzantoo 19. Haw marje ka cere kubay bangoo ga ?

Caw : Tontonyan bila lanbari wala nda lanbari (60)

Taasiha : Taaliboo ma hin :

- ka tontonyan kaɗ sii nda lanbari tee ;
- ka tontonyan kaɗ goo nda lanbari tee.

Kabu cahante

Wa kabu iwoy nda iwoy

- 20 ka koy 60

- 60 ka yee 20

Wa kabu

$$50 + 9 =$$

$$20 + 9 =$$

$$30 + 9 =$$

Goyjinawey : goyjinawey kaɗ ga duwandi.

Goyey

Goy jinaa : Haday na lefe 27 neere, woymaa na lefe 30 neere. Lefe marje no ka neerandi ?

Bonfeeraa :

lefe hinnaa kaɗ neerandi.

$$27 + 30 = \dots \quad 27$$

$$\quad + 30$$

$$=$$



Denden

| | | | | |
|-----|-----|-----|-----|-----|
| 40 | 30 | 50 | 58 | 45 |
| +20 | +32 | +10 | + 3 | +14 |
| = | = | = | = | = |

Goy hinkantoo : Naa Taraware duu tamaati kokondo hinka, ijinaa tamaati 29 goo a ra, ihinkantoo tamaati 28.

Tamaati marje bara Naa se ?



Bonfeeraa :

Naa tammati hinnaa ti :

$$29 + 28 = \dots \quad 29$$

$$\quad \quad \quad \quad \quad \quad \quad +28$$

Denden

1. Tontonyaney wey tee.

| | | | | |
|-----|-----|-----|-----|-----|
| 36 | 19 | 44 | 32 | 19 |
| +17 | +34 | +16 | + 7 | +21 |
| = | = | = | = | = |

2. Kabey tee m'i timmandi.

| | | | |
|------|------|------|------|
| 26 | 32 | .. | 26 |
| +.. | +.. | +48 | +..1 |
| = 56 | = 60 | = 60 | = 57 |

3. Aru 35 nda woy 22 bara cawhugu foo ra. Marje ti taabaley hinnaa kaɗ goo cawhugu ra ?

4. Ali na walha foo day kaatibi 35, a yee ka kayye foo day kaatibi 25. Marje ka hun Ali ga ?

5. Lokkol foo goo nda cawhugu hinza :

- ijinaa taalibi 21 bara a ra,
- ihinkantoo taalibi 17 bara a ra,
- ihinzantoo taalibi 15 bara a ra.

Taalibi marje bara lokkoloo ra ?

6. Agaysa na takula 37 tee subbaahoo ra alaasaroo ra a na takula 22 tee koyne. Takula marje no Agaysa tee ?

7. Buuba kate hayni saaku 32 nda maatiga saaku 17, ceroo kate hommo saaku 10. Saaku marje ka kaa ?

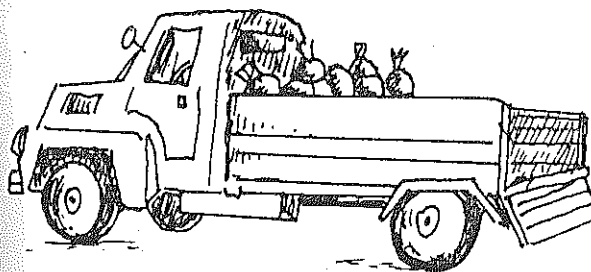

Caw : 60 ka koy 69 hinnawey

Taasiha : Taaliboo ma hin :

- ka margari-izey hinnaa kaŋ goo margari ra bay ;
- ka kun 60 ka koy 69 hinnawey caw, k'i hantum kabu-ize nda harfu ra ;
- ka jinayyaŋ kanandi nda iwoy-woy, a ma iwoy boŋey nda affowey fay, a m'i hantum ;
- ka hinnabayray goyjinawey ka hinna tana cebe ;
- ka kabu-ize foo alkadaroo bay hinna ra ;
- ka 60 ka koy 69 hinnawey fesu-fesu wala k'i cin, sanda ka iwoy boŋey nda affowey bayrandi.
- ka jinay margari tee kaŋ margari-izey hinnaa ga bayrandi ;
- ka 0 ka koy 69 hinnawey hanga-hangandi cere bande, ka kabu 1 ka koy 69 hinnawey ga.

Kabu cahante :

- kabu nda iwoy-woy hala 60 ;
- kabu nda waranka-waranka hala 60.

Goyjinawey : bundu-ize, tondi, hinnabayray goyjinawey nda goyjinawey kaŋ ga duwandi.

Goyey

Goy jinaa : Alfagaa ma nee taalibi foo kul ma :

- bundu-ize 10 hawari 5 nda bundu-ize 9 jisi nga jine, taabaloo boŋ.
- Bundu-ize 1 tonton bundu-ize 9 ga, a ma bundu-ize woyaa (10) barmay nda iwoy hawari 1.

- Alfagaa ma hantum walhabeeroo ga : 60 ; a m'a har, a m'a hantum nda harfu : woydu.

Goy hinkantoo : Alfagaa ma 61 hantum, a m'a har, taalibey m'a har a bande.

- Alfagaa ma nee taalibey ma bundu-ize 10 hawari nda bundu-ize hinnaa cebe kaŋ ga sawa nda 61. Maanaa bundu-ize 10 hawari 6 nda bundu-ize 1.

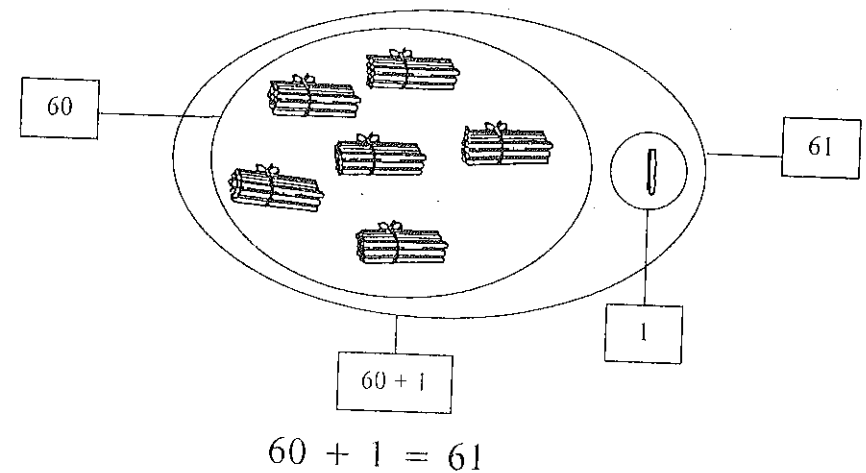

- Alfagaa nda taalibey ma yee goy follokaa ga nda hinnawey wey : 62, 63, 64, 65, 66, 67, 68, 69.

Goy hinzantoo : Alfagaa ma nee taalibey ma 61 hantum kabu-ize nda harfu ra, i m'a cebe.

- Alfagaa ma taalibey fahamandi kaŋ :
61 ra, 6 mana ti kala iwoy boŋ 6
63 ra, 3 mana ti kala affowey 3.

- Alfagaa ma kabu-ize foo kul alkadaroo fahamandi hinnawey wey ra : 0 ka koy 69 hinnawey sanda :

| | |
|---|---|
| i | a |
| 6 | 5 |
| 5 | 6 |

- Alfagaa ma nee taalibey ma duu hinna foo kul iwoy boŋoo nda nga affowaa : 0 ka koy 69 hinnawey ga, a m'i hantum kabu-ize nda harfu ra sanda iwoy boŋ 6 nda affowey 7 ga hantumandi 67 wala woydu cindi iyye.
- Alfagaa ma nee taalibey ma hinna fesu-fesu nda alhaaloo woo : $60 + 1$, i ma hantum $60 + 1 = 61$ wala $1 + 60 = 61$.

Goy taacantoo : 0 ka koy 69 deedandi hinnawey.

Deedandoo ga hin ka tee nda taka hinka.

- Ijinaa : 62 ga jin 67 se, saa din 62 kacca nda 67 ; boro ga hantum $62 < 67$ wala $67 > 62$.

- Ithinkantoo : kabu-ize foo alkadaroo hinna ra :

- hinnawey kaŋ iwoy boŋey ga fay sanda ka 54 nda 66 deedandi.

Hinna beeroo ti woo kaŋ goo nda iwoy boŋ beeroo ; maanaa $66 > 54$ wala $54 < 66$.

- Hinnawey kaŋ goo nda iwoy boŋ follokaa amma affowey ga fay, sanda ka 63 nda 69 deedandi.

Hinna beeroo ti woo kaŋ goo nda affowey beeroo, maanaa $69 > 63$ wala $63 < 69$.

Goy guwantoo : 0 ka koy 69 hinnawey hangandi cere bande sanda ka 37, 25, 44, 31, 47, 50, 69, 57, 65, 64, hantum cere bande ka ziji, ka zunbu.

- Kabu 1 ka koy 69 hinnawey nda 69 ka yee 1 ga.

Denden

- Wey berandi, m'i timmandi.

| | |
|------------------|----|
| 61, | 61 |
| woydu cindi foo, | |
| 65, | 65 |
| woydu cindi guu, | |

- Biyoo tee ma daaroo timmandi.

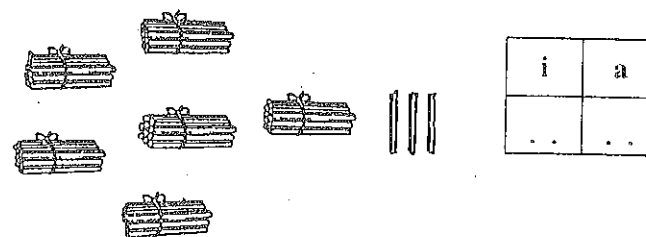

- Daaroo tee, m'a timmandi.

| | |
|----|------------------|
| 62 | ... |
| .. | Woydu cindi iyye |
| 64 | |
| 69 | |

4. Biyoo laasaabu, m'a tee, ma goyoo timmandi.

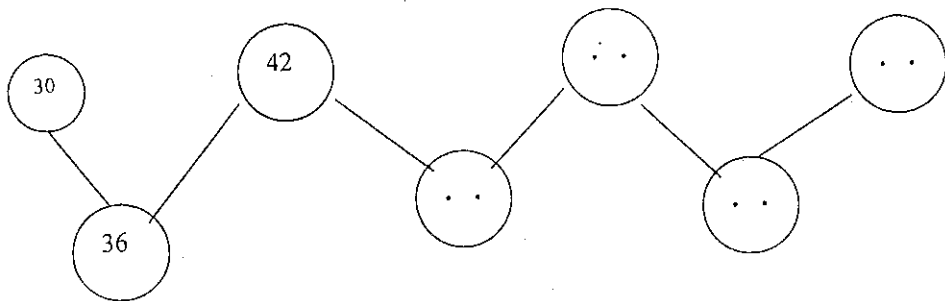

5. Daaroo tee m'a timmandi.

| | | | |
|--------------------|----|------------------------------|--------|
| ... | 53 | Iwoy boŋ ... nda affowey ... | ... |
| woydu | .. | Iwoy boŋ ... nda affowey ... | ... |
| ... | .. | Iwoy boŋ 5 nda affowey 5 | ... |
| ... | 69 | Iwoy boŋ 6 nda affowey ... | ... |
| ... | | Iwoy boŋ ... nda affowey ... | ... |
| Woytaaci cindi foo | .. | Iwoy boŋ ... nda affowey ... | 40 + 1 |
| ... | 56 | Iwoy boŋ ... nda affowey ... | ... |

6. Woo hantum, m'a timmandi.

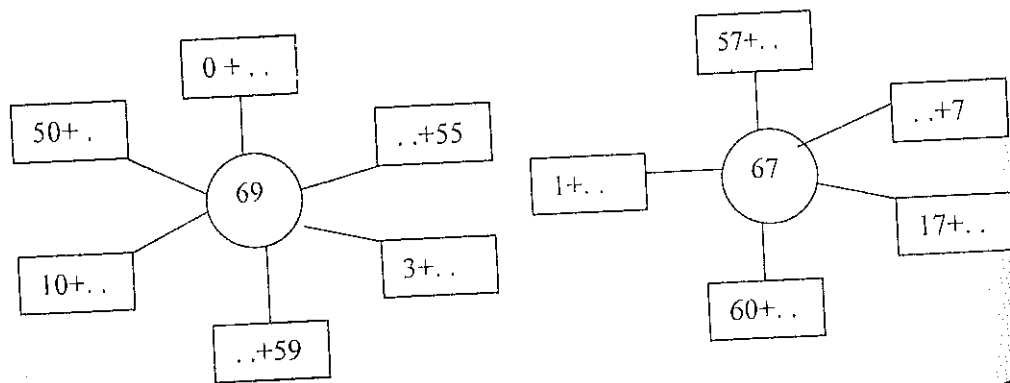

7. Hinna beeroo koli.

- a. 54 14 61
47 69 49
25 52 66

- hinna kaccaa koli.
- b. 50 + 5 60 + 4 50
50 + 1 52 49
60 + 2 65 59

8. Woo tee m'a timmandi.

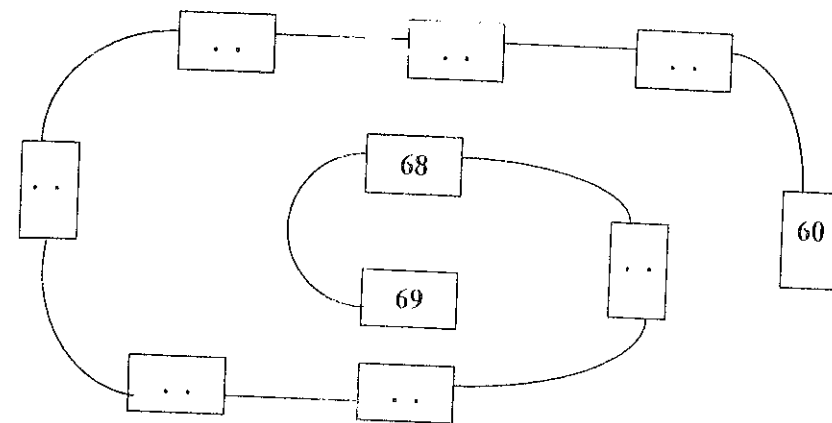

9. Woo tee, ma hinna foo kul hantum zuwoo ra nga dogoo ra.

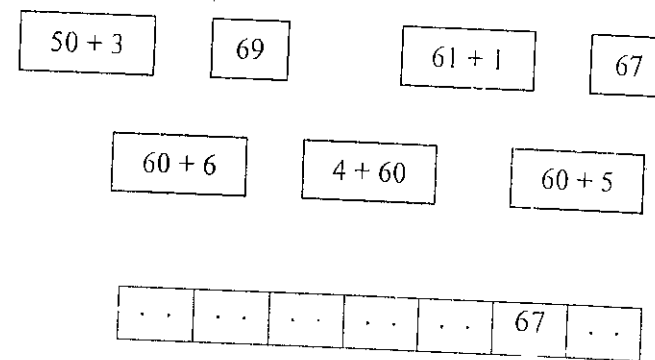

10. Woo tee m'a timmandi.

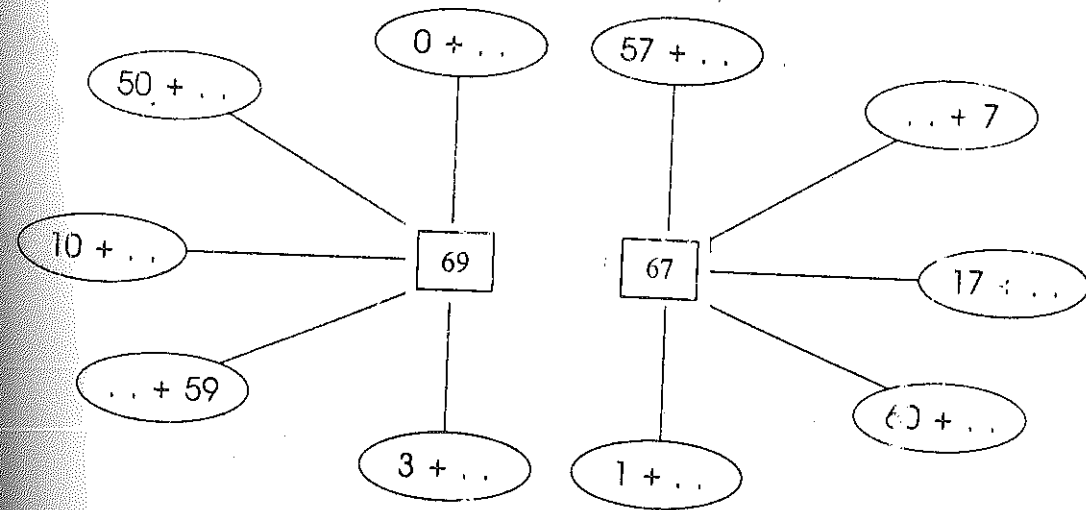

Caw : Kaayan bila lanbari wala nda lanbari
60 ka koy 69 hinnawey

Taasiha : Taalboo ma hin :

- ka kaayan tee kañ goo nda lanbari wala kañ sii nda lanbari ;
- ka kaayan miseyañ tee.

Kabu cahante :

- Kabu nda ihinka-hinka 0 ka koy 60 hinnawey.
- Kabu nda ihinza-hinza 0 ka koy 69 hinnawey.

$$45 + 5 = \quad 35 + 5 =$$

$$15 + 5 = \quad 55 + 5 =$$

Goyjinawey : goyjinawey kañ ga duwandi.

Goyey

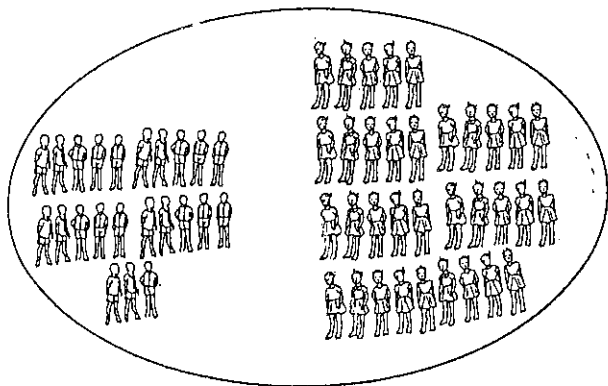

1. **Bonhaw** : Cawhugoo ra, taalibi 57 bara no. 23 kul ti aru.
Marje ti woyey ?
Woyey hinnaa ir ga hin ka duu a nda fondo hinka.

- Kaayan : 57 ti woyey nda arey kul
23 ti arey hinnaa.

Nda ir na arey hinnaa kaa taalibey hinnaa ra kul woyey

hinnaa ma cindi iwoyey | affowey

$$57 - 23 = 34$$

| | |
|-----|---|
| 5 | 7 |
| - 2 | 3 |
| = | |

- **Tontonyan**

Taalibey hinnaa ti 57

Arey hinnaa ti 23

Woyey hinnaa no ma tonton arey hinnaa ga ka tee taalibey hinnaa.

$$23 + \dots = 57$$

| | |
|-----|---|
| 2 | 3 |
| + . | . |
| = 5 | 7 |

Denden : Kaayaney tee.

| | |
|------|------|
| 69 | 60 |
| - 38 | - 20 |
| = | = |

2. **Bonhaw** : Saalihi goo nda basan meetar 64. A na meetar 38 neere. Meetar marje ka cindi ?

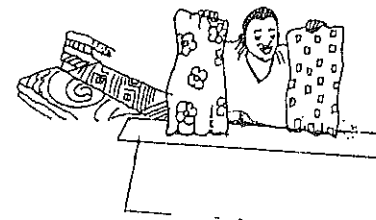

Meetar 64 ra meetar 38 ga hun waati din ir ma duu cindoo.

| | |
|--------|---------|
| iwoyey | affowey |
| 6 | 4 |
| - 3 | 8 |
| = 2 | 2 |

Denden : Kabey tee.

| | |
|------|------|
| 63 | 61 |
| - 49 | - 56 |
| = | = |

Denden

1. Kaayaney tee.

| | | | | | |
|------|------|-----|------|------|-----|
| 69 | 67 | 55 | 62 | 64 | 60 |
| - 35 | - 13 | - 5 | - 46 | - 59 | - 9 |
| = | = | = | = | = | = |

2. Kabey wey timmandi, ma zaabey dam.

| | | | | | |
|------|------|------|------|------|------|
| 65 | 55 | 61 | 64 | .. | .. |
| - .. | - .. | - .. | - .. | - 26 | - 35 |
| = | = | = | = | = | = |

3. Pinaasoo na boro 63 ka tun Yuwar ka koy Diirey. Boro 22 zunbu Tonka. Boro marje ka too Diirey ?
4. Aminta goo nda jiiri 62. Kaynoo goo nda jiiri 40. Jiiri marje nda Aminta zen kaynoo ?
5. Mahamar duu albasar 63 kan 37 kul funbu. Albasar marje ma boori ?

6. Kilomeetar 65 bara Gaawo nda Taaboy game. Hammakulaaji goo kilomeetar 45 Gaawo se. Kilomeetar marje bara Hammakulaaji nda Taaboy game ?

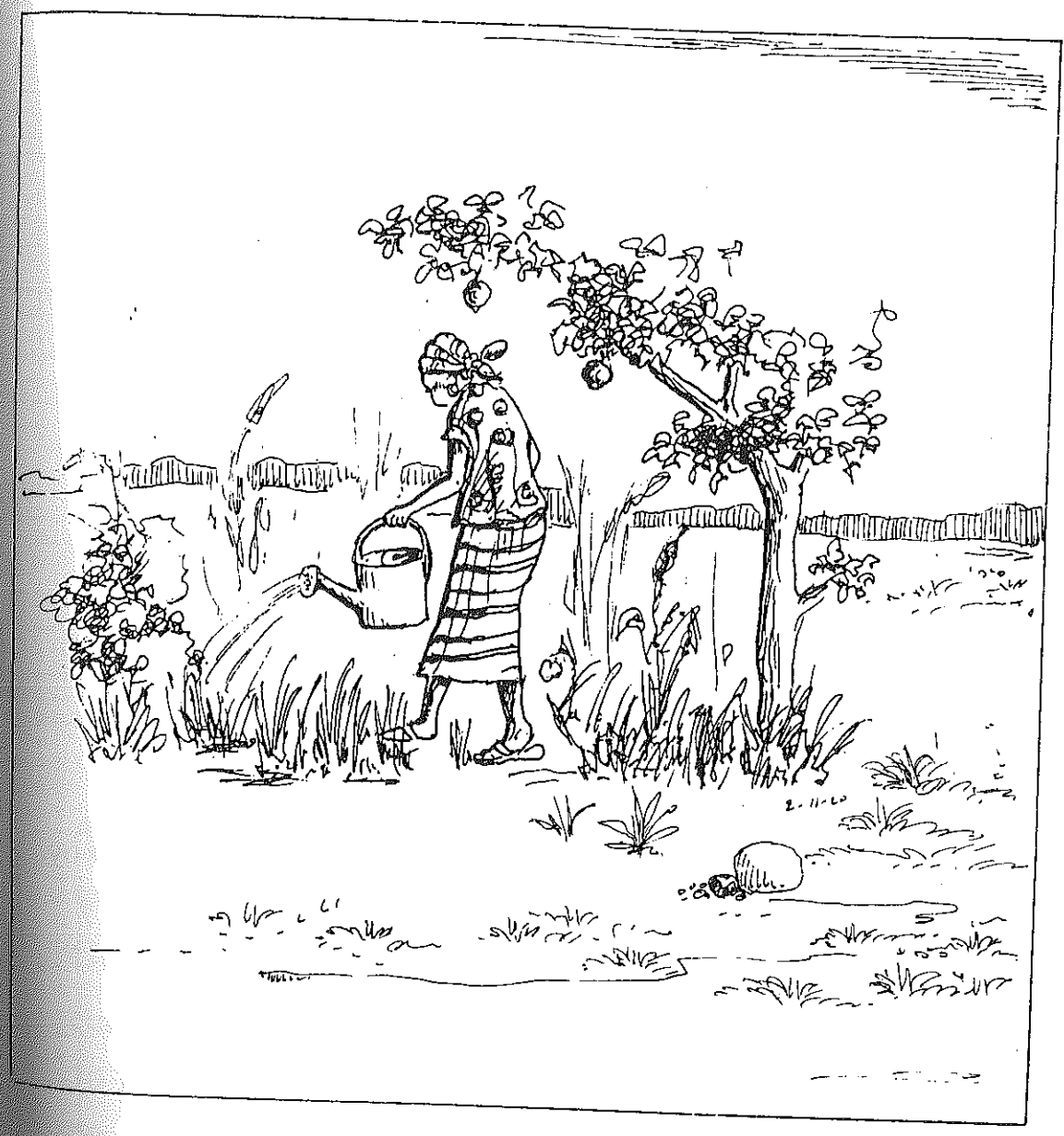

Caw : 70 hinnaa

Taasiha : Taaliboo ma hin :

- ka margari-izey hinnaa kan goo margari ra bay ;
- ka margari cin kan margari-izey si bisa 70 ;
- ka 70 caw, k'a hantum nda kabu-ize nda harfu ;
- ka 70 cin, k'a fesu-fesu.

Kabu cahante :

Ka'ra nda ihinka-hinka : 68 ka yee 50.

Kabu nda igguu-guu : 65 ka yee 45.

$$\begin{array}{r} 60 - 10 = \\ 40 - 10 = \end{array} \qquad \begin{array}{r} 20 - 10 = \\ 10 - 10 = \end{array}$$

Goyjinawey : bundu-ize, tondi.

Goyey

Goy jinaa : Bundu-ize 69 kabu. I kanandi nd'iwoy-woy.

Iwoy boŋ marje bara a ra ? Bundu-ize marje ka cindi ?

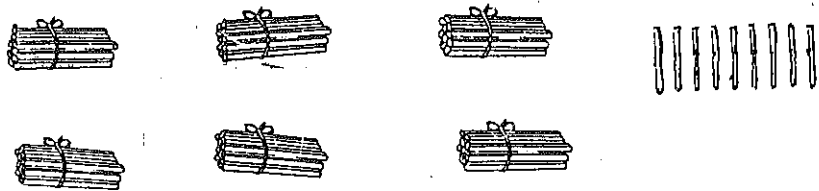

Goy hinkantoo : Bundu-ize foo tonton bundu-ize 69 ga.

I kabu.

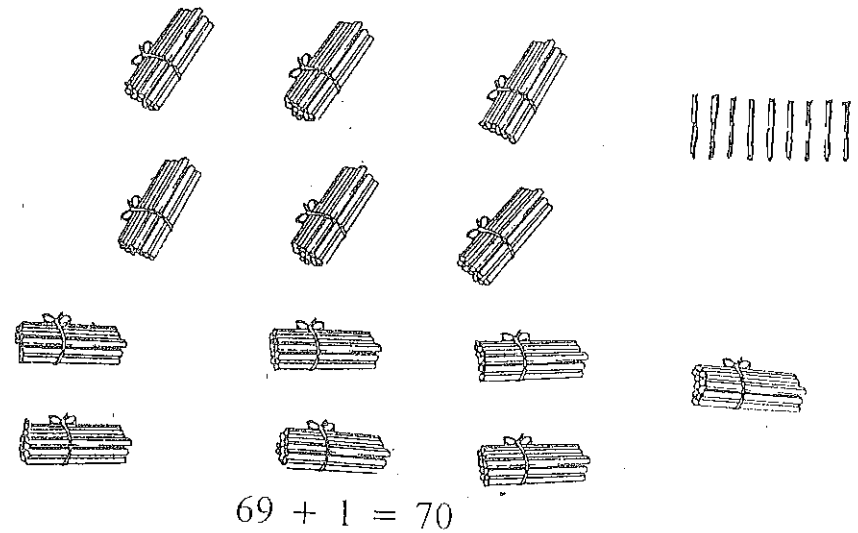

Hinna taagaa hantum daaroo ra. ?

| Iwoyey | Affowey |
|--------|---------|
| 7 | 0 |

Alfagaa ga 70 hantum nda kabu-ize, a g'a har, taalibey g'a har. A ga yee ka 70 hantum a m'a har.

Goy hinzantoo : Alfagaa ga taalibey fahamandi nda 70 cinaroo nda nga fesu-fesuroo.

$$70 = 50 + 20$$

$$70 = 40 + \dots$$

$$70 = 30 + 30 + 10$$

$$70 = 30 + 20 + \dots$$

$$50 + 10 + 10 = 70$$

$$40 + 20 + \dots = 70$$

$$35 + 25 + \dots = 70$$

Denden

1. Tuuru

- Tamaati 70 = kabu-ize 70 wala iwoy boŋ 7
- Boro 70 = kabu-ize - - - wala iwoy boŋ - -
- Tiira 70 = iwoy boŋ - - -
- Feeji 70 = kabu-ize - - -

2. Kabu nda :

- igguu-guu : 0 ka koy 70
- iwoy-woy : 0 ka koy 70
- igguu-guu : 70 ka yee 0
- iwoy-woy : 70 ka yee 0

3. Daaroo woo tee m'a timmandi.

| | | |
|-----|-------------------|---------|
| .. | ----- | 60 + 10 |
| 43 | ----- | --- |
| --- | ----- | 50 + 8 |
| --- | Woydu cindi yagga | --- |
| 26 | ----- | --- |
| - | woyye | --- |

4. Daaroo tee m'a timmandi.

| | | | | |
|----|----|----|----|----|
| + | 10 | 40 | 30 | 20 |
| 10 | | | | |
| 20 | | | | |
| 30 | | | | |

5. Hinnawey kaŋ ga sawa dobu nda zeeri.

| | | |
|---------------------|----|---------|
| Woydu cindi guu | 70 | 60 + 8 |
| Woydu cindi yaaha | 68 | 50 + 15 |
| Woyye | 35 | 60 + 10 |
| Woydu cindi yagga | 69 | 20 + 15 |
| Waranza cindi taaci | 65 | 60 + 9 |

6. Woo tee m'a timmandi.

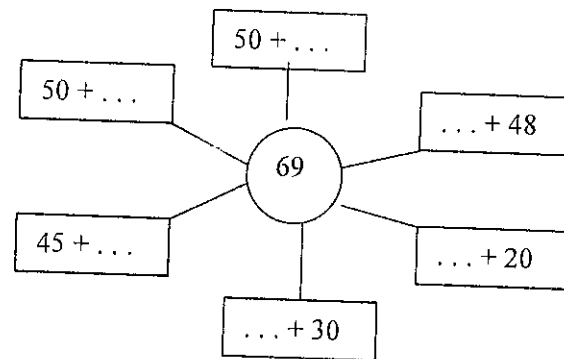

7. Tontonyaney tee.

| | | | | |
|------|------|------|------|------|
| 36 | 38 | 17 | 37 | 12 |
| + 23 | + 25 | + 39 | + 17 | + 37 |
| = | = | + 16 | + 25 | = |
| | | = | = | |

8. Duu hinnawey kaŋ sii no.

| | | | | |
|------|------|------|------|------|
| 35 | .7 | .9 | .. | .7 |
| + .4 | + 42 | + 2. | + 28 | + .4 |
| = 59 | = 69 | = 70 | = 68 | + 29 |
| | | | | = 60 |

Filla : 0 ka koy 70 hinnawey,

Taasiha : Taaliboo ma hin :

- ka tabatandi ka hun 0 ka koy 70 hinnawey ;
- ka kabuyan nda boɗhawyan tee.

Kabu cahante :

- Kabu nda 2-2 ka hun 10 ka koy 40 nda 40 ka yee 10 ;
 - kabu nda 5-5 ka hun 5 ka koy 65 nda 65 ka yee 5 ;
 - kabu nda 10-10 ka hun 10 ka koy 70 nda 70 ka yee 10.

2. - Kabu :

$$12 + 10 = \dots\dots$$

$$20 + 10 = \dots\dots$$

$$53 + 10 = \dots\dots$$

$$40 + 10 = \dots\dots$$

$$59 + 10 = \dots\dots$$

$$60 + 10 = \dots\dots$$

Goyjinawey : Nooru, tiira, tuusuji, kiryon, bundu-ize...

Goyey

Goy jinaa :

1. Timmandi

$$20 = 10 + \dots\dots$$

$$40 = 30 + \dots\dots$$

$$67 = 17 + \dots\dots$$

$$68 = \dots\dots + 30 + 8$$

$$45 = \dots\dots + 20 + 5$$

2. Hinnawey hantum nda harfu

53 ; 66 ; 55 ; 70

3. Hinnawey hantum nda kabu-ize

Yaada, iwoy ; woytaaci, woydu cindi guu ; woyye.

4. Tammaasawey (<wala>) dam nongey ra kaɗ ra i ga hima ka huru.

33 70 ; 65 40

69 70 ; 45 23

35 68 ; 28 70

5. Hinnawey hangandi cere ka hun ibeeroo ka koy ikaccaa ga ; igguu ; iwoy cindi iyeye ; woydu cindi yaaha ; woyye ; woyguu cindi yagga.

Boɗhawey :

1. Haday goo nda furme 35 ; armaa mo furme 22.

Marje ti furmewey kul ?

2. Mamadi na hamiisa 25 dii subbahi, a yee ka hamiisa 45 dii alaasar. Hamiisa marje no a duu ?

3. Feeji 66 goo Ali kaloo ra, wirci huru i ra kaɗ na feeji 14 wii. Feeji marje ka cindi ?

4. Cete foo kuuyanoo ga sawa nda m 52, haroo na m 28 kaɗandi. Meetar marje no ka cindi ?

Filla : 0 ka koy 70 hinnawey,

Taasiha : Taaliboo ma hin :

- ka tabatandi ka hun 0 ka koy 70 hinnawey ;
- ka kabuyan nda bonhawyan tee.

Kabu cahante :

1. - Kabu nda 2-2 ka hun 10 ka koy 40 nda 40 ka yee 10 ;
 - kabu nda 5-5 ka hun 5 ka koy 65 nda 65 ka yee 5 ;
 - kabu nda 10-10 ka hun 10 ka koy 70 nda 70 ka yee 10.
2. - Kabu :

$$12 + 10 = \dots\dots$$

$$20 + 10 = \dots\dots$$

$$53 + 10 = \dots\dots$$

$$40 + 10 = \dots\dots$$

$$59 + 10 = \dots\dots$$

$$60 + 10 = \dots\dots$$

Goyjinawey : Nooru, tiira, tuusuji, kiryon, bundu-ize...

Goyey

Goy jinaa :

1. Timmandi

$$20 = 10 + \dots\dots$$

$$40 = 30 + \dots\dots$$

$$67 = 17 + \dots\dots$$

$$68 = \dots\dots + 30 + 8$$

$$45 = \dots\dots + 20 + 5$$

2. Hinnawey hantum nda harfu

53 ; 66 ; 55 ; 70

3. Hinnawey hantum nda kabu-ize

Yaada, iwoy ; woytaaci, woydu cindi guu ; woyye.

4. Tammaasawey (<wala>) dam nongey ra kan ra i ga hima ka huru.

33 70 ; 65 40

69 70 ; 45 23

35 68 ; 28 70

5. Hinnawey hangandi cere ka hun ibeeroo ka koy ikaccaa ga ; igguu ; iwoy cindi iyeye ; woydu cindi yaaha ; woyye ; woyguu cindi yagga.

Bonhawey :

1. Haday goo nda furme 35 ; armaa mo furme 22.

Marje ti furnewey kul ?

2. Mamadi na hamiisa 25 dii subbahi, a yee ka hamiisa 45 dii alaasar. Hamiisa marje no a duu ?

3. Feeji 66 goo Ali kaloo ra, wirci huru i ra kan na feeji 14 wii. Feeji marje ka cindi ?

4. Cete foo kuuyanoo ga sawa nda m 52, haroo na m 28 kanandi. Meetar marje no ka cindi ?

Caw : Tontonyan nda kaayan mise folloku ra : 70

Taasiha : Taaliboo ma hin :

- ka mise bay kaŋ ra tontonyan nda kaayan goo ;
- ka boŋhaw tee kaŋ ra tontonyan nda kaayan goo.

Kabu cahante :

- Kabu nda igguu-guu 0 ka koy 70.
- Kabu nda iwoy-woy 0 ka koy 70.

Goyjinawey : Nooru, tiira, tuusuji, kiryoŋ, bundu-ize...

Goyey

Goy jinaa : Alfagaa ga yoobu tee cawhugoo ra.

- Ali goo nda kaatibi 14. A ga kiryoŋ nda tuusuji day.

N.B. : Alfagaa ga jinawey miŋey* bayrandi neerekaa se. A ga taalibey zemni kuray-kuray.

Goy hinkantoo : Alfagaa ga nee taalibey ma hayaa kaŋ i dii a senni hantumantaa tee.

Goy hinzantoo : Kuray foo kul ma nga bora sanba a ma senni hantumantaa hantum walhabeeroo ga.

Denden

1. Dooru 70 bara bata foo ra. Handu jinaa, alfagaa goy nda dooru 18. Handu hinkantoo a na dooru 23 ka hantum. Dooru marje ka cindi bataa ra ?

* miŋey : hay = prix

2. Sorko hinza na hamiisa 69 dii. Sinaali na hamiisa 15 dii. Adama hamiisa 27. Hamiisa marje no Koniba n'i dii ?
3. Bitiji ra kayye foo hayoo ti kaatibi 35, windiji, kaatibi 25 ; marje no ma Ali kuma kaŋ goo nda kaatibi 50 hala a ma jinawey wey day ?
4. Fulan foo goo nda haw 25. A na kawsi 4 neere, 7 buu a se. Haw marje bara a se sohō ?
5. Zaari foo ga sawa nda guuru 24. Albanna foo ga guuru 5 goy subbaahi, a ga guuru 4 goy alaasar. Guuru marje no a si i goy zaaroo ra ?
6. Sumaana feeji kuroo ga too feeji 68. A na 23 neere. Feeji marje ka cindi a se ? A na gurmu* 12 day. Feeji marje bara a se ?
7. Naarukaw 60 goo mootateesaa* ga. Loore hinka kay kaŋ ijinaa na boro 35 zaa, ihinkantoo na boro 20 zaa. Naarukaw marje ka cindi ?
8. Kaar hinza ga hima ka boro 69 sanbu. Ijinaa na boro 27 zaa, ihinkantoo, boro 29. Boro marje no ma hima ka huru ihinzantoo ra ?

* gurmu = gunburu.

* mootateesa : mobil gaar = mobil fandidoo.

Caw : 70 ka koy 79 hinnawey

Taasiha : Taaliboo ma hin :

- ka margari-izey hinnaa kaŋ goo margari ra bay ;
- ka ka hun 70 ka koy 79 hinnawey caw, k'i hantum kabu-ize nda harfu ra ;
- ka jinayyaŋ kanandi nda iwoy-woy, a ma iwoy boŋey nda affowey fay, a m'i hantum ;
- ka hinna bayray goyjinawey ka hinna tana cebe ;
- ka kabu-ize foo alkadaroo bay hinna ra ;
- ka 70 ka koy 79 hinnawey fesu-fesu wala k'i cin, sanda ka iwoy boŋey nda affowey bayrandi ;
- ka jinay margari tee kaŋ margari-izey hinnaa ga bayrandi ;
- ka 0 ka koy 79 hinnawey hanga-hangandi cere bande, ka kabu 1 ka koy 79 hinnawey ga.

Kabu cahante :

- kabu nda igguu-guu hala 65.
- kabu nda iwoy-woy hala 70.

Goyjinawey : bundu-ize, tondi, hinnabayray goyjinawey nda goyjinawey kaŋ ga duwandi.

Goyey

Goy jinaa : Alfagaa ma nee taalibi foo kul ma :

- bundu-ize 10 hawari 6 nda bundu-ize 9 jisi nga jine taabaloo boŋ ;
- bundu-ize 1 tonton bundu-ize 9 ga, a ma bundu-ize woyaa

(10) barmay nda iwoy hawari 1 ;

- bundu-ize 10 hawari hinnaa kaŋ a duu a hantum : 7
- Alfagaa ma hantum walhabeeroo ga : 70 ; a m'a har, a m'a hantum nda harfu : woyye.

Goy hinkantoo : Alfagaa ma 71 hantum, a m'a har ; taalibey m'a har a bande.

- Alfagaa ma nee taalibey ma bundu-ize 10 hawari nda bundu-ize hinnaa cebe kaŋ ga sawa nda 71. Maanaa bundu-ize hawari 7 nda bundu-ize 1.

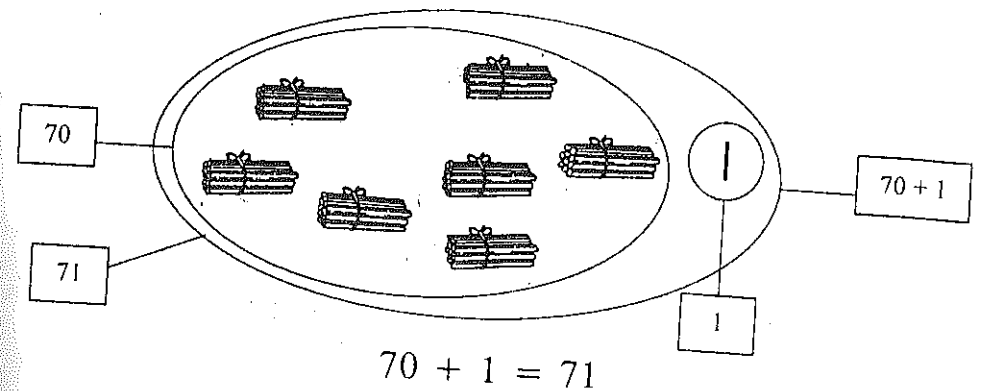

- Alfagaa nda taalibey ma yee goy follokaa ga nda hinnawey wey : 72, 73, 74, 75, 76, 77, 78, 79.

Goy hinzantoo :

a. Daaroo woo tee m'a timmandi.

| | |
|---|---|
| i | a |
| . | . |

b. Daaroo woo tee ma hinnaa hantum ra.

| | |
|---|---|
| i | a |
| . | . |

c. Bundu-ize 10 hawari nda bundu-ize hinnaa biyey tee ka duu hinnaa kan goo hugu-izoo ra : 74 ; 63 ; 77.

d. Daaroo tee m'a timmandi

| | | | |
|----|----------------------------|------|-------------------|
| .. | Iwoy boŋ .. nda affowey .. | 70+5 | ... |
| .. | Iwoy boŋ .. nda affowey .. | .. | Woyye cindi hinza |
| 66 | Iwoy boŋ .. nda affowey .. | .. | |
| .. | Iwoy boŋ 7 nda affowey 6 | .. | .. |
| .. | Iwoy boŋ .. nda affowey .. | 60+9 | .. |

Goy taacantoo : hinnawey 0 ka koy 79 deedandi.

Deedandoo ga hin ka tee nda taka hinka.

- Ijinaa : 70 ga jin 75 se, saa din 70 kacca nda 75, boro ga hantum $70 < 75$ wala $75 > 70$.
- Ithinkantoo : kabu-ize foo alkadaroo, hinna ra : hinnawey kan iwoy boŋey ga fay, sanda ka 63 nda 70 deedandi.

Hinna beeroo ti woo kan goo nda iwoy boŋ beeroo, maanaa $70 > 63$ wala $63 < 70$.

Denden

1. Woo hantum, m'a timmandi.

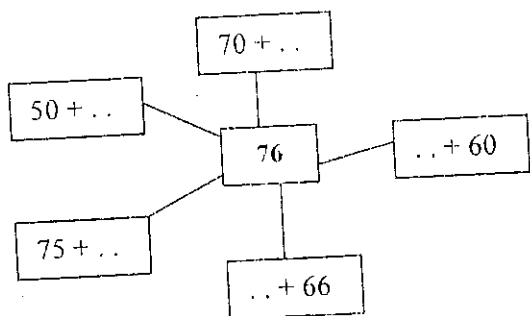

2. Tammaasawey wey dam dogey ra : >, < wala =.

| | | |
|----------|---------------|---------------|
| 69 .. 70 | 38 .. 48 | 73 .. 77 |
| 51 .. 54 | 74 .. 70 + 6 | 64 + 10 .. 67 |
| 42 .. 66 | 30 + 40 .. 70 | 61 .. 71 |
| 67 .. 4 | 63 .. 50 + 3 | 71 .. 60 + 11 |

3. Daaroo tee m'a timmandi.

| | | | |
|----|----------------------------|-----------------|--------|
| .. | Iwoy boŋ .. nda affowey .. | .. | 70 + 7 |
| .. | Iwoy boŋ .. nda affowey .. | Woyye cindi foo | .. |
| 63 | Iwoy boŋ .. nda affowey .. | .. | .. |
| .. | Iwoy boŋ 6 nda affowey 7 | | |
| .. | Iwoy boŋ .. nda affowey .. | .. | 70 + 9 |

4. Wey hantum ma hinna foo kul dobu nga fesu-fesyaneey ga nda zeeri

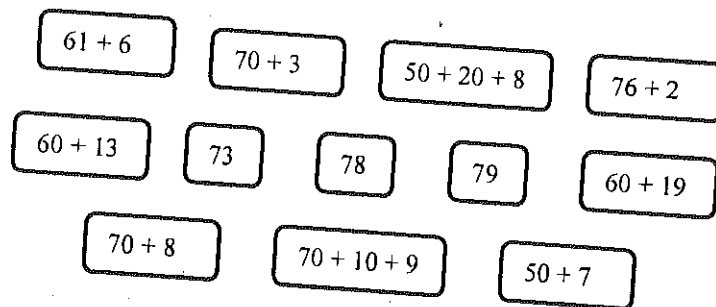

3. Hinnawey wey deedandi nda tammaasawey affoo :

>, <wala =

$$30 + 5 + 20 \dots\dots 30 + 20$$

$$25 + 22 + 12 \dots\dots 2 + 20 + 50$$

$$12 + 28 + 25 \dots\dots 25 + 12 + 28$$

4. Sorko wey foo na hamiisa 46 neere subbaahoo ra. A na hamiisa 35 neere alaasaroo ra. Hamiisa marje no a n'a neere zaaroo ra ?

5. Sahalu na sun 17 fanji Adama pinaasoo ra. Dunday na sun 25 tonton i ga. Nd'a gar pinaasoo ga hin ka sun 61 zaa sun marje no Buuba ga hin k'i fanji pinaasoo ra ?

6. Kaatibi 70 goo Adiiza kone. A na kayye foo day kaatibi 45 nda kalam foo k.15. Kaatibi marje ka cindi Adiiza se ?

7. Sorko foo na barra 75 dii nga sankawey ra. Izewoy beeroo na barra 38 neere, ikaccaa na 27 neere. Barra marje ka cindi ?

8. Kaaji taalibey na guusu 73 fansi tuuri dumayan se. I na miliya 25 nda makkabaani 39 дума. Guusu marje ka cindi kaŋ ra tuuri mana дума ?

9. Mamadu na leemur 52 kosu. Siidi na leemur 25 kosu. Leemur marje no ngi boro hinkaa n'i kosu ?

Caw : 80 hinnaa

Taasiha : Taaliboo ma hin :

- ka margari cin kaŋ ga sawa nda 80 ;
- ka 80 caw, k'a hantum nda kabu-ize nda harfu ;
- ka 80 cin wala k'a fesu-fesu ;
- ka 0 ka koy 80 hinnawey hanga-hangandi cere ;
- ka kabu affoo ka koy 80.

Kabu cahante :

- Kabu nda iwoy-woy ka hun 0 ka koy 70 ;
- kabu nda igguu-guu ka hun 0 ka koy 75.

Goyjinawey : bundu-ize, tondi.

Goyey

Goy jinaa : Taalibi foo kul ma bundu-ize iwoy boŋ 7 nda bundu-ize 9 kabu.

- A ma bundu-ize foo tonton 9 ga.



$$9 + 1 = 10 = \text{iwoy boŋ foo.}$$

Nda iwoy boŋ foo tonton iwoy boŋ iyye ga, ga sawa nda.

$$70 + 10 = 80$$

- Iwoy boŋ marje no ni ga duu, m'a hantum daaroo ra.

| Iwoyey | Affowey |
|--------|---------|
| | |

Bundu-ize 80 = iwoy boŋ 8 nda affowey 0.
 Tiira 80 = iwoy boŋ 8 nda affowey 0.
 Haw 80 = iwoy boŋ marje no ?

Goy hinkantoo : Hanga-hangandi cere : 0 ka koy 80
 hinnawey sanda 0-10-20-30-40-50-60-70-80
 - Kabu 0 ka koy 80 hinnawey nda 80 ka yee 0

Denden

- Kabu nda 10-10 : 0 ka koy 80 hinnawey
 Kabu nda 5-5 : 0 ka koy 80 hinnawey
 Kabu nda 20-20 ka koy 80 hinnaa
- Kabu nda 10 : 80 ka yee 0
 40 : 80 ka yee 0

Denden

$$\begin{array}{r}
 37 \\
 +42 \\
 \hline
 =
 \end{array}
 \quad
 \begin{array}{r}
 35 \\
 +13 \\
 \hline
 =
 \end{array}
 \quad
 \begin{array}{r}
 26 \\
 +18 \\
 \hline
 =
 \end{array}
 \quad
 \begin{array}{r}
 56 \\
 +24 \\
 \hline
 =
 \end{array}
 \quad
 \begin{array}{r}
 47 \\
 +29 \\
 \hline
 =
 \end{array}
 \quad
 \begin{array}{r}
 38 \\
 +42 \\
 \hline
 =
 \end{array}$$

3. Daaroo woo tee m'a timmandi.

| | | | |
|----|----------------------------|------|-------------------|
| 55 | Iwoy boŋ .. nda affowey .. | 50+5 | ----- |
| .. | Iwoy boŋ .. nda affowey .. | | Woydu cindi hinza |
| .. | Iwoy boŋ 7 nda affowey 9 | | ----- |
| 73 | Iwoy boŋ .. nda affowey .. | | ----- |
| .. | Iwoy boŋ nda affowey | 70+0 | ----- |
| 77 | Iwoy boŋ .. nda affowey .. | | ----- |

4. Tammaasawey wey <, > wala = dam.

- 35 ----- 45
 59 ----- 69
 57 ----- 50 + 7
 50 ----- 49 + 1
 47 ----- 74
 70 ----- 80
 65 ----- 80

5. Aminta duu mangoro 54, naŋoo n'a noo mangoro 24. Mangoro marje no Aminta duu ?

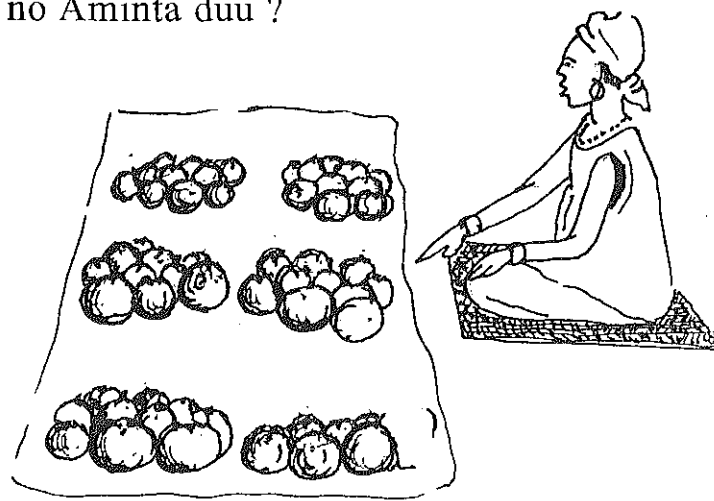

Caw : Tontonyan nda kaayan:80 hinnaa

aaasiha : Taaliboo ma hin :

- ka kaayan wala tontonyan mise bay ;
- ka kaayan wala tontonyan tee ;
- ka mise kaɗ ra tontonyan wala kaayan goo boɗfeeraa tee.

Goyjinawey : Goyjinawey kaɗ ga duwandi..

Goyey

Boɗhaw : Benke kaaroo tun Gaawoo nda boro 80. Boro 22 zunbu Mowti, 35 zunbu Segu. Boro marje ka cindi kaaroo ra kaɗ a ga too Bamako ?

Laasaabu : Boro marje nda kaaroo tun Gaawoo ?

Boro marje ka zunbu fondaara ?

Marje ti naarukey hinnaa kaɗ zunbu teesa* kokorantaa ra ?

Kabu dumi foo no boro g'a tee ka duu borey hinnaa kaɗ zunbu fondaara ?

Kabu dumi foo no boro g'a tee ka duu naarukey hinnaa kaɗ too Bamako ?

Kabu dumey daaru, m'i tee.

Borey kaɗ zunbu fondaara ra hinnaa ti :

$$22 + 35 = 57$$

* teesa : moototeesa = gaar = fandidoo

Naarukey kaɗ too Bamako hinnaa ti :

$$80 - 57 = ?$$

Denden

1. Tontoney tee.

| | | | | | |
|-----|-----|-----|-----|-----|-----|
| 36 | 44 | 65 | 53 | 32 | 38 |
| +27 | +36 | +14 | +27 | +47 | +42 |
| = | = | = | = | = | = |

2. Kaayaney tee.

| | | | | | |
|-----|-----|-----|-----|----|-----|
| 75 | 80 | 69 | 80 | 80 | 68 |
| -38 | -49 | -15 | -20 | -8 | -42 |
| = | = | = | = | = | = |

3. Timmandi.

| | | | |
|------|------|------|------|
| 43 | 16 | 77 | .. |
| + .. | + 6. | - .. | - 49 |
| = 79 | = 80 | = 58 | = 31 |

4. Hinnawey wey deedandi nda tammaasawey wey affoo :

>, < wala =

$$40 + 6 + 10 - - - - 30 + 25$$

$$23 + 19 + 13 - - - 3 + 17 + 40$$

$$24 + 10 + 15 - - - 10 + 24 + 15$$

5. Hamma na kaatibi 20 fita nda kaatibi 45 sukar zaa. A na neerekaa noo kaatibi 80. Marje no neerekaa g'a yeeti a se ?

foo ga tee jirbi hinza ra. Zurandikaw 79
 jinaa boro 24 fura, zaari hinkantoo, boro
 o ka zuraa benandi ?
 a, gorodoo 30 bara beene, 45 goo ganda,
 goro. Gorodoo marje ka cindi ?
 i 35 kaa sardiŋaa ra. Woyme beeroo n'a
 Tamaati marje bara Fattu kokondaa ra ?
 73 tee. A na 65 neere. Furme marje ka

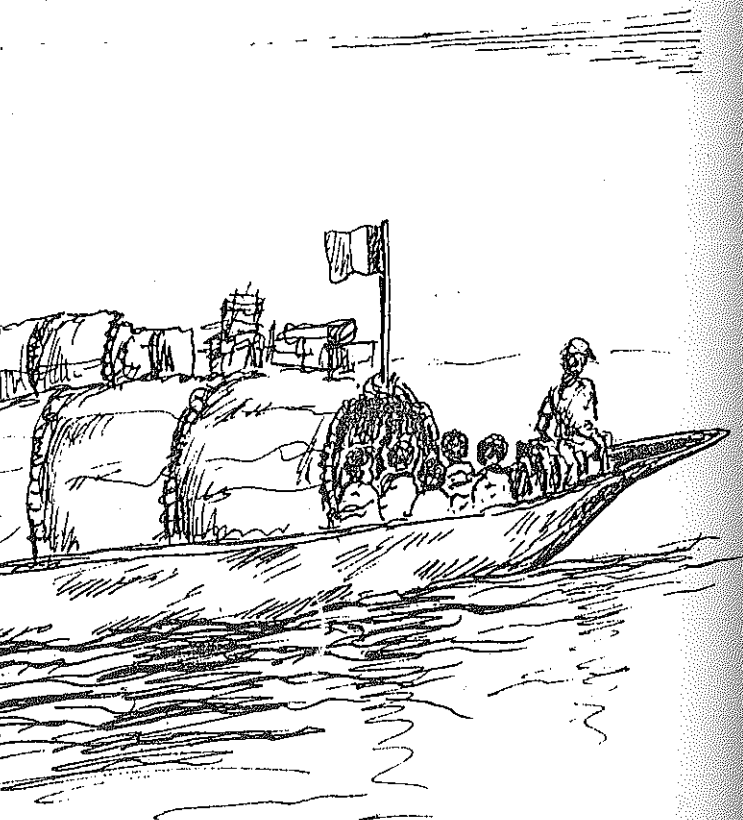

Caw : 80 ka koy 89 hinnawey

Taasiha : Taaliboo ma hin:

- ka margari-izey hinnaa kaŋ goo margari ra bay ;
- ka hun 80 ka koy 89 hinnawey caw, k'i hantum kabu-ize nda harfu ra ;
- ka jinayyaŋ kanandi nda iwoy-woy, a ma iwoyboŋey nda affowey fay, a m'i hantum ;
- ka hinnabayray goyjinawey ka hinna tana cebe ;
- ka kabu-ize foo alkadaroo bay hinna ra ;
- ka hun 80 ka koy 89 hinnawey fesu-fesu wala k'i cin sanda ka iwoy boŋey nda affowey bayrandi ;
- ka jinay margari tee kaŋ margari-izey hinnaa ga bayrandi ;
- ka 0 ka koy 89 hinnawey hanga-hangandi cere bande.

Kabu cahante

- Kabu nda itaaci-taaci hala 80 ;
- kabu nda yaaha-yaaha hala 80 ;
- kabu nda waranka-waranka hala 80.

Goyjinawey : bundu-ize, tondi, hinna bayray goyjinawey nda goyjinawey kaŋ ga duwandi.

Goyey

Goy jinaa : Alfagaa ma nee taalibi foo kul ma :

- bundu-ize 10 hawari 7 nda bundu-ize 9 jisi nga jine taabaloo bon :

- bundu-ize 10 hawari hinnaa kaɗ a duu a hantum : 8.

Goy hinkantoo : Alfagaa ma 81 hantum, a m'a har, taalibey m'a har a bande.

- Alfagaa ma nee taalibey ma bundu-ize 10 hawari nda bundu-ize hinnaa cebe kaɗ ga sawa nda 81. Maanaa bundu-ize hawari 8 nda bundu-ize 1.

- Alfagaa nda taalibey ma yee goy follokaa ga nda hinnawey wey : 82 ka koy 89 hinnawey. $80 + 1 = 81$

Goy hinzantoo :

a. Daaroo tee m'a timmandi.

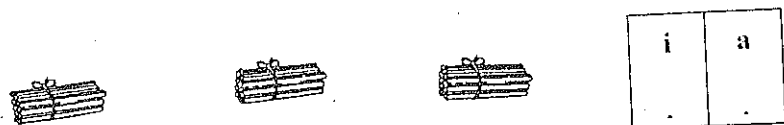

b. Biyoo tee ma hinnaa hantum daaroo ra



c. Bundu-ize 10 hawari nda bundu-ize hinnaa biyey tee ka duu hinnaa kaɗ goo hugu-izoo ra : 85 ; 78 ; 82.

d. Daaroo tee m'a timmandi :

| | | | |
|----|----------------------------|--------|----------------------|
| .. | Iwoy boɗ .. nda affowey .. | 80 + 6 | .. |
| .. | Iwoy boɗ .. nda affowey .. | .. | Woyyaaha cindi taaci |
| 80 | Iwoy boɗ .. nda affowey .. | .. | .. |
| .. | Iwoy boɗ 6 nda affowey 7 | .. | .. |
| .. | Iwoy boɗ .. nda affowey .. | 70 + 8 | .. |

Goy taacantoo : hinnawey 0 ka koy 89 deedandi. Deedandoo ga hin ka tee nda taka hinka.

Ijinaa : 70 ga jin 83 se, saa din 70 kacca nda 83, boro ga hantum $70 < 83$ wala $83 > 70$.

Ihinkantoo : kabu-ize foo alkadaroo hinnaa ra : hinnawey kaɗ iwoy boɗey ga fay, sanda ka 84 nda 87 deedandi.

Hinna beeroo ti woo kaɗ goo nda iwoy boɗ beeroo, maanaa $87 > 84$ wala $84 < 87$.

Denden

1. Daroo tee, m'a timmandi

| | |
|----|------------------|
| 76 | |
| 67 | Woydu cindi iyye |
| 80 | |
| 89 | |

2. Tammaasawey wey dam dogey ra : $>$, $<$ wala =

- | | | |
|----------|---------------|---------------|
| 79 .. 81 | 39 .. 50 | 84 .. 78 |
| 61 .. 58 | 75 .. 50 + 7 | 54 + 10 .. 66 |
| 18 .. 81 | 40 + 40 .. 70 | 71 .. 81 |
| 77 .. 11 | 63 .. 50 + 13 | 71 .. 60 + 11 |

3. Hinnawey kaŋ kacca nda 75 berandi m'i koli

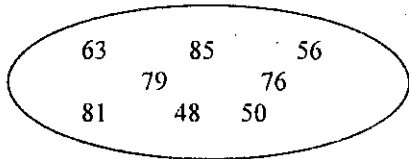

4. Hinnawey kaŋ beeri nda 80 berandi m'i koli

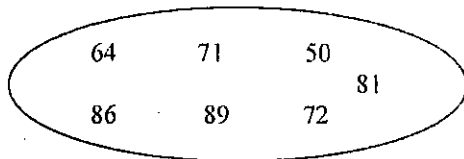

5. Daaroo tee m'a timmandi :

| | | | |
|----|----------------------|----------------------------|--------|
| 76 | .. | Iwoy boŋ .. nda affowey .. | 70 + 6 |
| .. | Woyyaaha cindi hinka | Iwoy boŋ .. nda affowey .. | 80 + 2 |
| 57 | .. | Iwoy boŋ .. nda affowey .. | .. |
| .. | .. | Iwoy boŋ 3 nda affowey 5 | .. |
| 86 | .. | Iwoy boŋ .. nda affowey .. | .. |

6. Woo tee ma hinna foo kul dobu nga fesu-fesuyaney ga nda zeeri.

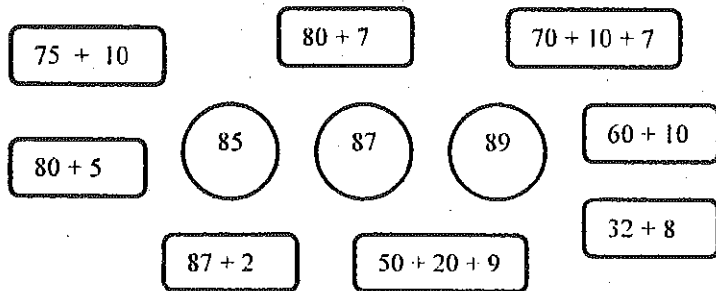

Caw : Tontonyan nda kaayan:80 ka koy 89-hinnawey

Taasiha : Taaliboo ma hin :

- ka kaayan wala tontonyan mise bay ;
- ka kaayan wala tontonyan tee ;
- ka mise kaŋ ra tontonyan wala kaayan goo bonfeeraa tee.

Goyjinawey : Goyjinawey kaŋ ga duwandi.

Goyey



Bonhaw : Salma doo yooboo ra nda galaasi 62. Galaasi 43 day, 17 menne. Galaasi marje ka cindi kaŋ ga hin ka neerandi ?

Laasaabu : Galaasi marje nda Salma tun hugey ?

Galaasi marje ka dayandi ?

Galaasi marje ka hasara Salma se ?

Marje no ma hun galaasey ra ?

Galaasi marje ka cindi kaŋ ga hin ka neerandi ?

- Kabu dumi foo no ma tee ka duu galaasey hinnaa kaŋ hun ?

- Kabu dumi foo no boro g'a tee ka duu galaasi hinnaa kaŋ ga hin ka neerandi ?

- Kabu dumey daaru m'i tee.

Galaasi hinnaa kaḅ hun ti :

$$43 + 17 = 60$$

Galaasi hinnaa kaḅ ga hin ka neerandi ti :

$$62 - 60 = ?$$

Denden

1. Tontonyaney tee.

| | | | | |
|-------|-------|-------|-------|-------|
| 44 | 55 | 56 | 63 | 43 |
| +37 | +28 | +28 | +21 | +37 |
| <hr/> | <hr/> | <hr/> | <hr/> | <hr/> |
| = | = | = | = | = |

2. Kaayaney tee.

| | | | | |
|-------|-------|-------|-------|-------|
| 85 | 82 | 89 | 81 | 86 |
| -36 | -43 | -40 | -9 | -76 |
| <hr/> | <hr/> | <hr/> | <hr/> | <hr/> |
| = | = | = | = | = |

3. Timmandi.

| | | | |
|-------|-------|-------|-------|
| 53 | 47 | 86 | .. |
| + .. | + .. | - .. | -56 |
| <hr/> | <hr/> | <hr/> | <hr/> |
| = 85 | = 89 | = 42 | = 24 |

4. Hinnawey wey deedandi nda tammaasawey wey affoo :

>, < wala =

$$50 + 7 + 20 \text{ --- } 60 + 27$$

$$4 + 18 + 23 \text{ --- } 4 + 18 + 50$$

$$43 + 21 + 7 \text{ --- } 7 + 21 + 43$$

5. Miniti 60 bara guuru foo ra. Sumaana na miniti 23 tee koyraa nda galloo game. Kaḅ a ga yee, a na miniti 25 tee.

Miniti marje k'a kuma a ma guuru foo tee ?

6. Baggoo si hin haya kaḅ bisa ton 70. Loore hinza ma hima ka deḅ. Ijinaa tiḅaa ti ton 30, ihinkantoo tiḅaa ti 27, ihinzantoo, ton 15. Baggoo ga hin ka loorawey kul zaa wala ?
7. Boro 65 no ma hin ka Mohomodu faaroo beeri. Atinnoo hane boro 25 koy goy. Alhamiisa hane goykaw 27 no a duu. Boro marje no a ga hima ka zaa goyoo ma ben alhadoo hane ?
8. Agiisa goo nda alman boḅ 83 kaḅ gaaru 17 nda feeji-ize 45 bara i ra. Marje ti feeji woyey hinnaa ?
9. Kaydiyaa ra milimeetar 82 ncirpi ka kaḅ Jenne. Tunbutu duu ncirpi hinza jiiroo ra : milimeetar 23 nda milimeetar 42 nda milimeetar 5. Milimeetar marje nda Jenne bisa Tunbutu ?
10. Hamiisa hinka tiḅaa cere ra ti kilo 60. Ham-izoo tiḅaa ti kilo 45. Marje ti deesoo tiḅaa ?
11. Meetar 70 guusuyan no Jebok day taagaa ga hima ka duu a. Meetar 35 no fansakaa duu kaḅ a wirci. Meetar marje ka cindi a se ?
12. Manna milimeetar 85 ncirpi n'ir duu. Haray jiiroo ir mana duu kala milimeetar 77. Milimeetar marje nda manna bisa jiiroo ?
13. Feraw 64 ma hima ka karandi. Kuray jinaa ga feraw 23 kar, ihinkantoo 22. Feraw marje no kuray koraa ga kara ?

Caw : 90 hinnaa

Taasiha : Taaliboo ma hin :

- ka margari-izey hinnaa bay ;
- ka margari cin kañ izey ga sawa nda 90 ;
- ka 90 caw k'a hantum nda kabu-ize nda harfu ;
- ka 90 cin wala k'a fesu-fesu.

Goyjinawey : bundu-ize, tondi-ize, garbay guli.

Kabu cahante :

- Kabu nda 10-10 ka hun 0 ka koy 80 ;
- Kabu nda 1-1 ka hun 80 ka koy 89 ;
- Muusa goo nda teenay 83, Isaa n'a noo teenay 5. Marje ti Muusa teenawey hinnaa sohō ?

Goyey

Goy jinaa : Alfagaa ma nee taalibey ma bundu-ize 89 zaa iwoy-woy boñ nda affo-foo. A m'i hāa : iwoy boñ marje nda bundu-ize marje no ? (iwoy boñ 8 nda bundu-ize 9). A ma nee taalibey ma 89 hantum.

Alfagaa ma nee taalibey ma yee ka bundu-ize foo zaa, i m'a tonton 89 margaroo ga. Alfagaa m'i hāa : iwoy boñ marje no war duu sohō ? (iwoy boñ 9 kañ banda ga haya kul mana cindi). Alfagaa ma nee : « Woo ti bundu-ize woy yagga ». Taalibey m'a har-har.

Goy hinkantoo : Alfagaa ma nee taalibey ma ngi walhawey zaa. Nga nd'ey ma goyoo biyoo tee walhawey ga.

Goy hinzantoo : Alfagaa nda taalibey ma margari foo hinnaa hantum a cire. A ma nee taalibey ma 90 hantumoo laasaabu, a m'i hāa : kabu-ize marje ma 90 hantum ? Marje ti iwoy boñey kabu-izoo, nda affowey kabu-izoo ?

Taalibey ma 90 hantum. Alfagaa ma 90 hantum nda harfu, taalibey mo m'a hantum.

Goy taacantoo : Alfagaa ma nee taalibey ma 90 cin cee boobo nda goyjinay tanayañ sanda tondi-izey nda garbay guley.

Denden : Kabey wey timmandi

$$\begin{array}{cccccccc}
 50 & 45 & 48 & 60 & 73 & & 39 & 66 & 75 \\
 + 40 & + \dots & + 42 & + 30 & + \dots & + & 51 & + 24 & + 15 \\
 \hline
 = & = 90 & = & = & = & = & = & = & =
 \end{array}$$

Goy guwantoo : Alfagaa ma willi 90 hantumoo ga nda kabu-izey. A ma nee taalibey ma iwoy boñey hinnaa har, i ma affowey sorraa wanoo har.

Goy idduwantoo : Alfagaa ma nee taalibey m'a fesu-fesu (hinna hinka, nda hinna hinza, nda hinna 9, nda hinna 5...) sanda :
 $90 = 45 + 45$; $90 = 40 + 40 + 10$; $90 = 20 + 20 + 20 + 20 + 10$;
 $90 = 10 + 10 + 10 + 10 + 10 + 10 + 10 + 10 + 10$.

Goy iyyantoo : Alfagaa ma taalibey hāa nda margarey kañ ga huru cere ga ka 90 cin sanda :

$$\begin{array}{l}
 45 + 45 = 90 ; \quad 40 + 50 = 90 ; \quad 30 + 30 + 30 = 90 ; \\
 40 + 30 + 20 = 90 ; \quad 30 + 20 + 10 + 25 + 5 = 90.
 \end{array}$$

Denden

- Hinnawey durse ka hun 80 ka koy 90 nda affoo-foo.
- Hinnawey durse ka hun 90 ka doo 80 nda affoo-foo.
- Hinnawey wey deedandi nda $<$, wala $>$.
86 nda 90 ; 79 nda 90 ; 90 nda 85 ; 90 nda 68.
- Hinnawey wey hanga-hangandi cere bande ka hun i kul ibeeroo ga ka koy i kul ikaccaa ga : 35, 28, 59, 60, 17, 89, 46, 90.
- Hinna follokey hanga-hangandi cere bande ka hun i kul ikaccaa ga ka koy i kul ibeeroo ga.
- 90 fesu-fesu margari 1 nda 5.
- Margari 4 tee kañ ga tonton cere ga ka ti 90.
- 90 fesu-fesey wey timmandi.

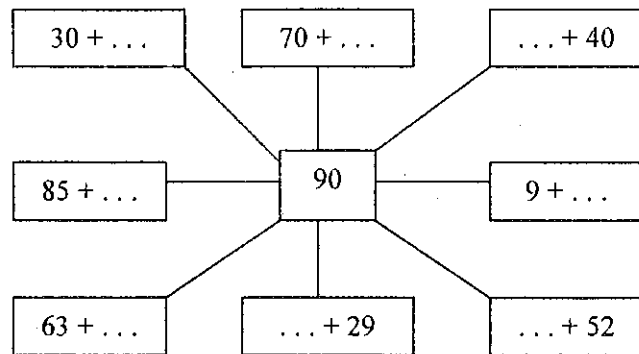

Caw : 90 ka koy 99 hinnawey

Taasiha : Taaliboo ma hin :

- ka margari-izey hinnaa bay margari ra ;
- ka hinnawey cin ka hun 90 ga ka koy 99 ;
- k'i caw, k'i hantum nda kabu-ize nda harfu ;
- ka margari tee kañ ra margari-ize 90 goo, ka iwoy boñey nd'affowey kabu, ka zaaboo hantum ;
- ka kabu-izey dogoo bay hinna ra ;
- ka hinna cin, k'a fesu-fesu : 90 ka koy 99 (iwoy boñey nda affowey) ;
- ka margari tee kañ margari-izey ga bayrandi ;
- ka hinnawey hanga-hangandi cere bande 90 ka koy 99 ;
- ka hinnawey durse 90 ka koy 99.

Goyjinawey : Tondi-ize, bundu-ize, garbay guli.

Kabu cahante :

- Kabu nd'iwoy-woy ka hun 0 ka koy 90 ;
- Kabu nd'affoo-foo ka hun 80 ka koy 90.

Goyey

Goy jinaa : Alfagaa ma nee taalibey ma bundu-ize 90 margari foo kabu nd'iwoy-woy, i ma 90 hantum nda kabu-ize nda harfu.

- Alfagaa ma yee ka nee taalibey ma bundu-ize foo sanbu, i m'a tonton woy yaggaa ga. Taalibey ma laasaabu kañ bundu-ize iwoy boñ 9 nda bundu-ize foo no. Alfagaa ma

nee : « Woo ti bundu-ize woy yagga cindi foo.» Taalibey m'a har-har.

- Alfagaa nda taalibey ma goyoo biyoo tee, i ma margari foo kul hinnaa hantum a cire ?

Alfagaa nda taalibey ma 91 hantum walhawey ga nda kabu-ize nda harfu. Taalibey ma laasaabu kan kabu-ize hinka ma 91 hantum : iwoy boŋ 9 nda affowey 1.

Goy hinkantoo : Alfagaa ma nee taalibey ma bundu-ize 91 margaroo sanbu, i ma yee ka bundu-ize foo zaa, i m'a tonton a ga.

I ma laasaabu kan ngi duu iwoy boŋ 9 nda bundu-ize 2.

Alfagaa ma nee : woo ti bundu-ize 92. Taalibey m'a har-har.

Alfagaa nda taalibey ma goyoo biyoo tee walhawey ga, i ma margari foo kul hinnaa hantum a cire, i ma 92 hantum kabu-ize nda harfu ra.

Goy hinzantoo : Alfagaa nda taalibey ma hinnawey cindey cin hala 99 ga nda taka follokaa.

- I ma goyey filla nda goyjinay tana (tondi-ize, wala garbay guli).

- Taalibey ma hinnawey kabu ka hun 90 ka koy 99 nda ka hun 99 ka kaa 90.

Denden

1. Tondi-izey wey biyey tee, ma ngi hinnaa hantum dengaroo* ra kan goo margaroo jeroo ga.

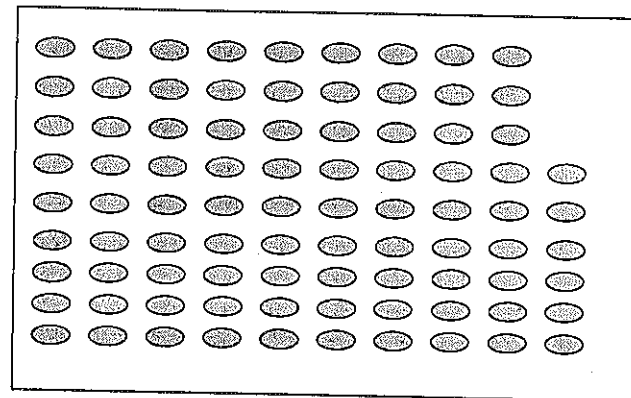

2. Biyey tee m'i timmandi ka duu 98.

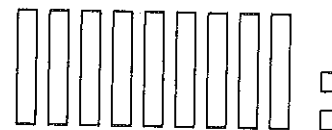

3. Daaroo tee, ma goyoo timmandi.

| | | |
|----|----------------------------------|-----------------|
| 91 | Iwoy boŋ - - - - nda affoo - - - | 90 nda 1 |
| .. | Iwoy boŋ - - - - nda affoo - - - | 90 nda 5 |
| 99 | Iwoy boŋ - - - - nda affoo - - - | - - - nda - - - |
| .. | Iwoy boŋ yagga nda affoo iyye | - - - nda - - - |
| .. | Iwoy boŋ yagga nda affoo yaada | - - - nda - - - |

4. Hinnawey wey deedandi nda <wala> wala = .
90 nda 98 ; 93 nda 95 ; 96 nda 90 ; 91 nda 97 ; 99 nda 98 ;
95 nda 95

* dengari : kaddasu-ize kan i g'a dam jinay ga ka duu k'a bay (étiquette).

Caw : Tontonyan nda kaayan hinnawey ga,
ka hun 90 ka koy 99.

Taasiha : Taaliboo ma hin :

- ka tontonyan tee hinnawey ga ka hun 90 ka koy 99 ;
- ka kaayan tee hinnawey ga ka hun 90 ka koy 99.

Goyjinawey : Wey kaŋ goo sunduku sukantaa ra.

Kabu cahante : 5 hinka tonton 10 ga, marje no ?

Muusa goo nda bonbon 15. A na Aysata noo bonbon 5. Marje ka cindi Muusa se ?

Goyey

Goy jinaa : Bonhaw : Isa na foolo-ize hinka teenay day. A na teenay 45 gar foolo-ize jinaa ra, a na teenay 52 gar ihinkantoo ra. Marje ti Isa teenawey hinnaa ?

Laasaabu : (cawyan banda ga). Alfagaa ma taalibey hãa.

- Teenay foolo marje no Isa day ?
- Teenay marje ma bara foolo-ize jinaa ra ?
- Teenay marje ma bara foolo-ize hinkantoo ra ?
- Macin no ir ga hima k'a ceeci ?
- Kabu cille foo m'ir noo Isa teenawey hinnaa ?
- Hinna foo nda hinna foo n'ir g'i tonton cere ga ?

Alfagaa ma nee i ma goyoo tee.

$$45 + 52 = 97$$

$$\begin{array}{r} 45 \\ + 52 \\ \hline = 97 \end{array}$$

Alfagaa m'i hãa, marje no i duu ? Marje ti iwoy boŋ nda affowey hinnaa ?

Denden : Kabey wey tee.

| | | | | | |
|-------|-------|-------|-------|-------|-------|
| 67 | 59 | 46 | 72 | 81 | 94 |
| + 31 | + 39 | + 50 | + 27 | + 10 | + 5 |
| <hr/> | <hr/> | <hr/> | <hr/> | <hr/> | <hr/> |
| = | = | = | = | = | = |

Goy hinkantoo : Bonhaw : Ali koy saajoo ra, a na garbay 98 kaa kaŋ a yee kate hugey do, a na garbay 35 zamni kayney game. Garbay marje ka cindi Ali kone ?

Laasaabu :

- Garbay marje no Ali duu ey saajoo ra ?
- Marje no a na kayney noo ?
- Macin no bonhawoo nee ir m'a ceeci ?
- Kabu sii foo no ma tee ?
- Hinna foo ma hun hinna foo ra ?

Alfagaa ma nee i ma kaboo hantumoo tee.

$$98 - 35 = 63$$

$$\begin{array}{r} 98 \\ - 35 \\ \hline = \end{array}$$

Denden : Kaayaney wey tee.

| | | | | | |
|-------|-------|-------|-------|-------|-------|
| 92 | 97 | 98 | 94 | 96 | 99 |
| - 21 | - 48 | - 37 | - 19 | - 56 | - 90 |
| <hr/> | <hr/> | <hr/> | <hr/> | <hr/> | <hr/> |
| = | = | = | = | = | = |

Denden

1. Kabey wey hantum m'i timmandi.

| | | | | | |
|------|------|------|------|------|------|
| 42 | .. | 63 | 63 | 91 | 80 |
| + 6 | + 73 | + .. | + 29 | + 7 | + 16 |
| = 98 | = 97 | = 92 | = .. | = .. | = .. |
| 50 | 98 | | | | |
| + 48 | + . | | | | |
| = | = | | | | |

2. Kabey wey hantum m'i tee.

| | | | | | |
|------|------|------|------|------|------|
| 99 | 96 | 92 | 99 | 98 | .. |
| - 64 | - 22 | - 58 | - .. | - .. | - 36 |
| = | = | = | = | = | = |

3. Kabey gorandi m'i tee.

$45 + 52 =$; $62 - 34 =$; $64 + 35 =$; $57 + 40 =$;
 $36 + 58 =$; $93 + 46 =$; $99 - 92 =$; $96 - 48 =$; $95 - 26 =$

4. Bonhaw : Taalibi aru 65 nda woy 32 goo cawhugu foo ra.

Taalibi marje ma bara cawhugoo ra ?

5. Waatoo kan siisihyoo ga tun Tunbutu, boro 40 ka huru a ra. Diirey a na boro 30 zaa, Tonka ra a na boro 10 zaa, Jlafunke ra, boro 19. Boro marje ka huru siisihyoo ra ?

6. Mamadu baaba hun yooboo ra nda bonbon 95 . A na bonbon 40 zamni nga zankey game. Bonbon marje ka cindi Mamadu baaba kone ?

7. Aysata koy yooboo ra nda kaatibi 97. A na kaatibi 54 ka day-day. Kaatibi marje ka cindi Aysata kone ?

Caw : 100 hinnaa

Taasiha : Taaliboo ma hin :

- ka margari-izey hinnaa bay margari ra ;
- ka 100 margari cin, ka 100 caw, k'a hantum nda kabu-ize nda harfu ;
- ka hinnawey hanga-hangandi cere bande ka hun 0 ka koy 100 nda ka hun 100 ka kaa 0 ;
- ka hinnawey durse ka hun 1 ka koy 100.

Goyjinawey : Wey kan goo sunduku sukantaa ra.

Goyey

Goy jinaa : Alfagaa ma nee taalibey ma bundu-ize 90 margari tee nda iwoy bon 9 nda bundu-ize 9. A m'i haa : « bundu-ize marje no » ? A ma yee ka nee taalibey ma bundu-ize 1 sanbu, i m'a tonton margaroo ga. A ma nee i se : « Iwoy bon marje nda bundu-ize marje no i duu sohõ ? (iwoy bon 10). » Alfagaa ma nee : « Woo ti 100. » Taalibey m'a har.

Goy hinkantoo : Alfagaa ma goyoo biyoo tee walhabeeroo ga, taalibey mo m'a tee.

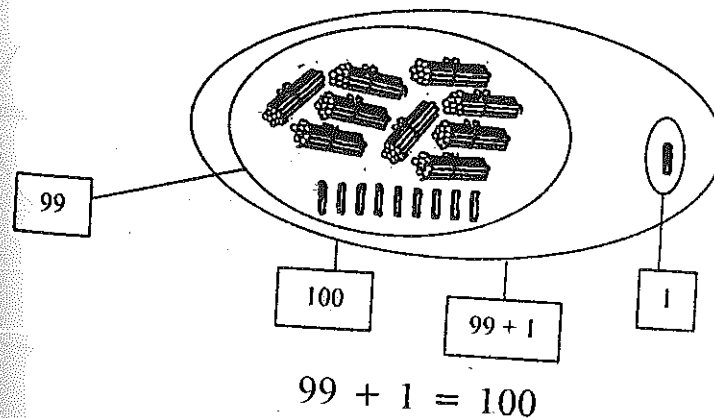

Alfagaa ma woo hantum :

= 100

ey ma zangu caw, i m'a hantum nda kabu-

ndi-ize zaa, ma goy follokaa tee nd'ey, ma

: Wa hinnawey hanga-hangandi cere bande

ka koy ibeeroo ga :

0 ; 10 ; 80 ; 40 ; 60 ; 20.

: Kabu nda 5-5 ka hun 0 ka koy 100 . Kabu

0 ka koy 100, nda ka hun 100 ka doo 0.

da 5-5 ka hun 50 ka koy 100.

da 10-10 ka hun 0 ka koy 100.

da 5-5 ka hun 100 ka doo 80.

mmandi.

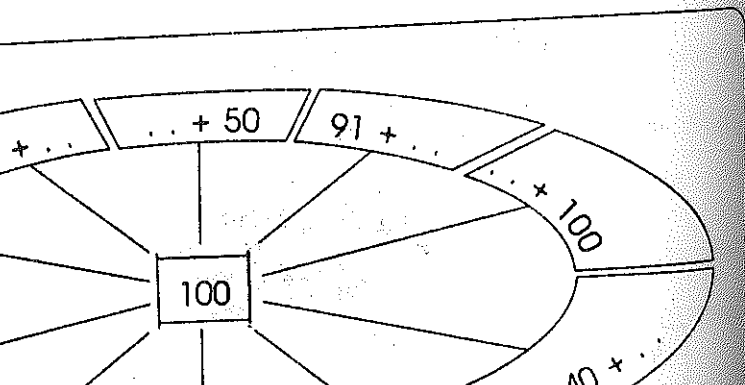

Denden

1. Hantumey wey berandi m'i timmandi.

| | | | | | | | |
|-------|-------|-----|-----|--|--|--|--|
| 100 | 100 | 100 | 100 | | | | |
| zangu | zangu | | | | | | |

2. Zuwey wey tee m'i timmandi.

| | | | | | | | | | |
|------|------|------|------|-----|-----|-----|-----|-----|-----|
| 55 ; | 60 ; | 65 ; | 70 ; | --- | --- | --- | --- | --- | 100 |
|------|------|------|------|-----|-----|-----|-----|-----|-----|

| | | | | | | | | | |
|----|-----|-----|-----|-----|--|--|--|--|-----|
| 0, | 20, | 40, | --- | --- | | | | | 100 |
|----|-----|-----|-----|-----|--|--|--|--|-----|

| | | | | | | | | | |
|------|-----|-----|-----|-----|-----|-----|-----|-----|----|
| 100, | 98, | 96, | --- | --- | --- | --- | --- | --- | 80 |
|------|-----|-----|-----|-----|-----|-----|-----|-----|----|

3. Daaroo tee ma goyoo timmandi.

| | |
|-----|----------|
| 10 | Iwoy |
| 40 | Woytaaci |
| 80 | ----- |
| 100 | ----- |
| 30 | ----- |

Filla : 100 ga

Alfagaa ma nee taalibey ma dendeney wey tee.

Denden

- Hinnawey kul hantum ka hun 85 ka koy 100.
- Hinnawey hantum ka hun 50 ka koy 100, cee foo kul ma 5 tonton.
- Hinnawey deedandi nda <wala> wala =
38 nda 68 ; 90 nda 30 ; 89 nda 98 ; 100 nda 10 ;
55 nda 45 ; 77 nda 66 ; 49 nda 94 ; 72 nda 92.
- Goyoo tee m'a timmandi.
- Daaroo tee m'a timmandi.

| | | |
|-----|----------|----------------|
| 10 | Iwoy | Iwoy boj foo |
| 40 | | |
| 80 | woyyaaha | Iwoy boj yaaha |
| 100 | | |
| 30 | | |

6. Kabey wey hantum, m'i timmandi :

$$\begin{array}{r}
 42 \quad .6 \quad 25 \quad 4. \quad .. \quad 63 \\
 +.6 \quad +.0 \quad +.. \quad +31 \quad +73 \quad +.. \\
 \hline
 = 98 \quad = 76 \quad = 88 \quad = 74 \quad = 97 \quad = 100 \\
 \\
 8. \quad 49 \\
 +15 \quad +.. \\
 \hline
 = 100 \quad = 100
 \end{array}$$

5. Hinnawey hanga-hangandi cere bande ka hun i kul ikaccaa ga ka koy ibeeroo ga :

90, 93, 97, 91, 96, 99, 92, 95, 98.

6. Hinna follokey hanga-hangandi cere bande ka hun i kul ibeeroo ga ka doo ikaccaa ga.

7. Zuwey wey tee, m'i laasaabu, m'i timmandi.

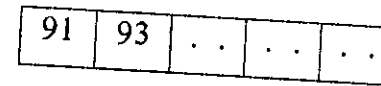
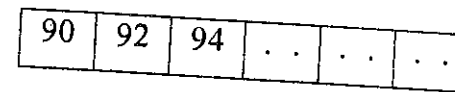

8. Woo berandi, m'a timmandi.

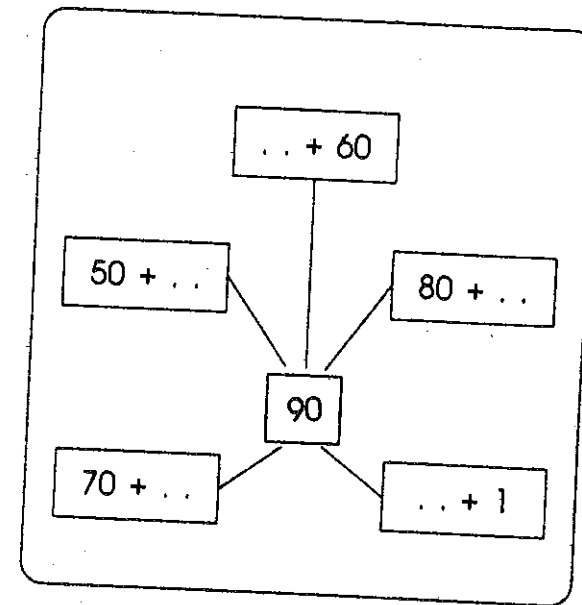

7. Kabey wey suka m'i tee.

$$99 - 64 = \dots ; 66 - 22 = \dots ; 100 - 42 = \dots ; \dots - 35 = 65 ;$$

$$76 - 42 = \dots ; 100 - \dots = 38.$$

8. Hinna 3 nda hinna 4 nda hinna 5 margari tee kaɗ margaroo ga sawa nda 100.

9. Wey timmandi nda $<$, $>$ wala $=$.

| | | |
|-------------------|--------------------|-----------------------|
| $37 \dots 73$ | $50 + 50 \dots 99$ | $100 \dots 50 + 50$ |
| $50 \dots 65$ | $79 \dots 60 + 19$ | $60 + 16 \dots 76$ |
| $48 \dots 40 + 8$ | $98 \dots 80 + 8$ | $90 + 1 \dots 90 + 9$ |

10. Woo timmandi.

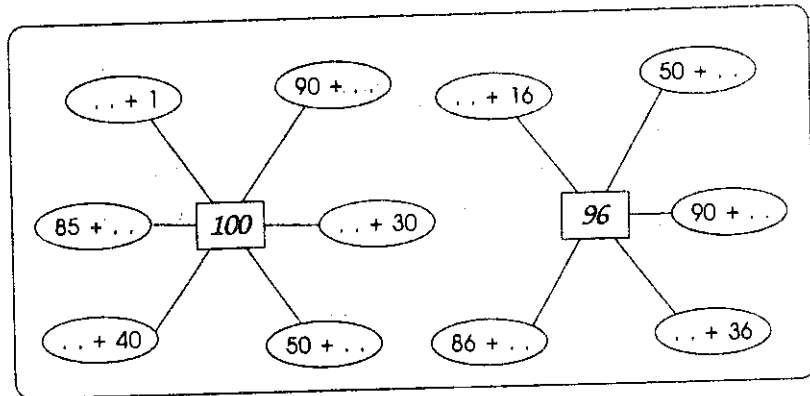

Caw : 100 fesu-fesuyan

Taasiha : Taaliboo ma hin :

- ka 100 fesu-fesu.

Goyjinawey : Wey kaɗ goo sunduku sukantaa ra.

Goyey

Goy jinaa : Alfagaa ma nee taalibey se i ma 100 cin nda 50 margari hinka. A m'i hãa : « 50 margari marje ma bara 100 ra ? »

Marje ka tonton 50 ga ka duu 100 ?

Goy hinkantoo : Alfagaa ma yee ka nee taalibey ma 60 margari tee. A m'i hãa : « Margari marje ma hima ka tonton a ga ka duu 100 ? »

Alfagaa ma kate taalibey ma laasaabu kaɗ 100 ti : $40 + 60$

Denden

1. Duu hinnawey kaɗ ga kuma.

$$100 = 80 + \dots ; 100 = 65 + \dots ; 100 = 48 + \dots ;$$

$$100 = 95 + \dots ; 100 = 39 + \dots ; 100 = 56 + \dots ;$$

$$100 = \dots + 15.$$

2. Kabey wey hantum m'i timmandi.

$$50 + \dots = 100 ; 43 + \dots = 100 ; \dots + 69 = 100 ;$$

$$\dots + 99 = 100 ; 91 + \dots = 100 ; 11 + \dots = 100 ;$$

$$41 + \dots = 100 ; 70 + \dots = 100 ; \dots + 77 = 100.$$

3. Kabey wey timmandi.

$$100 = 10 \text{ marje ? - - -}$$

$$100 = 20 \text{ marje ? - - -}$$











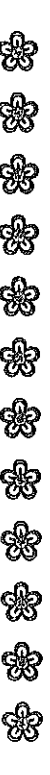

4. Wey hantum, m'i timmandi.

$$100 = 40 + \text{ - - - } + \text{ - - - } + \text{ - - - }; \quad 25 + \text{ - - - } + 39 = 100$$

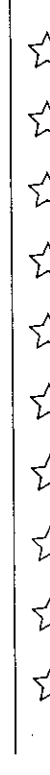
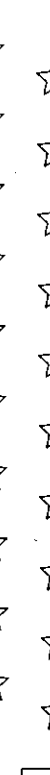
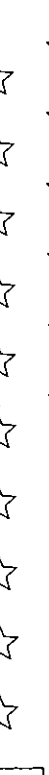
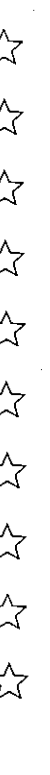
$$100 = 30 + \text{ - - - } + 40; \quad 18 + 56 + \text{ - - - } = 100$$

$$100 = \text{ - - - } + 24 + 48 + 7; \quad 5 + \text{ - - - } + 33 + 19 + \text{ - - - } = 100$$

5. Wey timmandi nda <, > wala =.

| | | | | | | | | | | | | | | | | |
|--|--|--|--|--|--|--|--|--|--|--|--|--|--|--|---|--|
|  |  |  |  |  |  |  |  |  |  |  |  |  |  |  |  |  |
| <input type="text"/> | <input type="text"/> | <input type="text"/> | <input type="text"/> | <input type="text"/> | <input type="text"/> | <input type="text"/> | <input type="text"/> | <input type="text"/> | <input type="text"/> | <input type="text"/> | <input type="text"/> | <input type="text"/> | <input type="text"/> | <input type="text"/> | <input type="text"/> | <input type="text"/> |

DOOBAYRAY

Caw : Jine – banda

Taasiha : Taaliboo ma hin :

- ka jine bay a ma banda bay ;
- ka jinay jisi affoo tana jine wala banda ga.

Goyjinawey : Taalibey, taabaley, tiirawey, hkh.

Goyey

Goy jinaa : Alfagaa ma taalibey hãa nda hayey kaŋ i ga dii ey ngi jine, nda wey kaŋ goo dumawey ga (i m'i cebe) sanda : jine here : walhabeeroo, gorohayaa, hkh ; banda here : sunduku sukantaa, cawdeegarey, biyey, hkh.

Goy hinkantoo : Alfagaa ma nee taalibi foo ma koy kay cerey jine, a ma koy, a ma kaa goyoo ga nda taalibi tana fooyaŋ.

Goy hinzantoo : Alfagaa ma nee taalibi foo ma koy kay cerey se banda ; a ma koy a ma kaa goyoo woo ga nda taalibi tana fooyaŋ.

Goy taacantoo : Alfagaa ma nee taalibi foo kul ma jinay foo jisi nga boŋ jine.

Goy guwantoo : Alfagaa ma nee taalibi foo kul ma jinay foo jisi nga boŋ banda ga.

Goy idduwantoo : Alfagaa ma nee taalibi foo se, a ma koy kay taabaloo, wala ganboo, wala sunda

Goy iyyantoo : Alfagaa ma nee taalibi foo se, a ma koy nga walhaa jisi biibataa bandaa ga wala jinoo ra. Alfagaa ma goyoo filla nda taalibi fooyan ; a ga jinawey barmay-barmay.

Goy yaahantoo : Alfagaa ma nee taalibey ma duu himakasinayyan nonguyan ra kan man'ti cawhugoo gundoo waney.

Denden

1. Taalibey ma bugu tee, alfagaa ma nee taalibey ma tammaasa dam bugoo jine.
2. Taalibey ma zeeri ciray tee, i ma zeeri kaaray dam bandaa ga.
3. Bugu foo tee, ma tuuri dam a jine.

N.B : Alfagaa ma kookari jinay kul masi bara taabaley bog cawoo sintinoo ga.

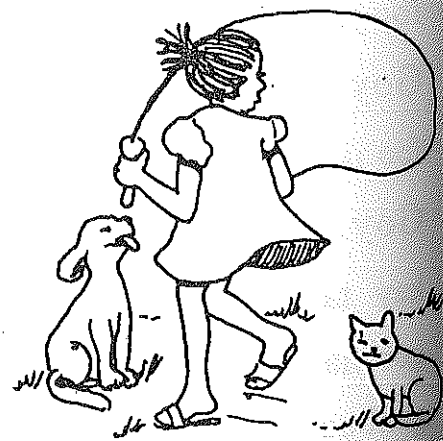

Caw : Kanbe guma* – kanbe wowa*

- Taasiha : Taaliboo ma hin :
- ka nongu guma nda nongu wowa bay nga bon ga ;
 - ka boro foo tana nongu gumaa nda nga nongu wowaa fay k'i kaa cere ra ;
 - ka haya jisi affoo tana ceraw gumaa wala ilaalaa here.

Goyjinawey : taalibey, bal.

Goyey

Goy jinaa : Alfagaa ma kay wallabeeroo jeroo ga, a ma banda fur zankey se, a ma nga kanbe gumaa cebe i se, a ma filla ka nga kanbe wowaa mo cebe i se. A ma nee taalibey se : wa war kanbe gumawey jer, wa war kanbe wowey jer.

Goy hinkantoo : Alfagaa ma nee taalibi foo ma baloo kar nda nga cewoo ; a ma hãa wala cee foo nda a na baloo kar.

Goy hinzantoo : Alfagaa ma wiri taalibi foo kul ga, a ma nongu cebe nga jere gumaa ra wala nga jere laalaa ra. A ma taalibey hãa wala kanbe foo nda ngi hunday ga bii tee, wala cee foo nda i ga bal kar.

Goy taacantoo : Taalibi foo ma kanbe gumaa wala cee gumaa wala haya tana cebe nga cere foo ga kan ga дума tee a se.

Goy guwantoo : Alfagaa ma zankey kul kayandi, a ga nee i se : iwoy, igum. Taalibey ga cewey wala kanbey jer alfagaa senney bande.

Goy idduwantoo : Taaliboo ma zeeri foo tee, a ma windira tee kanbe gumaa nda ilaalaa here.

Denden

1. Tuuri foo tee, ma zeeri foo dam ceraw gumaa here, ma zeeri hinka dam ceraw wowaa here.
2. Bal foo tee ma tammaasa dam ceraw gumaa here.
3. Ni kanbe wowaa biyoo tee.
4. Bugu bii tee, ma tinda bii tee kanbe wowaa here.
5. Soo bii tee ma poti bii tee kanbe gumaa here.

Kalima sendey :

Kanbe guma : Kanbe borya.

Kanbe wowa : Kanbe laala.

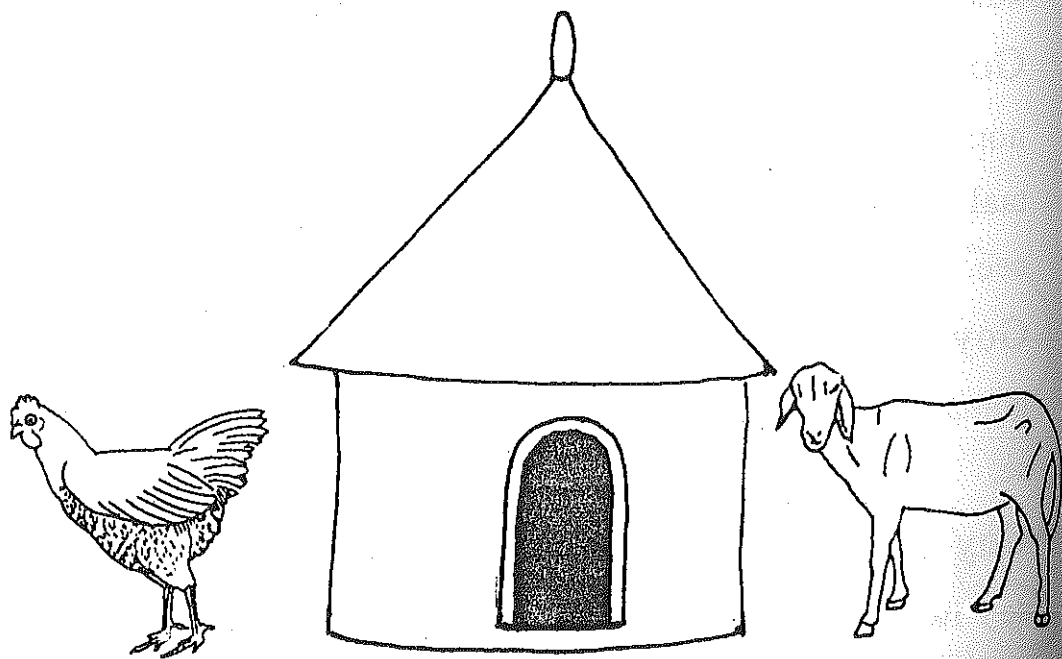

Caw : Kuna/ra – taray

Taasiha : Taaliboo ma hin :

- ka bay wala jinay goo kuna wala taray ;
- ka huru kuna wala ka fatta taray ;
- ka jinay dam kuna wala taray ;
- ka windi kuna wala taray bay ;
- ka haya kul kunaa wala taraa bay.

Goyjinawey : karfu, kusu, soo, hari, feraw, tondi-ize, tiira, baaji, kalam, ziiba, nooru, hkh.

Goyey

Goy jinaa : Alfagaa ma jinay daabantayan fur taabaloo ga. A m'i cebe taalibey se. (kusu, baaji, soo). A ma tondi-ize dam kusoo ra. Alfagaa ma taalibi foo hãa wala man ra tondi-izoo goo. (kusoo ra, gundoo ra). A ma takaa woo da tee nda taalibi fooyan.

Goy hinkantoo : Alfagaa ma nee taaliboo ma tondi-izoo kaa kusoo ra. A m'a hãa wala man ra a goo kusoo se (taray). A ma takaa woo da tee nda taalibi fooyan.

Goy hinzantoo : Alfagaa ma taalibiyay cee, i ma kali tee. Taalibi foo ma huru kaloo ra. Alfagaa m'a hãa wala man ra a goo (kaloo ra). Alfagaa ma nee taaliboo se a ma fatta kaloo ra. A m'a hãa wala man ra a goo (taray). Alfagaa ma takaa woo da tee nda taalibi fooyan.

Goy taacantoo : Alfagaa ma windira foo tee laboo ga. A ma nee taalibiyay se i ma huru a ra. A ma nee affooyay se i ma yee taray. A ma taalibi foo kul hāa nda nga dogoo windiraa se.

- Alfagaa ma yee ka nee taalibey se, i ma tondi-ize jisi windiraa kuna wala a se taray.

Goy guwantoo : Alfagaa ma taalibi foo sanba a ma windira foo tee walhabeeroo ga. Taaliboo ma zeeri foo tee windiraa gundoo ra, a ma zeeri hinka tee windiraa se taray. Alfagaa ma taalibi booboyay sanba, i ma takaa woo da filla.

Goy idduwantoo : Alfagaa ma taalibi foo sanba walhabeeroo do. A ma windira foo tee, a ma gundoo noone. Alfagaa ma takaa woo filla nda taalibi booboyay.

Denden

1. Zeeri daabante foo tee, ma koli foo dam a kuna.

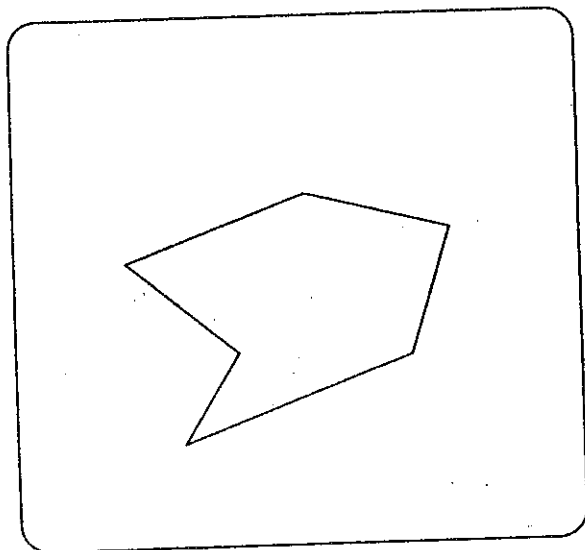

2. Zeeri daabantaa woo tee, ma X tee a se taray.

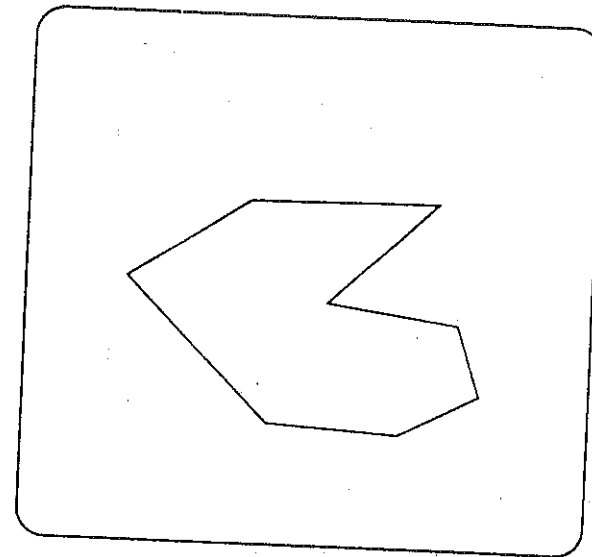

3. O tee kaarewoo woo se taray.

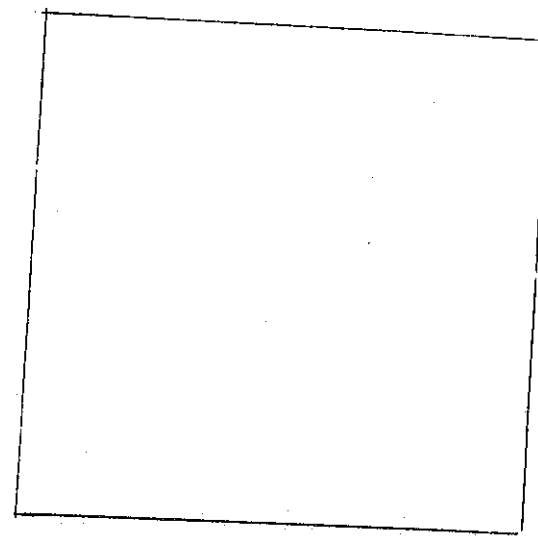

woo kuna.

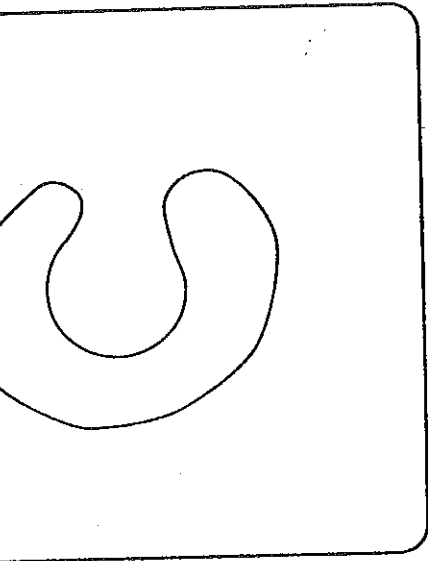

aaabantey wey kuna.

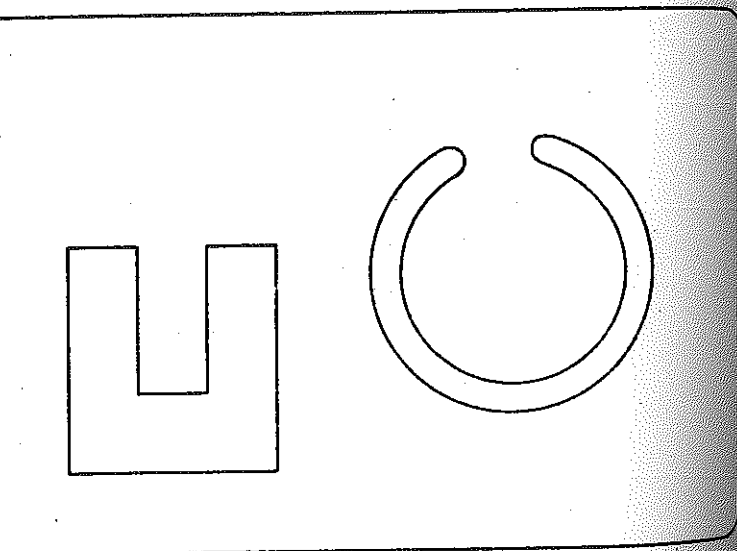

a kanjehinza foo tee a kuna.

Caw : Beene – ganda ; beene here – ganda here

Taasiha : Taliboo ma hin :

- ka haya beene heroo nda ganda heroo bay ;
- ka haya cebe kanj goo affoo tana se beene wala a se ganda.

Goyjinawey : Taalibey, alfagaa, walhawey, walhabeeroo, tiira, kalam, baaji, galankaaru.

Goyey

Goy jinaa : Alfagaa ma nee taalibey ma sunduku sukantaa beene heroo cebe i ma nga ganda heroo cebe. Alfagaa ma nee i m'a filla nda jinay foo tanayanj : walhabeeroo, taabaloo, biibataa, alfagaa gorohayaa.

- Alfagaa ma nee taalibey ma jinay foo tanayanj beene herey cebe i ma ngi ganda herey cebe.

Goy hinkantoo : Alfagaa ma nee taalibey se i ma ngi walhawey suka. I ma walhawey beene herey nda ngi ganda herey cebe.

Goy hinzantoo : Taalibey ma gunguli tee walhabeeroo beene heroo ga, i ma kaare tee walhabeeroo ganda heroo ga.

Goy taacantoo : Alfagaa ma nee taalibey ma duu ngi himakasineyanj nonguyan ra.

Goy idduwantoo : Alfagaa ma taalibi foo sanba

Denden

1. Bugu tee, ma zeeri foo tee a se beene, ma zeeri hinka tee a se ganda.

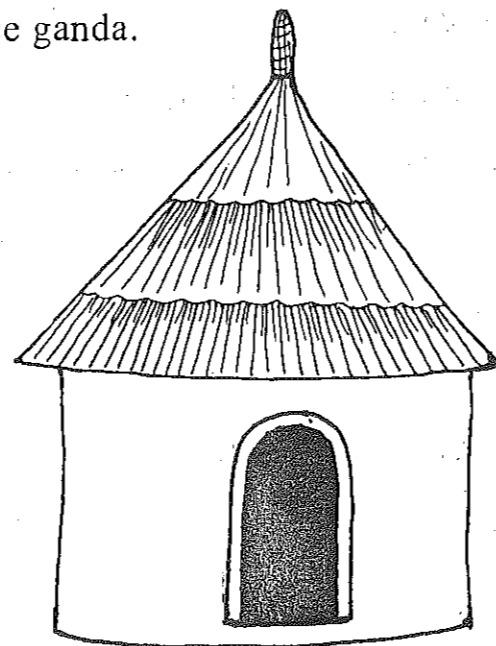

2. Kaare hinka tee kaŋ goo cere boŋ. Gunguli tee woo kaŋ goo beene boŋ, ma zeeri tee woo kaŋ goo ganda cire.

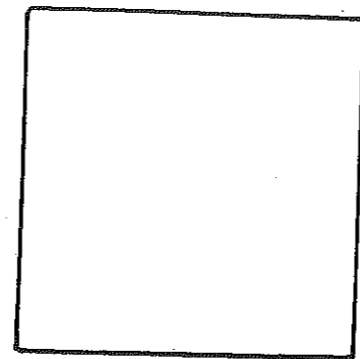
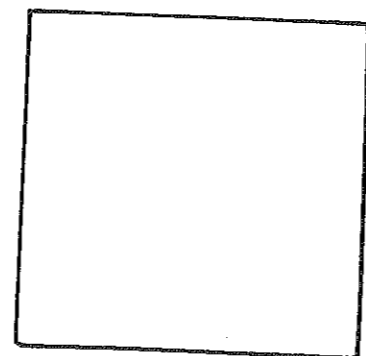

3. Zeeri tee. Kusu tee a se beene, ma hamiisa tee a se ganda.



4. Tuuri tee kaŋ ciraw foo g'a boŋ, hayla g'a cire.

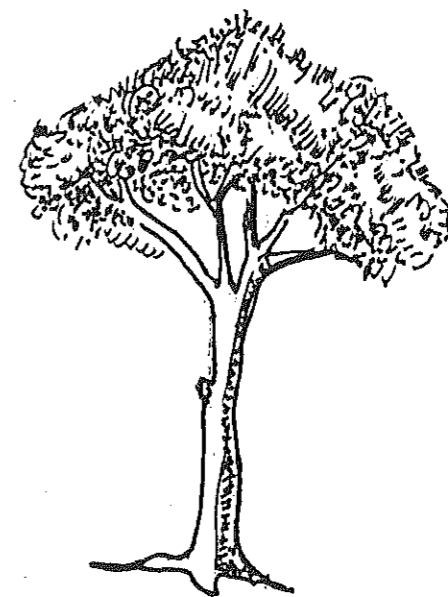

5. Moobil tee, ma gunguli foo dam a se beene, ma X dam a se ganda.

